



TEST REPORT

EN 50549-1:2019

**Requirements for generating plants to be connected in parallel
with distribution networks - Part 1-1:
Connection to a LV distribution network - Generating plants up
to and including Type B**

Report reference number : **PV200302N015-9**

Date of issue : 2020-08-28

Total number of pages : 174

Testing laboratory name : **Bureau Veritas Shenzhen Co., Ltd. Dongguan Branch**

Address : No. 96, Guantai Road (Houjie Section), Houjie Town, Dongguan City, Guangdong Province, 523942, People's Republic of China

Accreditation :



Applicant's name : **Shenzhen SOFAR SOLAR Co., Ltd.**

Address : 401, Building 4, AnTongDa Industrial Park, District 68, XingDong Community, XinAn Street, BaoAn District, Shenzhen, China

Test specification

Standard..... : EN 50549-1:2019
with deviations according to C10/11:2019 for Belgium
"Specific technical prescription regarding power-generating plants
operating in parallel to the distribution network"

Test Report Form No. : EN 50549-1 VER.0

TRF Originator : Bureau Veritas Shenzhen Co., Ltd. Dongguan Branch

Master TRF : Dated 2019-12-11

Test item description..... : **Hybrid inverter**



Trademark..... :



This report is governed by, and incorporates by reference, CPS Conditions of Service as posted at the date of issuance of this report at <http://www.bureauveritas.com/home/about-us/our-business/cps/about-us/terms-conditions> and is intended for your exclusive use. Any copying or replication of this report to or for any other person or entity, or use of our name or trademark, is permitted only with our prior written permission. This report sets forth our findings solely with respect to the test samples identified herein. The results set forth in this report are not indicative or representative of the quality or characteristics of the lot from which a test sample was taken or any similar or identical product unless specifically and expressly noted. Our report includes all of the tests requested by you and the results thereof based upon the information that you provided to us. Measurement uncertainty is only provided upon request for accredited tests. You have 60 days from date of issuance of this report to notify us of any material error or omission caused by our negligence or if you require measurement uncertainty; provided, however, that such notice shall be in writing and shall specifically address the issue you wish to raise. A failure to raise such issue within the prescribed time shall constitute your unqualified acceptance of the completeness of this report, the tests conducted and the correctness of the report contents.

Model / Type	HYD 20KTL-3PH, HYD 15KTL-3PH, HYD 10KTL-3PH, HYD 8KTL-3PH, HYD 6KTL-3PH, HYD 5KTL-3PH		
Ratings	HYD 10KTL-3PH	HYD 15KTL-3PH	HYD 20KTL-3PH
Full load MPP DC voltage range [V] :	220-850V	350-850V	450-850V
Input DC voltage range[V]..... :	180-960V		
Input DC current [A]	Max. 25.0 x 2		
Output AC voltage [V]	3/N/PE, 230/400,50Hz		
Output AC current [A]..... :	16	24	32
Output power [VA]..... :	11000	16500	22000
Output DC voltage range [V]..... : [Battery charge]..... :	180-800V		
Input DC current [A]	Max. 25A*2		
[Battery charge]..... :	Max. 25A*2		
Output DC current [A]..... : [Battery discharge]..... :	Max. 25A*2		
Charge and discharge power[VA]..... :	11000	16500	22000
Output AC voltage [V]	3/N/PE, 230/400,50Hz		
Output AC current [A]..... :	16	24	32
Output power [VA]..... :	Max. 11000	Max. 16500	Max. 22000
Ratings	HYD 8KTL-3PH	HYD 6KTL-3PH	HYD 5KTL-3PH
Full load MPP DC voltage range [V] :	360V-850	320-850	250-850
Input DC voltage range[V]..... :	180-960		
Input DC current [A]	Max. 12.5 x 2		
Output AC voltage [V]	3/N/PE, 230/400,50Hz		
Output AC current [A]..... :	13	10	8
Output power [VA]..... :	Max. 8800	Max. 6600	Max. 5500
Output DC voltage range [V]..... : [Battery charge]..... :	180-800V		
Input DC current [A]	Max. 25A		
[Battery charge]..... :	Max. 25A		
Output DC current [A]..... : [Battery discharge]..... :	Max. 25A		
Charge and discharge power[VA]..... :	Max. 8800	Max. 6600	Max. 5500
Output AC voltage [V]	3/N/PE, 230/400,50Hz		
Output AC current [A]..... :	13	10	8
Output power [VA]..... :	Max. 8800	Max. 6600	Max. 5500



Testing Location	Bureau Veritas Shenzhen Co., Ltd. Dongguan Branch
Address	No. 96, Guantai Road (Houjie Section), Houjie Town, Dongguan City, Guangdong Province, 523942, People's Republic of China
Tested by (name and signature).....	Lukes Lin 
Approved by (name and signature).....	James Huang 
Manufacturer's name.....	Shenzhen SOFAR SOLAR Co., Ltd.
Manufacturer address	401, Building 4, AnTongDa Industrial Park, District 68, XingDong Community, XinAn Street, BaoAn District, Shenzhen, China
Factory's name.....	Dongguan SOFAR SOLAR Co.,Ltd.
Factory address	1F - 6F, Building E, No. 1 JinQi Road, Bihu Industrial Park, Wulian Village, Fenggang Town, Dongguan City, Guangdong, China.



BUREAU
VERITAS

Report No.: PV200302N015-9

Document History			
Date	Internal reference	Modification / Change / Status	Revision
2020-08-28	Lukes Lin	Initial report was written	0
Supplementary information:			

Test items particulars

Equipment mobility : Permanent connection
 Operating condition : Continuous
 Class of equipment : Class I
 Protection against ingress of water .. : IP65 according to EN 60529
 Mass of equipment [kg] : Approx. 33kg for HYD 5KTL-3PH, HYD 6KTL-3PH, HYD 8KTL-3PH,
 Approx. 37kg for HYD 10KTL-3PH, HYD 15KTL-3PH, HYD 20KTL-3PH

Test case verdicts

Test case does not apply
 to the test object : N/A
 Test item does meet
 the requirement : P(ass)
 Test item does not meet
 the requirement : F(ail)

Testing

Date of receipt of test item : 2020-03-02
 Date(s) of performance of test : 2020-03-02 to 2020-08-21

General remarks:

The test result presented in this report relate only to the object(s) tested. The report shall state compliance of the tested objects with the requirements of EN 50549-1. This report shall not be reproduced in part or in full without the written approval of the issuing testing laboratory.

"(see Annex #)" refers to additional information appended to the report.

"(see appended table)" refers to a table appended to the report.

Throughout this report a comma is used as the decimal separator.

This Test Report consists of the following documents:

1. Test Report
 - 4.4 Normal operating range
 - 4.5 Immunity to disturbances
 - 4.6 Active response to frequency deviation
 - 4.7 Power response to voltage variations and voltage changes
 - 4.8 EMC and power quality
 - 4.9 Interface protection
 - 4.10 Connection and starting to generate electrical power
 - 4.11 Ceasing and reduction of active power on set point
 - 4.13 Requirements regarding single fault tolerance of interface protection system and interface switch
2. Annex No. 1 – Pictures of the unit
3. Annex No. 2 – Test equipment list

Copy of marking plate

SOFAR
SOLAR
Hybrid Inverter

Model No: HYD 5KTL-3PH

Max.DC Voltage	1000V
MPPT Voltage Range	180~960V
Max. Input Current	12.5/12.5A
Max.PV Isc	15/15A
Battery Type	Li-Ion
Battery Voltage Range	180~800V
Battery Max. Charging Current	25A
Battery Max. Discharging Current	25A
Nominal Grid/Back-up Voltage	3/N/PE, 380/400V
Nominal Grid/Back-up Frequency	50/60Hz
Max. Current Output to Grid	8A
Max. Power Output to Grid	5500VA
Max. Current from Grid	15A
Max. Power from Grid	10000VA
Back-up Max. Output Current	8A
Back-up Max. Output Power	5500VA
Power Factor	1(adjustable+/-0.8)
Operating Temperature Range	-30~+60°C
Ingress Protection	IP65
Protective Class	Class I
Inverter Topology	Non-isolated
Overvoltage Category	AC III,DC II

Manufacturer : Shenzhen SOFAR SOLAR Co.,Ltd.
Address : 401, Building 4, AnTongDa Industrial Park,
District 68, XingDong Community,XinAn Street,
BaoAn District, Shenzhen, China

SAA VDE0126-1-1,VDE-AR-N4105
G98,G99,EN50438,AS4777,UTE C15-712-1



SOFAR
SOLAR
Hybrid Inverter

Model No: HYD 6KTL-3PH

Max.DC Voltage	1000V
MPPT Voltage Range	180~960V
Max. Input Current	12.5/12.5A
Max.PV Isc	15/15A
Battery Type	Li-Ion
Battery Voltage Range	180~800V
Battery Max. Charging Current	25A
Battery Max. Discharging Current	25A
Nominal Grid/Back-up Voltage	3/N/PE, 380/400V
Nominal Grid/Back-up Frequency	50/60Hz
Max. Current Output to Grid	10A
Max. Power Output to Grid	6600VA
Max. Current from Grid	17A
Max. Power from Grid	12000VA
Back-up Max. Output Current	10A
Back-up Max. Output Power	6600VA
Power Factor	1(adjustable+/-0.8)
Operating Temperature Range	-30~+60°C
Ingress Protection	IP65
Protective Class	Class I
Inverter Topology	Non-isolated
Overvoltage Category	AC III,DC II

Manufacturer : Shenzhen SOFAR SOLAR Co.,Ltd.
Address : 401, Building 4, AnTongDa Industrial Park,
District 68, XingDong Community,XinAn Street,
BaoAn District, Shenzhen, China

SAA VDE0126-1-1,VDE-AR-N4105
G98,G99,EN50438,AS4777,UTE C15-712-1



SOFAR
SOLAR
Hybrid Inverter

Model No: HYD 8KTL-3PH

Max.DC Voltage	1000V
MPPT Voltage Range	180~960V
Max. Input Current	12.5/12.5A
Max.PV Isc	15/15A
Battery Type	Li-Ion
Battery Voltage Range	180~800V
Battery Max. Charging Current	25A
Battery Max. Discharging Current	25A
Nominal Grid/Back-up Voltage	3/N/PE, 380/400V
Nominal Grid/Back-up Frequency	50/60Hz
Max. Current Output to Grid	13A
Max. Power Output to Grid	8800VA
Max. Current from Grid	24A
Max. Power from Grid	16000VA
Back-up Max. Output Current	13A
Back-up Max. Output Power	8800VA
Power Factor	1(adjustable+/-0.8)
Operating Temperature Range	-30~+60°C
Ingress Protection	IP65
Protective Class	Class I
Inverter Topology	Non-isolated
Overvoltage Category	AC III,DC II

Manufacturer : Shenzhen SOFAR SOLAR Co.,Ltd.
Address : 401, Building 4, AnTongDa Industrial Park,
District 68, XingDong Community,XinAn Street,
BaoAn District, Shenzhen, China

SAA VDE0126-1-1,VDE-AR-N4105
G98,G99,EN50438,AS4777,UTE C15-712-1



SOFAR
SOLAR
Hybrid Inverter

Model No: HYD 10KTL-3PH



Max.DC Voltage	1000V
MPPT Voltage Range	180~960V
Max. Input Current	25/25A
Max.PV Isc	30/30A
Battery Type	Li-Ion
Battery Voltage Range	180~800V
Battery Max. Charging Current	25/25A
Battery Max. Discharging Current	25/25A
Nominal Grid/Back-up Voltage	3/N/PE, 380/400V
Nominal Grid/Back-up Frequency	50/60Hz
Max. Current Output to Grid	16A
Max. Power Output to Grid	11000VA
Max. Current from Grid	29A
Max. Power from Grid	20000VA
Back-up Max. Output Current	16A
Back-up Max. Output Power	11000VA
Power Factor	1(adjustable+/-0.8)
Operating Temperature Range	-30~+60°C
Ingress Protection	IP65
Protective Class	Class I
Inverter Topology	Non-isolated
Overvoltage Category	AC III,DC II



Manufacturer : Shenzhen SOFAR SOLAR Co.,Ltd.
Address : 401, Building 4, AnTongDa Industrial Park,
District 68, XingDong Community,XinAn Street,
BaoAn District, Shenzhen, China

SAA VDE0126-1-1,VDE-AR-N4105
G98,G99,EN50438,AS4777,UTE C15-712-1



Copy of marking plate

 Hybrid Inverter	
Model No:	HYD 15KTL-3PH
Max.DC Voltage	1000V
MPPT Voltage Range	180~960V
Max. Input Current	25/25A
Max.PV Isc	30/30A
Battery Type	Li-Ion
Battery Voltage Range	180~800V
Battery Max. Charging Current	25/25A
Battery Max. Discharging Current	25/25A
Nominal Grid/Back-up Voltage	3/N/PE, 380/400V
Nominal Grid/Back-up Frequency	50/60Hz
Max. Current Output to Grid	24A
Max. Power Output to Grid	16500VA
Max. Current from Grid	44A
Max. Power from Grid	30000VA
Back-up Max. Output Current	24A
Back-up Max. Output Power	16500VA
Power Factor	1(adjustable+/-0.8)
Operating Temperature Range	-30~+60°C
Ingress Protection	IP65
Protective Class	Class I
Inverter Topology	Non-isolated
Overvoltage Category	AC III,DC II
Manufacturer : Shenzhen SOFAR SOLAR Co.,Ltd. Address : 401, Building 4, AnTongDa Industrial Park, District 68, XingDong Community,XinAn Street, BaoAn District, Shenzhen, China	
SAA VDE0126-1-1,VDE-AR-N4105 G98,G99,EN50438,AS4777,UTE C15-712-1	
	

 Hybrid Inverter	
Model No:	HYD 20KTL-3PH
Max.DC Voltage	1000V
MPPT Voltage Range	180~960V
Max. Input Current	25/25A
Max.PV Isc	30/30A
Battery Type	Li-Ion
Battery Voltage Range	180~800V
Battery Max. Charging Current	25/25A
Battery Max. Discharging Current	25/25A
Nominal Grid/Back-up Voltage	3/N/PE, 380/400V
Nominal Grid/Back-up Frequency	50/60Hz
Max. Current Output to Grid	32A
Max. Power Output to Grid	22000VA
Max. Current from Grid	58A
Max. Power from Grid	40000VA
Back-up Max. Output Current	32A
Back-up Max. Output Power	22000VA
Power Factor	1(adjustable+/-0.8)
Operating Temperature Range	-30~+60°C
Ingress Protection	IP65
Protective Class	Class I
Inverter Topology	Non-isolated
Overvoltage Category	AC III,DC II
Manufacturer : Shenzhen SOFAR SOLAR Co.,Ltd. Address : 401, Building 4, AnTongDa Industrial Park, District 68, XingDong Community,XinAn Street, BaoAn District, Shenzhen, China	
SAA VDE0126-1-1,VDE-AR-N4105 G98,G99,EN50438,AS4777,UTE C15-712-1	
	

General product information:

The inverter converts DC voltage, generated by photovoltaic modules, into AC voltage.
The units are three-phases inverter.
Rate of change of frequency (RoCoF) detection was used for LOM protection.

Description of the power circuit (Figure 1):

The hybrid inverter converts DC voltage, generated by photovoltaic modules and batteries, into AC voltage. The input and output are protected by Varistors to Earth. The unit is providing EMC filtering at the input and output toward mains. The unit does not provide galvanic separation from input to output (transformerless). The output is switched off redundant by the high power switching bridge and a two relays. This assures that the opening of the output circuit will also operate in case of one error.

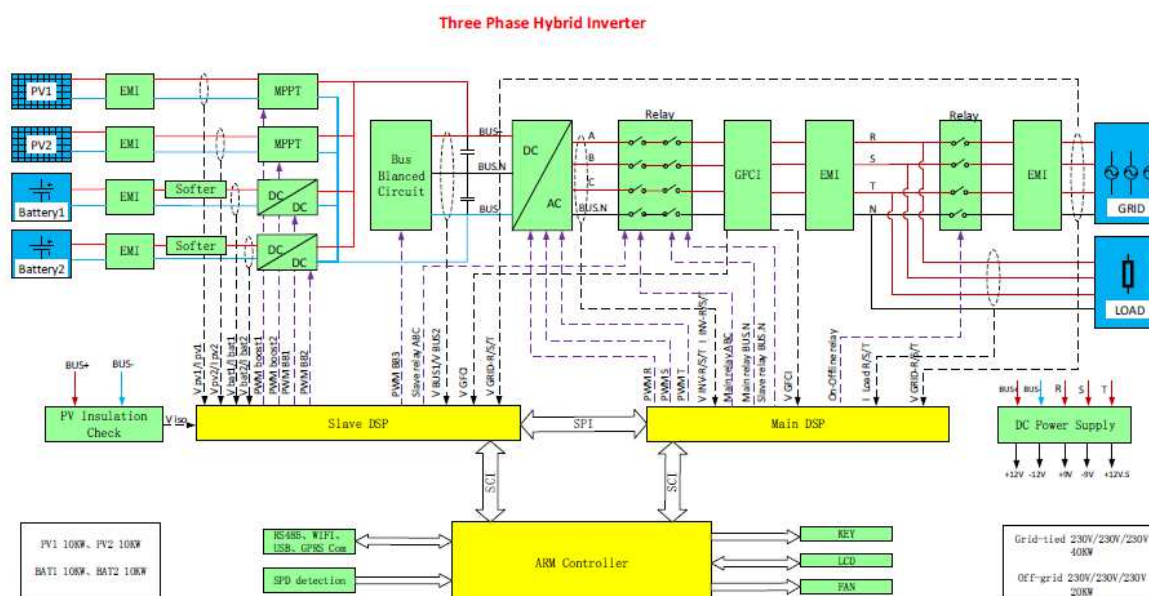

Figure 1 – Block diagram

The internal control is redundant built. It consists of master DSP(U37) and slave DSP(U39).

The master DSP (U37) control the relays by switch signals, measures PV voltage, PV current, Bus voltage, grid voltage, frequency, AC current with injected DC and the array insulation resistance to ground, in addition it tests the array insulation resistance and the RMCU circuit before each start up.

The slave DSP (U39) is measures the grid voltage, grid frequency and residual current , also can switch off the relays independently, and communicate with master DSP (U39).

The current is measured by a current sensor. The AC current signal and the injected DC current signal are sent to the Main DSP(U37). The Mian DSP(U37) tests and calibrates before each start up all current sensors.

The unit provides two relays in series in all output conductors. When single-fault applied to one relay, alarm an error code in display panel, another redundant relay provides basic insulation maintained between the PV array and the mains. All the relays are tested before start up. Both DSPs can open the relays.

Differences of the models:

The models HYD 5KTL-3PH, HYD 6KTL-3PH, HYD 8KTL-3PH, HYD 10KTL-3PH, HYD 15KTL-3PH and HYD 20KTL-3PH are completely identical and output power derated by software, except for the following table.

	HYD 5KTL-3PH	HYD 6KTL-3PH	HYD 8KTL-3PH	HYD 10KTL-3PH	HYD 15KTL-3PH	HYD 20KTL-3PH
INV inductor	1,5 mH		1,12 mH		0,876 mH	
BOOST inductor	1,8 mH			0,915 Mh		
Fan	Without			With		

The product was tested on:

Hardware version: V1.0

Software version: V2.00 e superiore

General remarks:

The test results presented in this report relate only to the object(s) tested.

This document may be published or passed on in full only. Extraction of parts needs the written permission of Bureau Veritas Consumer Products Services GmbH.

"(see Annex #)" refers to additional information appended to the report.

"(see appended table)" refers to a table appended to the report.

Throughout this report a comma is used as the decimal separator.

The following suffixes are used for variables in tables and figures:

- "P_n" for the nominal active power:
 $P_n = U_n \times I_n \times \cos \varphi_n$ (single-Phase); $P_n = \sqrt{3} U_n \times I_n \times \cos \varphi_n$ (three-Phase)
- "P_M" for the momentary power
- "(c)" for over-excited
- "(i)" for under-excited

Active and reactive power:

The regarded system of the voltage and current vectors is the load view (Figure 2):

- If the inverter feeds to the grid the active power is measured with negative sign. For the sake of reading the document the measured active infeed power has a positive sign

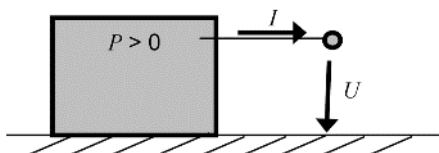

- If the inverter consumes inductive reactive power the reactive power is marked "inductive" or has a positive sign.
- If the inverter consumes capacitive reactive power the reactive power is marked "capacitive" or has a negative sign.

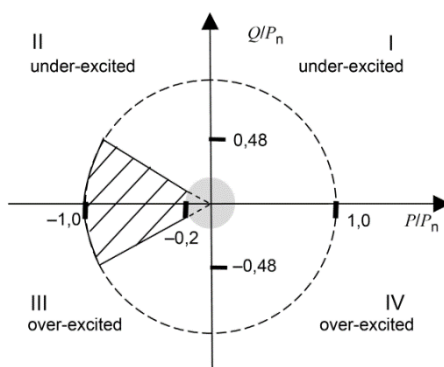

Figure 2

Default interface protection settings according EN 50549-1:2019:

Parameter	Max. disconnection time	Min. operate time	Trip value
Over voltage – stage 1	3 s	0,1 s	230V +10% (253,0 V)
Over voltage – stage 2	0,2 s	0,1 s	230V +15% (264,5 V)
Under voltage – stage 1	1,5 s	1,2 s	230V -15% (195,5V)
Over frequency	0,5 s	0,3 s	52 Hz
Under frequency	0,5 s	0,3 s	47,5 Hz
Reconnection settings for voltage	$0,85 U_n \leq U \leq 1,10 U_n$		
Connection settings for frequency (Normal operational start-up)	$49,5 \text{ Hz} \leq f \leq 50,1 \text{ Hz}$		
Reconnection settings for frequency (Automatic reconnection after tripping)	$49,5 \text{ Hz} \leq f \leq 50,2 \text{ Hz}$		
Reconnection time	$\geq 60 \text{ s}$		
Active power gradient after reconnection	$10\% P_n/\text{min}$		
Permanent DC-injection	0,5% of rated inverter output current or 20mA		
Loss of mains according EN 62116	Inverter shall disconnect within 2 s.		
<p>The stated currents and voltages are 'true r.m.s.'-values.</p> <p>The voltages in this table are</p> <ul style="list-style-type: none"> - phase-to-neutral in 230 V single phase systems and 230/400 V systems, - phase-to-phase in a multiphase 230 V system. 			
<p>Tolerances on trip values:</p> <ul style="list-style-type: none"> - Voltage: $\pm 1\%$ of U_n - Frequency: $\pm 0,05 \text{ Hz}$ - Disconnection time : $\pm 10\%$ 			

The following deviations for Belgium (C10/11) have been applied according the EN 50549-1:2019:

Parameter	Max. disconnection time	Trip value
Over voltage – stage 1 ^a	0,2 s	230V +10% (253 V)
Over voltage – stage 2	0,2 s	230V +15% (264,5 V)
Under voltage ^a	0,2 s	230V -20% (184V)
Over frequency	0,2 s	51,5 Hz
Under frequency	0,2 s	47,5 Hz
Reconnection settings for voltage	$0,85 U_n \leq U \leq 1,10 U_n$	
Connection settings for frequency (Normal operational start-up)	$49,9 \text{ Hz} \leq f \leq 50,1 \text{ Hz}$	
Reconnection settings for frequency (Automatic reconnection after tripping)	$49,9 \text{ Hz} \leq f \leq 50,1 \text{ Hz}$	
Active power gradient normal operation starting	20%P _n /min	
Active power gradient after tripping	10%P _n /min	
Reconnection time	≥ 60 s	
Loss of mains according EN 621 16 (LoM)	Inverter shall disconnect within 2s.	
^a Over voltage – stage1: 10 min-mean-value corresponding to EN 50160.		

EN 50549:2019, clause 4: Tests

Clause	Test requirement (According to table C.1)	Result
4.4	Normal operating range	P
4.5	Immunity to disturbances	P
4.6	Active response to frequency deviation	P
4.7	Power response to voltage variations and voltage changes	P
4.8	EMC and power quality	P
4.9	Interface protection	P
4.10	Connection and starting to generate electrical power	P
4.11	Ceasing and reduction of active power on set point	P
4.12	Remote information exchange	N/A
4.13	Requirements regarding single fault tolerance of interface protection system and interface switch	P

EN 50549-1:2019: Normal operating range

Clause	Test requirement	Test procedure according standard	Result
4.4.2	Power response to over-frequency	EN 50438, Annex D.3.1	P
4.4.3	Power response to under-frequency	G99/1-4, clause A.7.3.2	P
4.4.4	Continuous operating voltage range	EN 50438, Annex D.3.1	P

4.4.2 Operating frequency range					P
4.4.4 Continuous operating voltage range					
Setting values	Over-voltage [V]:				253
	Under-voltage [V]:				195,5
	Over-frequency [Hz]:				51,5
	Under-frequency [Hz]:				47,5
<ul style="list-style-type: none"> - Test 1: U = 195,5 V; f = 47,5 Hz; P = 1,00 S_n; cosφ = 1 - Test 2: U = 195,5 V; f = 48,5 Hz; P = 1,00 S_n; cosφ = 1 - Test 3: U = 253,0 V; f = 51,5 Hz; P = 1,00 S_n; cosφ = 1 - Test 4: U = 230,0 V; f = 50,0 Hz; Voltage Phase jumps Change +20 degrees P = 1,00 S_n; cosφ = 1 - Test 5: U = 230,0 V; f = 50,0 to 50,5 Hz; RoCoF=1Hz/s; P = 1,00 S_n; cosφ = 1 					
Test result:					
Test sequence	Voltage [V]	Frequency [Hz]	Output power [kW]	Cos φ	
Test1	195,52	47,50	19,937	0,9972	
Test2	195,49	48,50	19,933	0,9985	
Test3	25,29	51,50	20,137	0,9983	
Test4	231,42	50,00	20,081	0,9996	
Test5	231,47	50,50	20,080	0,9993	
<p>Note:</p> <p>Test method refer clause D.3.1 of EN 50438:2013.</p> <p>During the tests the interface protection was disabled.</p> <p>Operation at reduced power is allowed during test 1, equal to the maximum power that can be supplied on reaching the maximum output current limit ($P \geq 0,85 S_n$).</p> <p>During the sequence of test 3, automatic adjustment to reduce power in the case of over-frequency was disabled.</p> <p>The tests had been performed on the HYD 20KTL-3PH is valid for the HYD 15KTL-3PH, HYD 10KTL-3PH, HYD 8KTL-3PH, HYD 6KTL-3PH and HYD 5KTL-3PH since it is similar in hardware and just power derated by software.</p> <p>The test results refer to the test report "PV200302N015-6" issued by Bureau Veritas Shenzhen Co., Ltd. Dongguan Branch, dated on 2020.08.21.</p>					

4.4.3 Minimal requirement for active power delivery at under-frequency

P

Graph of frequency a) to b) to c) to d) to e):

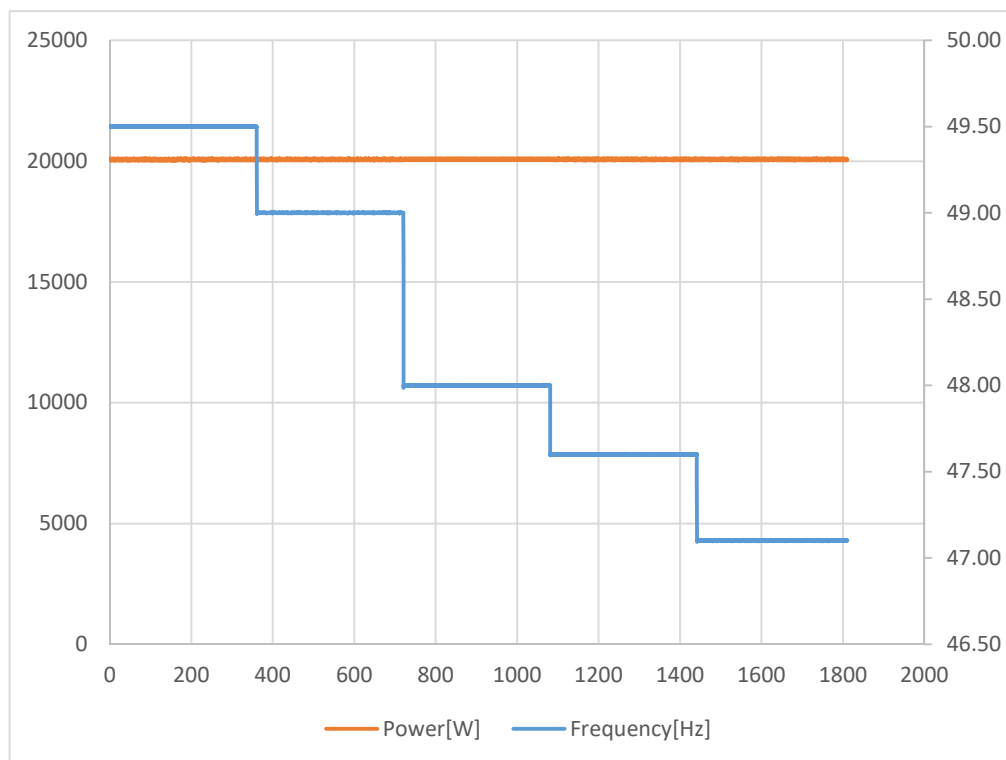

Test result:

	Switch to:				
5-min mean value (each)	a) 49,50 Hz	b) 49,00 Hz	c) 48,00 Hz	d) 47,60 Hz	e) 47,10 Hz
Frequency [Hz]:	49,50	49,00	48,00	47,60	47,10
Active power [kW]:	20,071	20,074	20,074	20,074	20,072
$\Delta P/P_n$ [%] :	100,36	100,37	100,37	100,37	100,36

Assessment criterion:

Test method refer clause A.7.3.2 of G99/1-4

The frequency should then be set to 49,5 Hz for 5 minutes. The output should remain at 100% of registered Capacity.

The frequency should then be set to 49,0 Hz and once the output has stabilised, held at this frequency for 5 minutes. The Active Power output must not be below 99% of registered Capacity.

The frequency should then be set to 48,0 Hz and once the output has stabilised, held at this frequency for 5 minutes. The Active Power output must not be below 97% of registered Capacity.

The frequency should then be set to 47,6 Hz and once the output has stabilised, held at this frequency for 5 minutes. The Active Power output must not be below 96.2% of registered Capacity.

The frequency should then be set to 47,1 Hz and held at this frequency for 20s. The Active Power output must not be below 95,0% of registered Capacity and the Synchronous Power Generating Module must not trip in less than the 20s of the test.

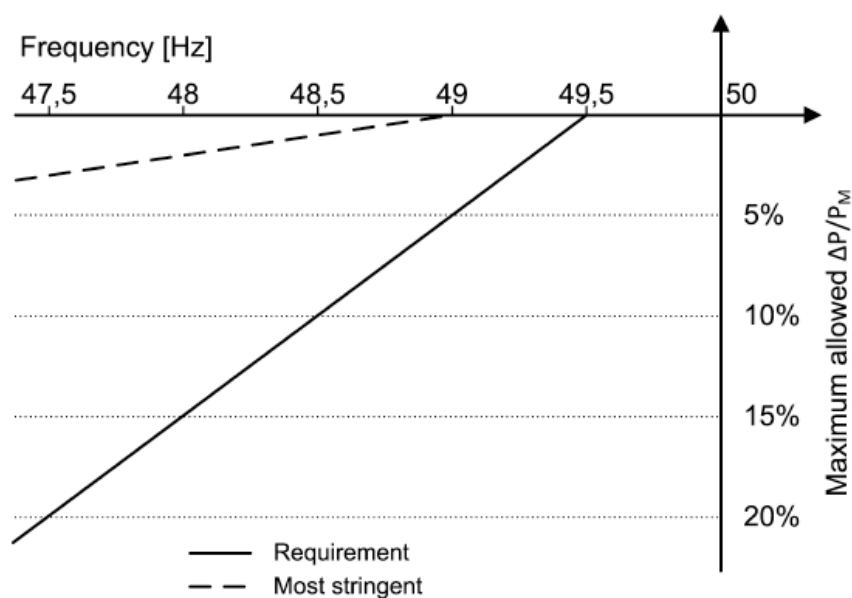

Maximum allowable power reduction in case of under-frequency

Note:

The tests had been performed on the HYD 20KTL-3PH is valid for the HYD 15KTL-3PH, HYD 10KTL-3PH, HYD 8KTL-3PH, HYD 6KTL-3PH and HYD 5KTL-3PH since it is similar in hardware and just power derated by software.

The test results refer to the test report "PV200302N015-6" issued by Bureau Veritas Shenzhen Co., Ltd. Dongguan Branch, dated on 2020.08.21.

EN 50549-1:2019: Immunity to disturbances

Clause	Test requirement	Test procedure according standard	Result
4.5.2	Rate of change of frequency (RoCoF) immunity	G99/1-4:2019, clause A.7.1.2.6	P
4.5.3	Low voltage ride through (LVRT)	VDE V 0124-100:2019-02 (Draft), clause 5.8.3.	P
4.5.4	High voltage ride through (HVRT)	VDE V 0124-100:2019-02 (Draft), clause 5.8.3.	P
4.7.4	Zero current mode for converter connected generating plants	VDE V 0124-100:2019-02 (Draft), clause 5.8.3.	P

4.5.2 Rate of change of frequency (ROCOF) immunity(defual settings)				P
	Start Frequency	Change	End Frequency	Confirm no trip
Positive Frequency drift	49Hz	+2Hz/sec	51Hz	No trip
Negative Frequency drift	51Hz	-2Hz/sec	49Hz	No trip

Note:

Test method refer clause A.7.1.2.6 of G99/1-4:2019.

Hold for 10 s

Manufacturers considering new designs should allow for the RoCoF where stability is required to be increased to, up to 2Hz per second, as proposed in the new European network codes, which are expected to come into force over the period 2014/2015. Under these conditions RoCoF will cease to be an effective loss of mains protection and is unlikely to be permitted in future revisions of this document.

For the step change test the SSEG should be operated with a measureable output at the start frequency and then a vector shift should be applied by extending or reducing the time of a single cycle with subsequent cycles returning to the start frequency. The start frequency should then be maintained for a period of at least 10 seconds to complete the test. The SSEG should not trip during this test.

For frequency drift tests the SSEG should be operated with a measureable output at the start frequency and then the frequency changed in a ramp function at 0,95Hz per second to the end frequency. On reaching the end frequency it should be maintained for a period of at least 10 seconds. The SSEG should not trip during this test.

The tests had been performed on the HYD 20KTL-3PH is valid for the HYD 15KTL-3PH, HYD 10KTL-3PH, HYD 8KTL-3PH, HYD 6KTL-3PH and HYD 5KTL-3PH since it is similar in hardware and just power derated by software.

The test results refer to the test report "PV200302N015-6" issued by Bureau Veritas Shenzhen Co., Ltd. Dongguan Branch, dated on 2020.08.21.

<p>4.5.3 Low voltage ride through (LVRT) 4.5.4 High voltage ride through (HVRT) 4.7.4 Zero current mode for converter connected generating plants</p>	P
---	---

General:

If the voltage on the generator terminals falls below $<0.8 U_n$ and if the generator terminals exceed the voltage of $> 1.15 U_n$ (start of fault), generator must pass through voltage dips without any current being drawn into the grid Network operator (limited dynamic network support).

This requirement is met if, for a voltage dip below $0.8 U_n$ or at a voltage increase above $1.15 U_n$, the injected current of the generating unit (s) and / or the memory 60 ms after occurrence of this voltage dip in any outer conductor 20% of the rated current I_r and does not exceed $> 10\% I_r$ after 100 ms.

After the voltage returned to continuous operating voltage range of $-15\% U_n$ to $+10\% U_n$, 90 % of pre fault power or available power whichever is the smallest shall be resumed as fast as possible, but at the latest within 1 s unless the DSO and the responsible party requires another value.

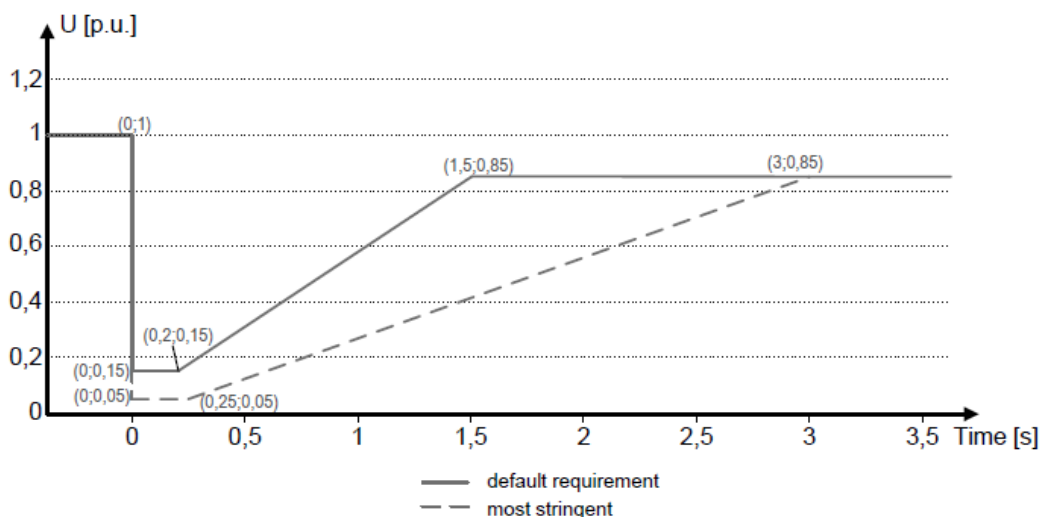

Figure 6 — Low voltage ride through capability for non-synchronous generating technology

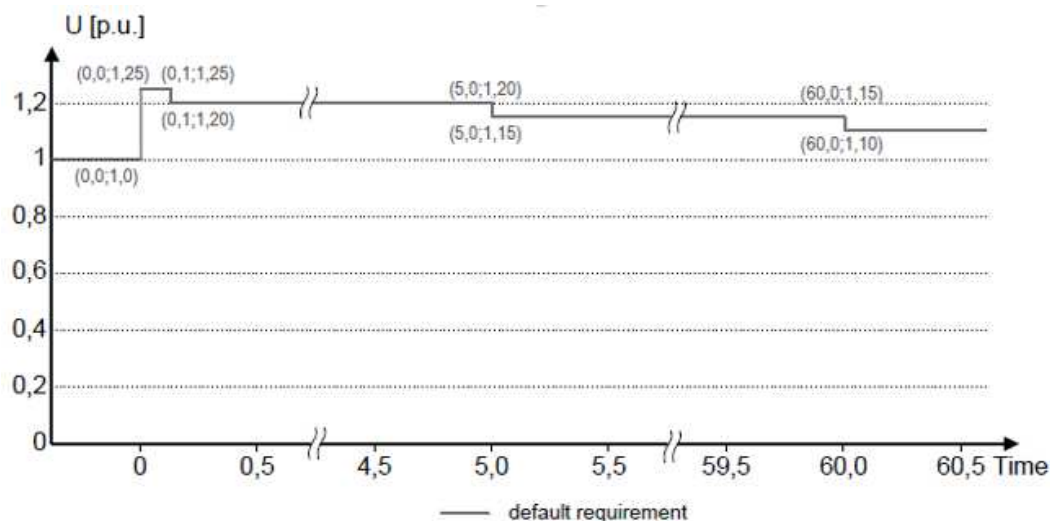

Figure 8 — Over-voltage ride through capability

Test	Drop depth requirement [p.u. U_n]	Symmetry	Fault duration [ms]	Output power level		k-factor	Test no.
				P set point (P_{rE} / p.u.)	Q set point (Q / p.u.)		
1.A.1	0,03	Symmetrical	250	1,0	0,00	0	1.A.1
1.A.2				0,2			1.A.2
1.D.1		Asymmetrical		1,0			1.D.1
1.D.2				0,2			1.D.2
1.B.1		Single phase*		1,0			1.B.1
1.B.2				0,2			1.B.2
2.A.1	0,31	Symmetrical	1300	1,0	0,00	0	2.A.1
2.A.2				0,2			2.A.2
2.D.1		Asymmetrical		1,0			2.D.1
2.D.2				0,2			2.D.2
2.B.1		Single phase*		1,0			2.B.1
2.B.2				0,2			2.B.2
3.A.1	0,82	Symmetrical	3000	1,0	0,00	0	3.A.1
3.A.2				0,2			3.A.2
3.D.1		Asymmetrical		1,0			3.D.1
3.D.2				0,2			3.D.2
3.B.1		Single phase*		1,0			3.B.1
3.B.2				0,2			3.B.2
OV1	1,25	Symmetrical	100	1,0	0,00	0	OV1
OV2	1,20		5000	1,0			OV2
OV3	1,15		60000	1,0			OV3

Note:

For every kind of voltage dip a test without load has to be performed in order to prove that the test condition was fulfilled. The voltage has to drop to AT LEAST the defined depth level. An exception can be considered in case no current is supplied during dips.

* **Single phase = "choose Typ 7 at BV-Lab Studio" \triangleq LVRT Typ B**

The tests had been performed on the HYD 20KTL-3PH is valid for the HYD 15KTL-3PH, HYD 10KTL-3PH, HYD 8KTL-3PH, HYD 6KTL-3PH and HYD 5KTL-3PH since it is similar in hardware and just power derated by software.

The test results refer to the test report "PV200302N015-6" issued by Bureau Veritas Shenzhen Co., Ltd. Dongguan Branch, dated on 2020.08.21.

No Load				
Test result:				
List of tests	Residual amplitude of phase-to-phase voltage [p.u. U _n]	Duration limit [ms]	Duration [ms]	result
P _E max in %	100% ±5%			
1.A.1- Symmetrical	0,03	250 ± 20	259	--
1.D.1- Asymmetrical	0,03	250 ± 20	259	--
1.B.1- Single phase	0,03	250 ± 20	258	--
2.A.1- Symmetrical	0,31	1300 ± 20	1316	--
2.D.1- Asymmetrical	0,31	1300 ± 20	1309	--
2.B.1- Single phase	0,31	1300 ± 20	1312	--
3.A.1- Symmetrical	0,82	3000 ± 20	3010	--
3.D.1- Asymmetrical	0,82	3000 ± 20	3010	--
3.B.1- Single phase	0,82	3000 ± 20	3010	--
OV1- Symmetrical	1,25	100 ± 20	119	--
OV2-Symmetrical	1,20	5000 ± 20	5015	--
OV3-Symmetrical	1,15	60000± 20	60019	--

1.A.1- Symmetrical

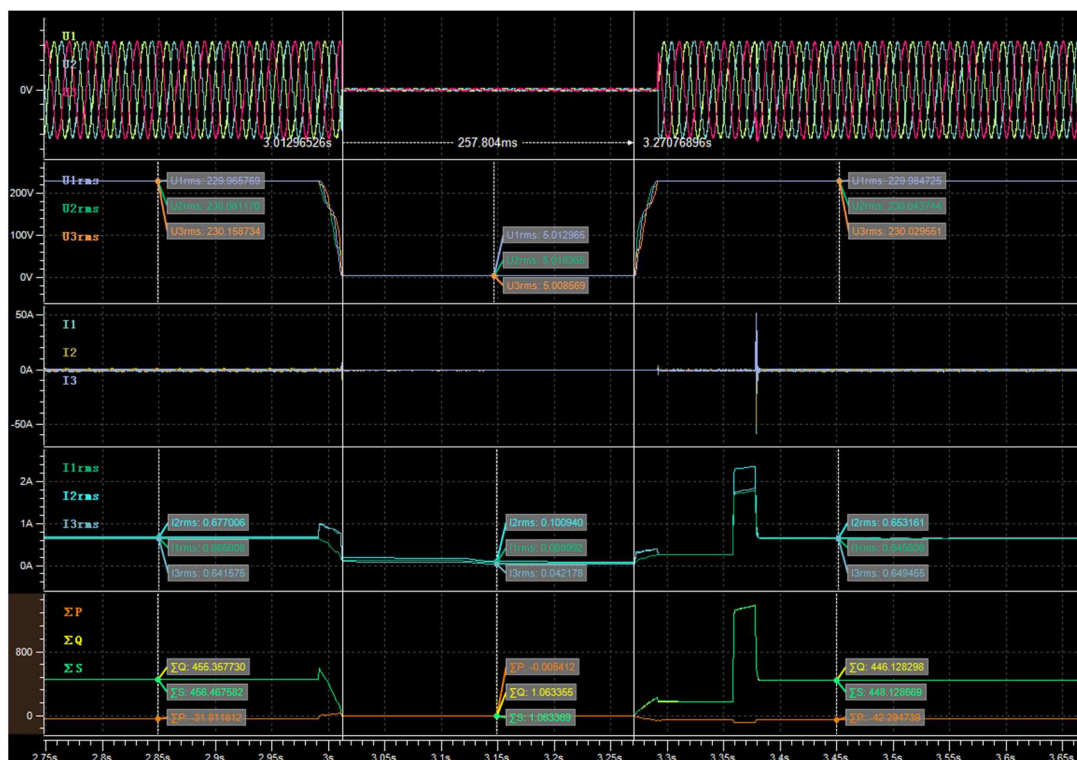

1.D.1- Asymmetrical

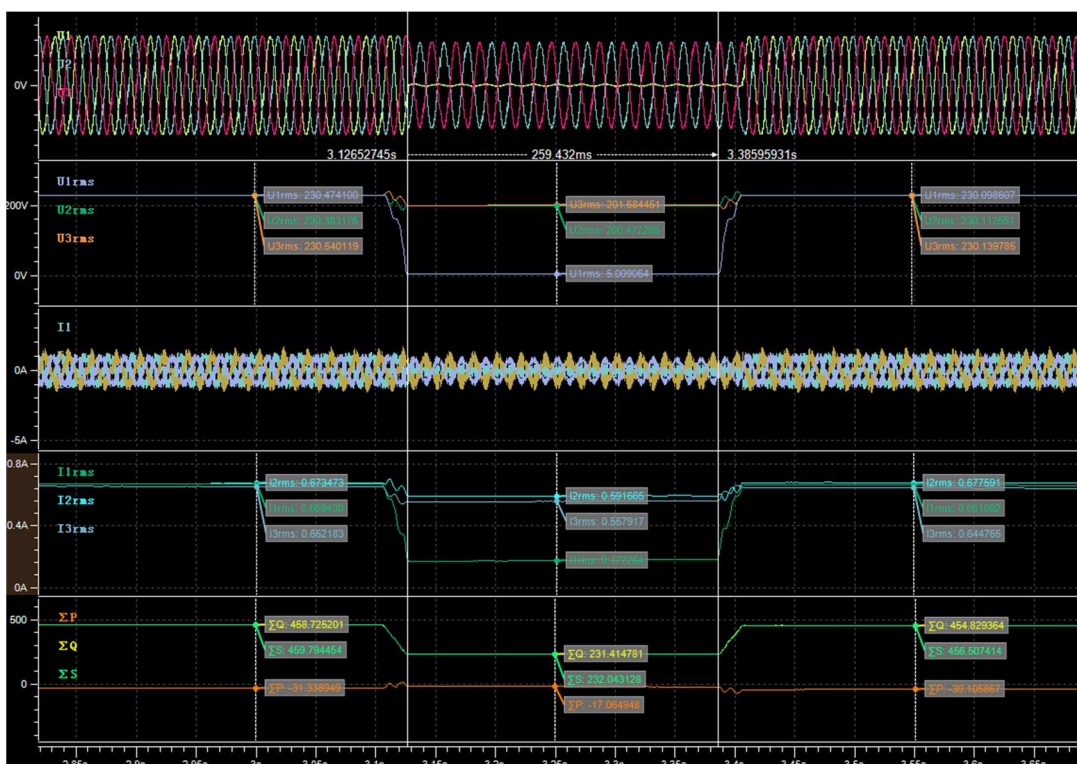

1.B.1- Single phase

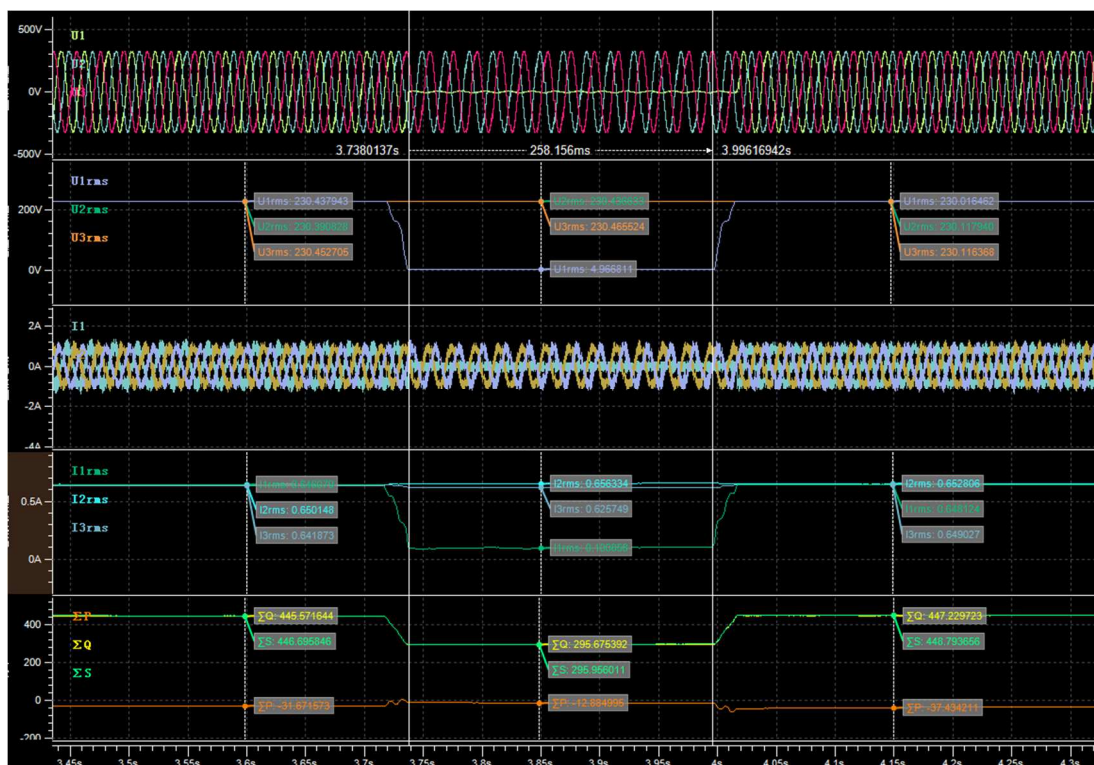

2.A.1- Symmetrical

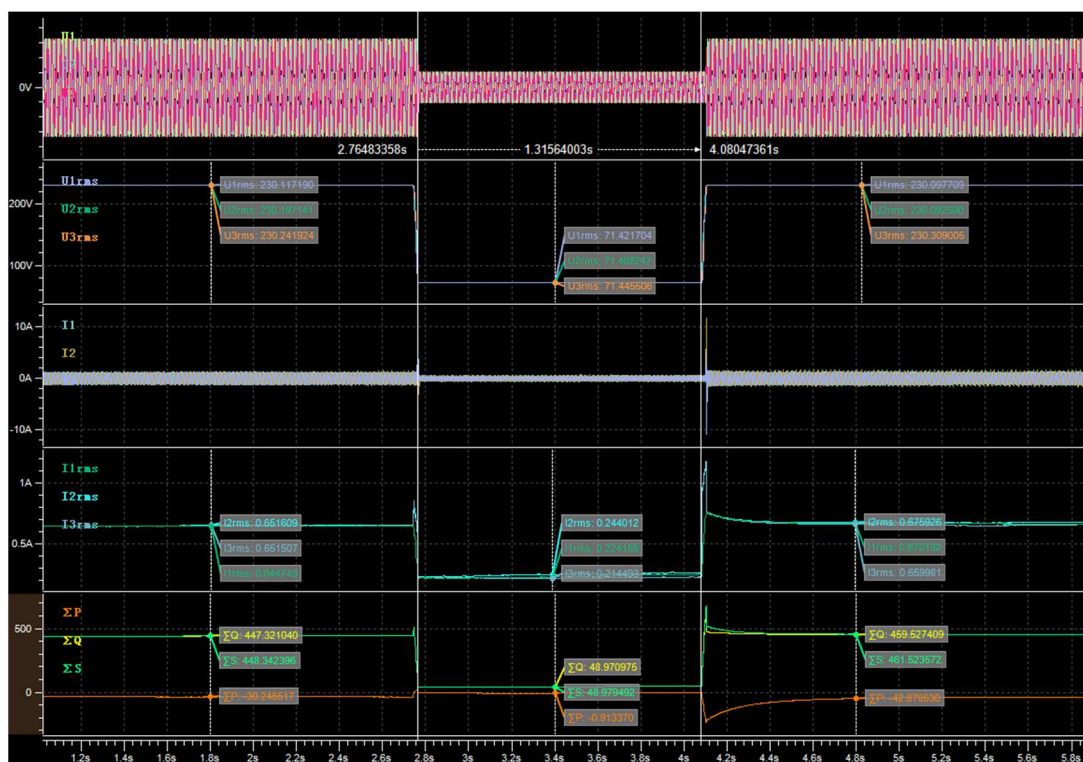

2.D.1- Asymmetrical

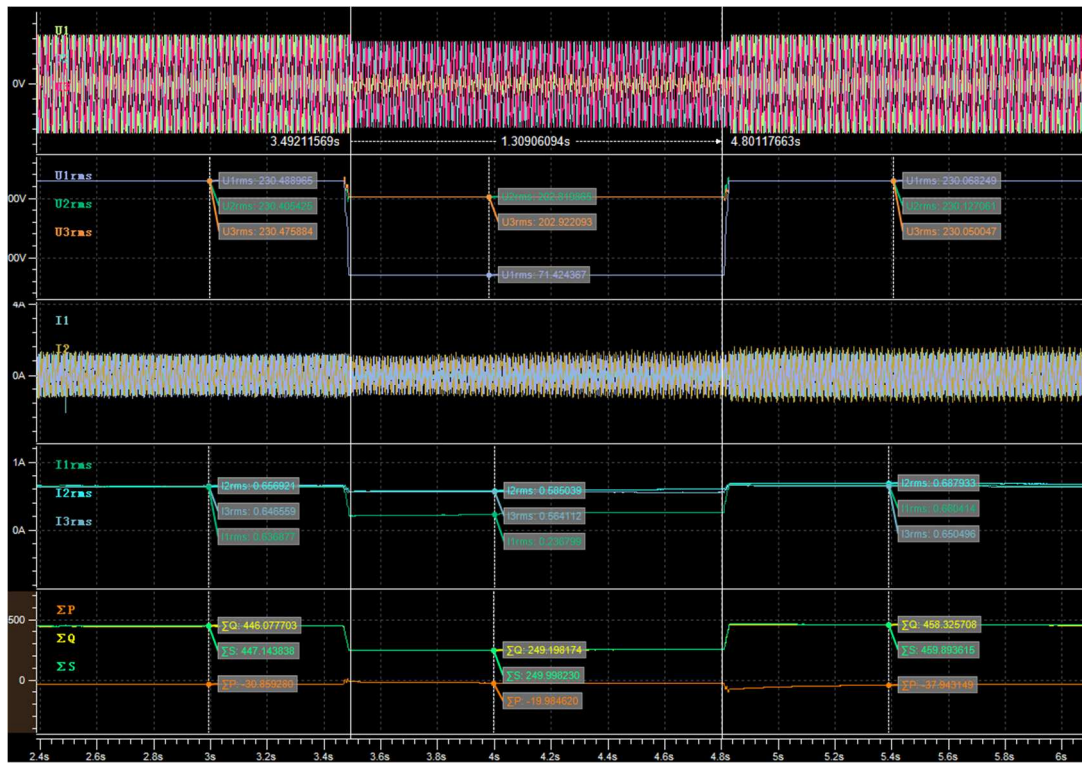

2.B.1- Single phase

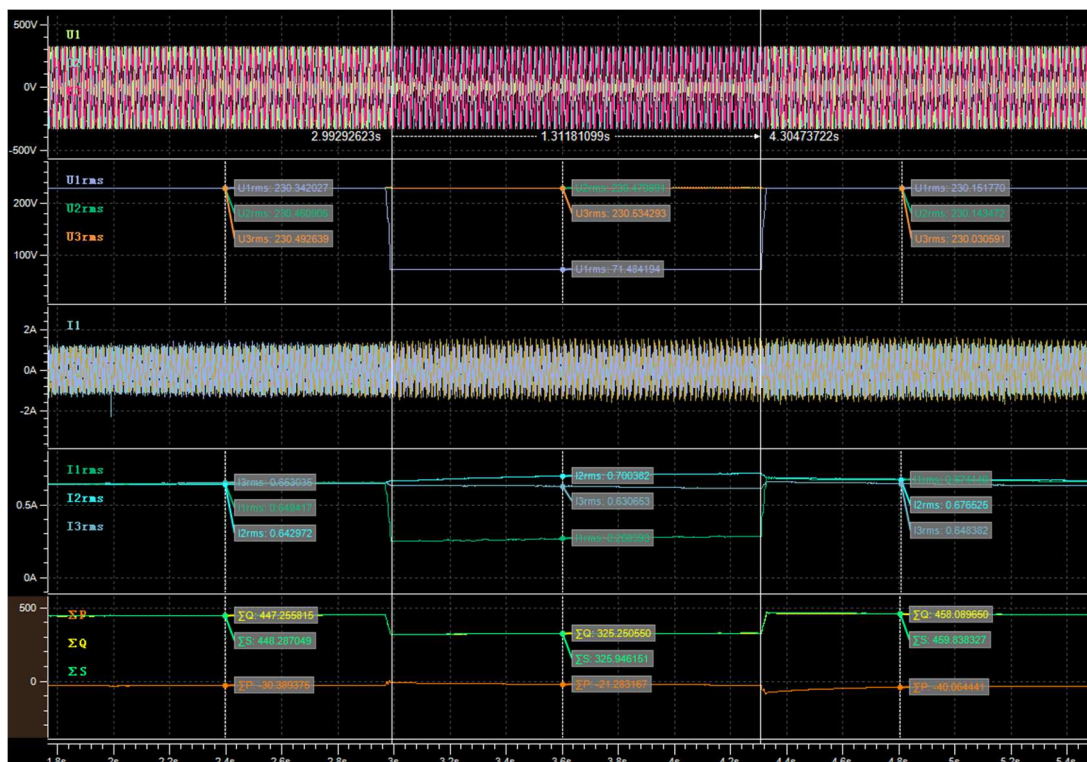

3.A.1- Symmetrical

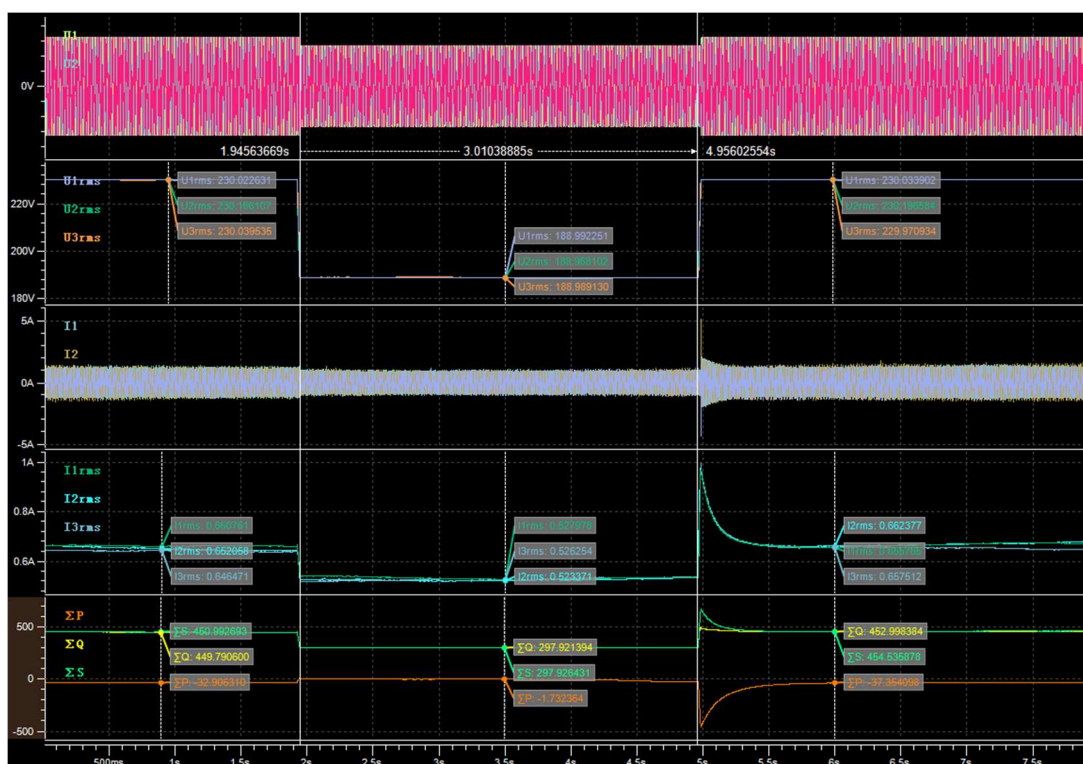

3.D.1- Asymmetrical

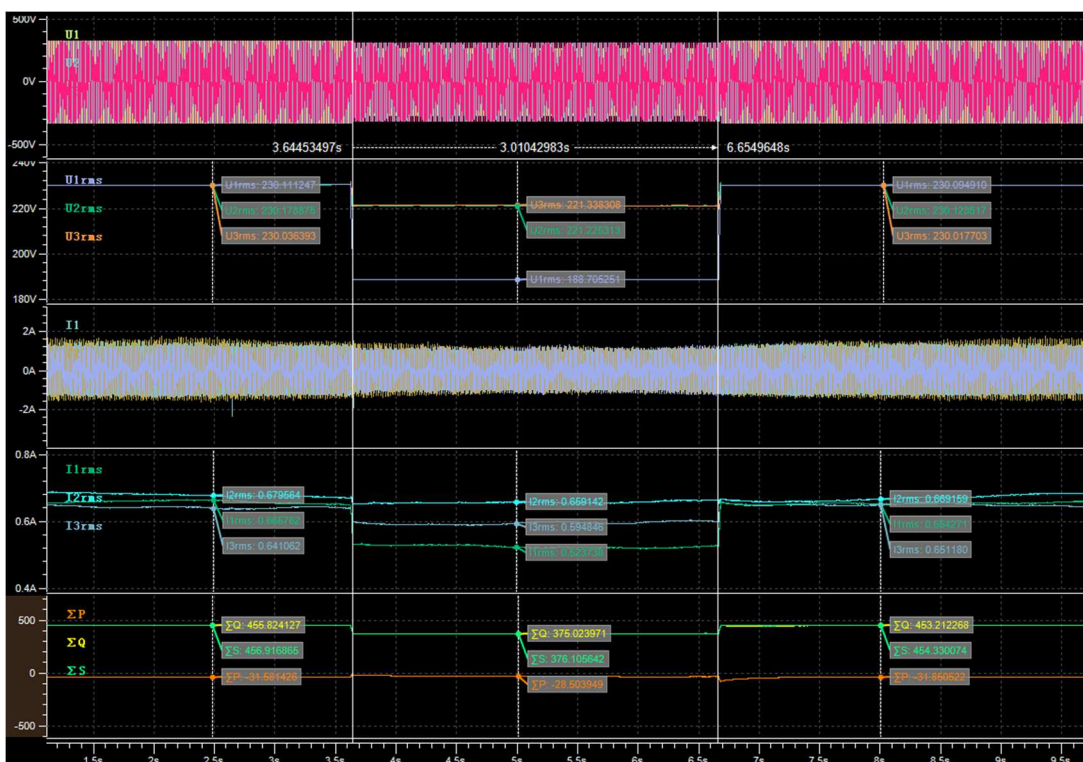

3.B.1- Single phase

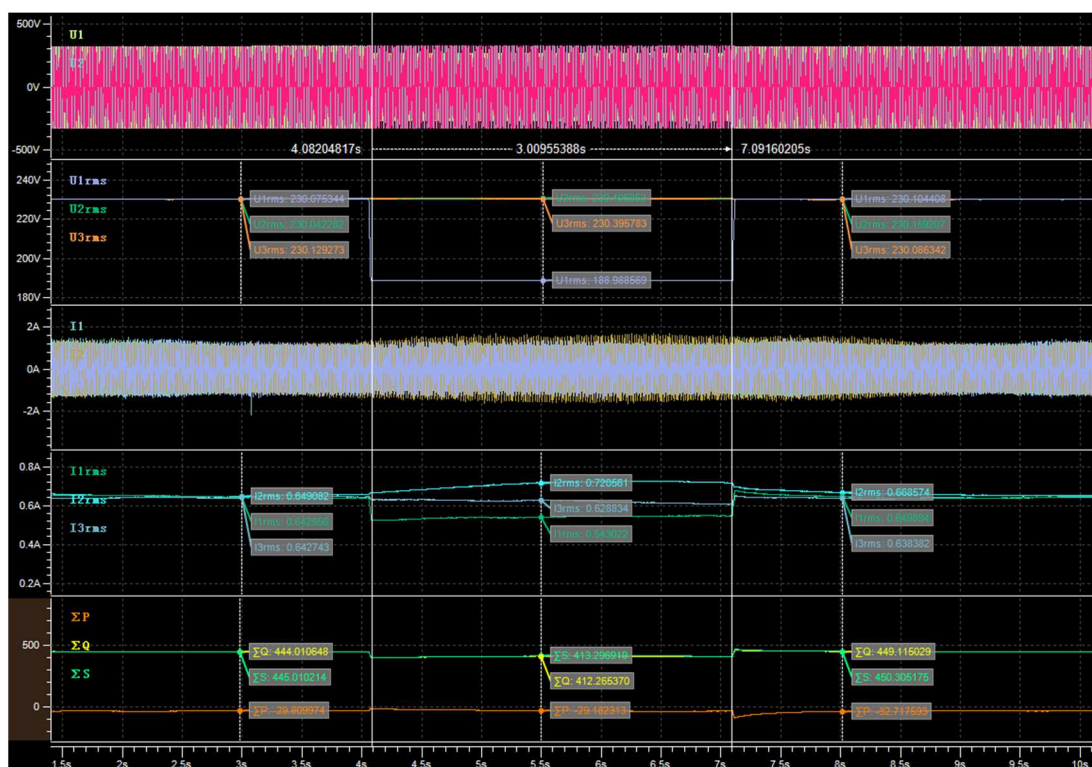

OV1- Symmetrical

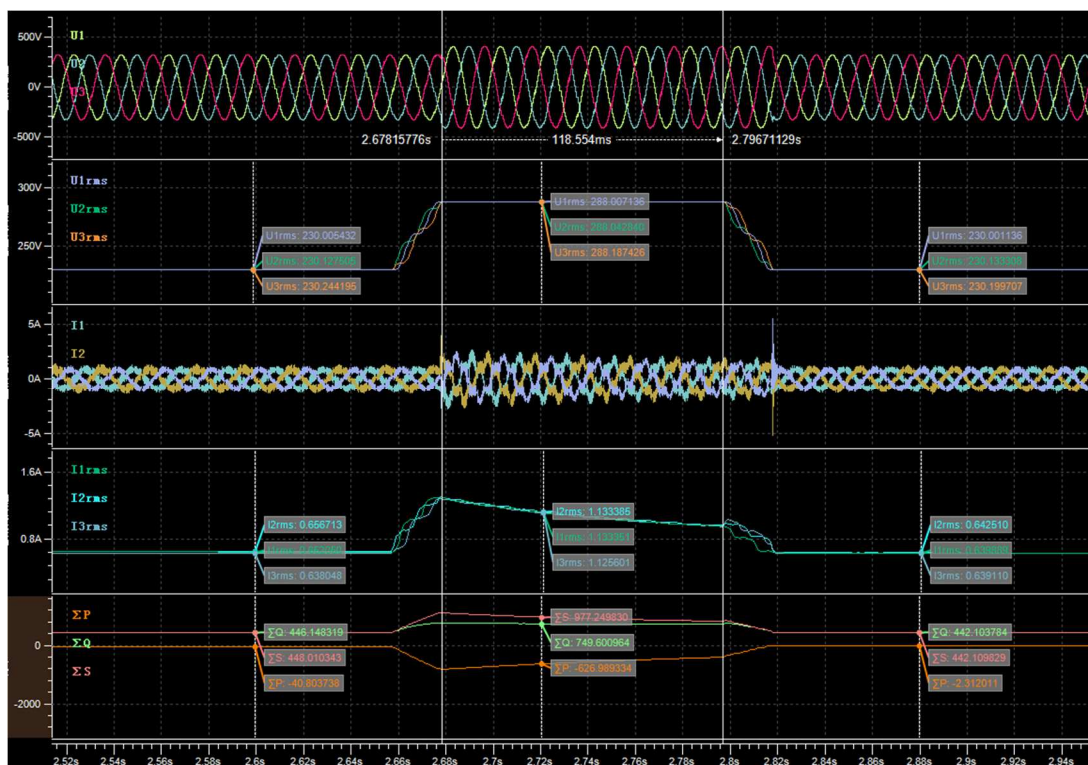

OV2- Symmetrical

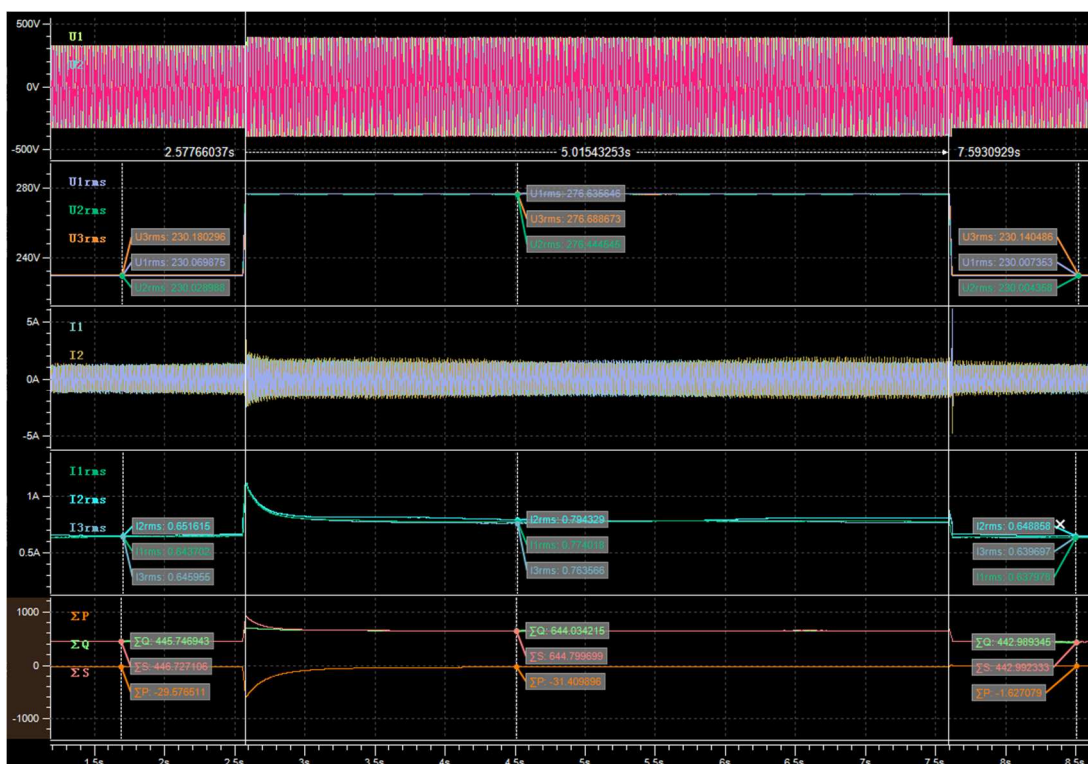

OV3-Symmetrical

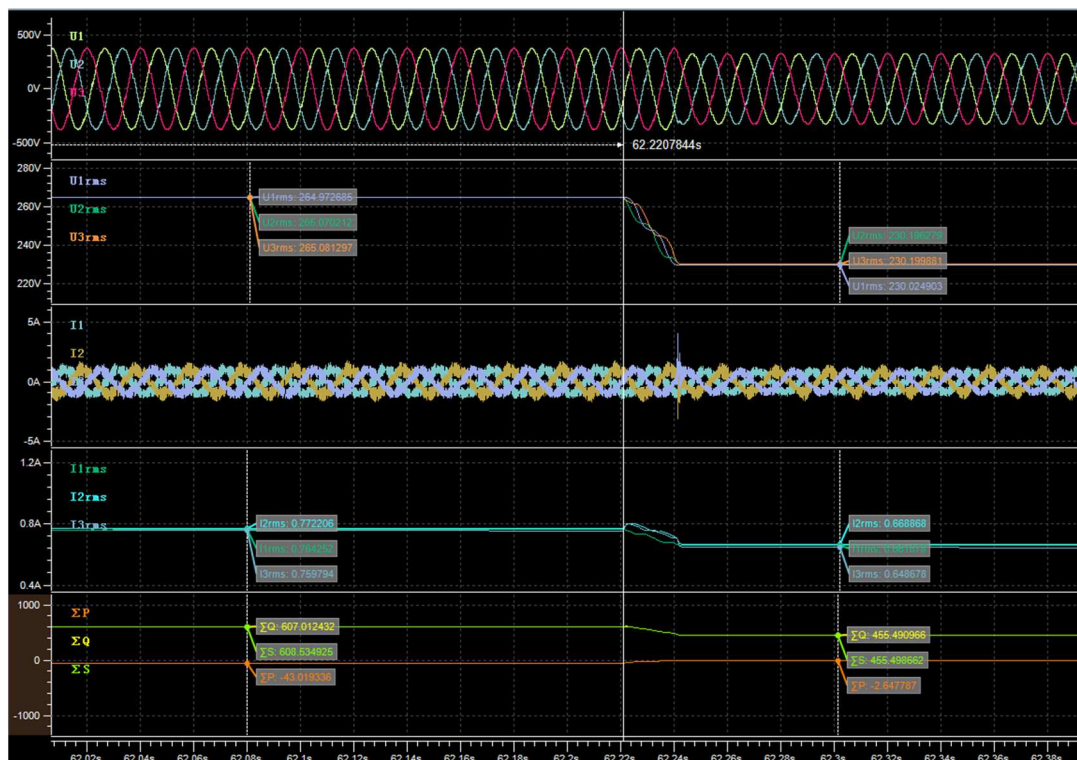
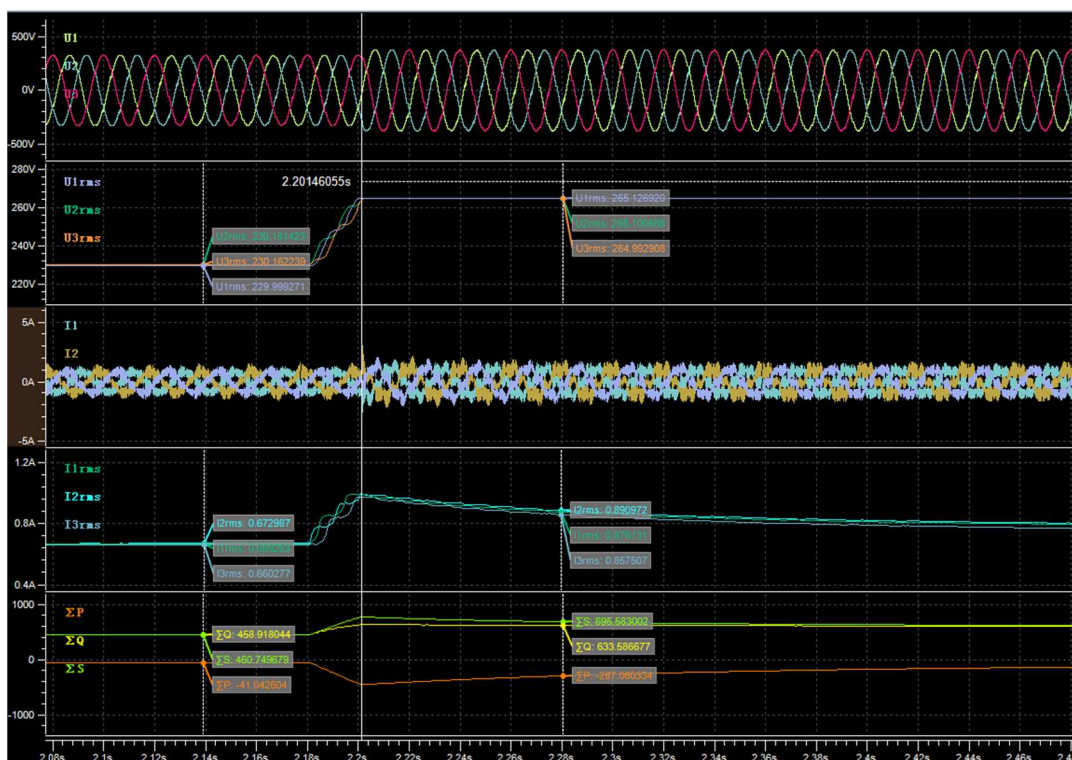

Graph of FRT test one				
Test result:				
List of tests	Residual amplitude of phase-to-phase voltage [p.u. U_n]	Duration limit [ms]	Duration [ms]	Result
$P_{E_{max}}$ in %	100% \pm 5%			
1.A.1- Symmetrical	0,03	250 \pm 20	259	Pass
1.D.1- Asymmetrical	0,03	250 \pm 20	260	Pass
1.B.1- Single phase	0,03	250 \pm 20	257	Pass
2.A.1- Symmetrical	0,31	1300 \pm 20	1310	Pass
2.D.1- Asymmetrical	0,31	1300 \pm 20	1310	Pass
2.B.1- Single phase	0,31	1300 \pm 20	1310	Pass
3.A.1- Symmetrical	0,82	3000 \pm 20	3008	Pass
3.D.1- Asymmetrical	0,82	3000 \pm 20	3011	Pass
3.B.1- Single phase	0,82	3000 \pm 20	3010	Pass
$P_{E_{max}}$ in %	20% \pm 5%			
1.A.2- Symmetrical	0,03	250 \pm 20	257	Pass
1.D.2- Asymmetrical	0,03	250 \pm 20	258	Pass
1.B.2- Single phase	0,03	250 \pm 20	259	Pass
2.A.2- Symmetrical	0,31	1300 \pm 20	1310	Pass
2.D.2- Asymmetrical	0,31	1300 \pm 20	1310	Pass
2.B.2- Single phase	0,31	1300 \pm 20	1310	Pass
3.A.2- Symmetrical	0,82	3000 \pm 20	3011	Pass
3.D.2- Asymmetrical	0,82	3000 \pm 20	3011	Pass
3.B.2- Single phase	0,82	3000 \pm 20	3010	Pass
$P_{E_{max}}$ in %	100% \pm 5%			
OV1- Symmetrical	1,25	100 \pm 20	100	Pass
OV2- Symmetrical	1,20	5000 \pm 20	5007	Pass
OV3- Symmetrical	1,15	60000 \pm 20	60011	Pass
Test conditions:				
Voltage simulator fall and rise time: < 20ms				
Used sample rate: 10 kHz				
Note:				
The test method refer to VDE V 0124-100:2019-02 (Draft), clause 5.8.3.				

Test 1.A.1-Symmetrical fault (U/U_{nom} = 0,03); P = 100% ±5% P_n

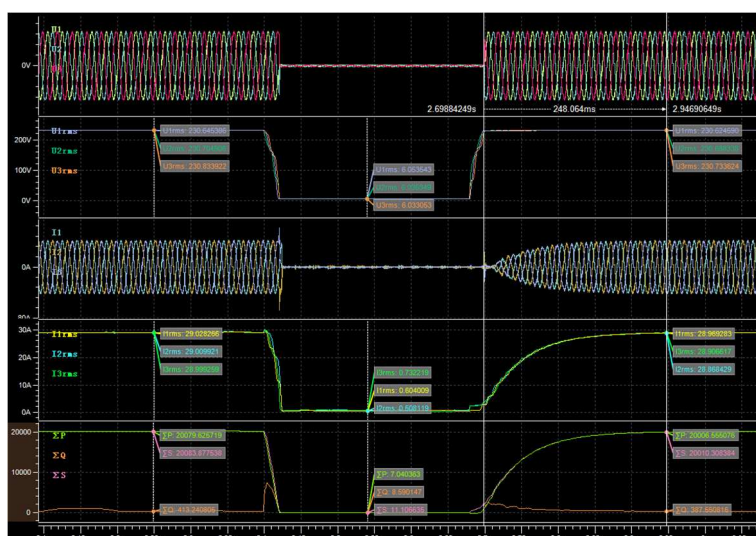
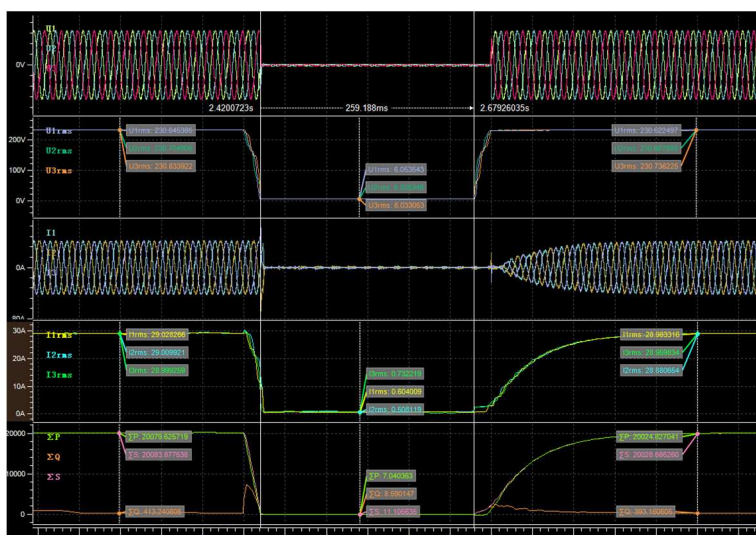
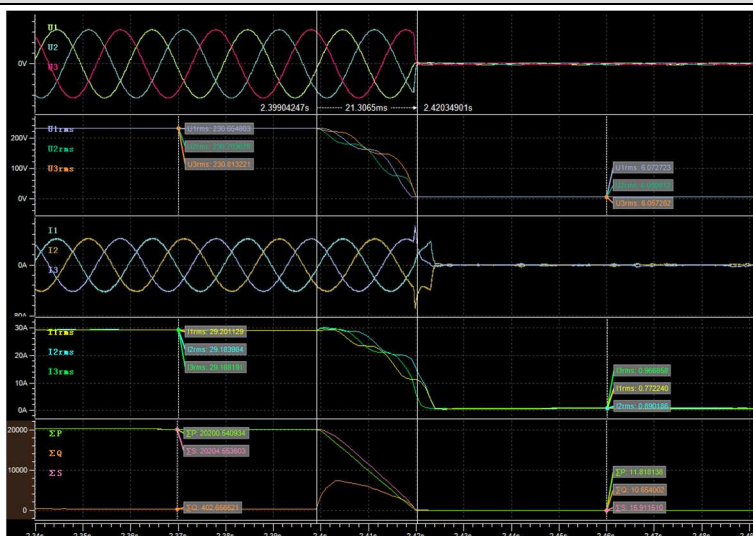

Test 1.D.1-Asymmetrical fault ($U/U_{nom} = 0,03$); $P = 100\% \pm 5\% P_n$

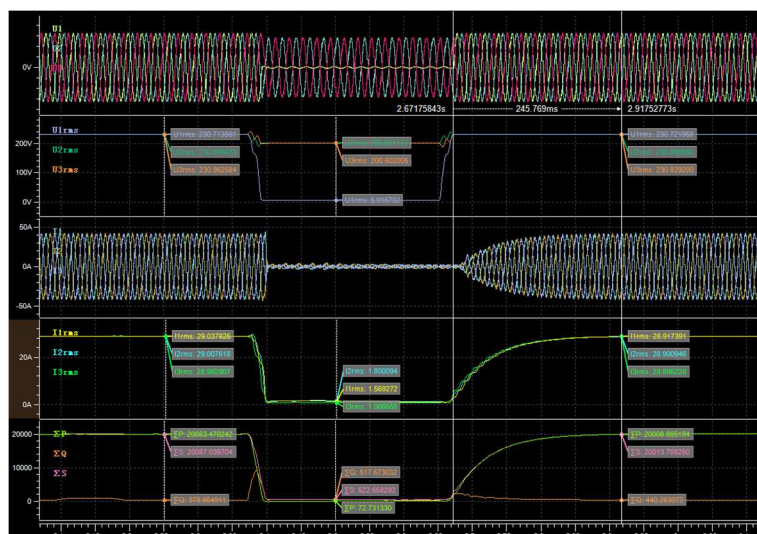
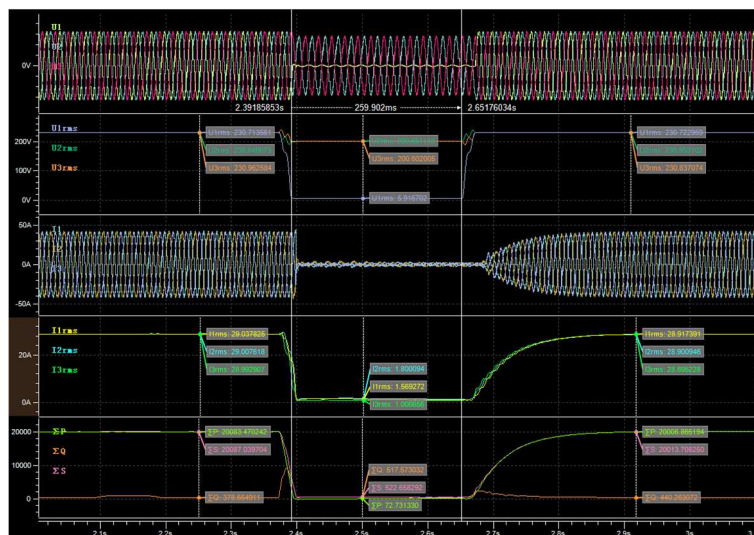
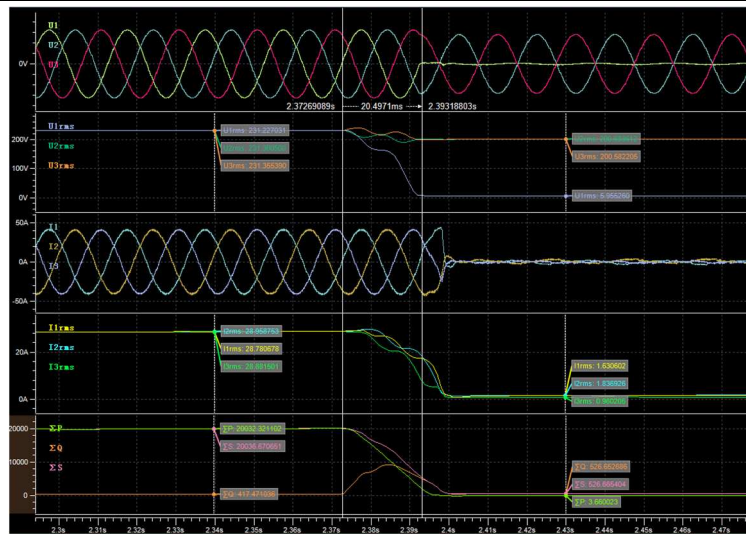

Test 1.B.1-Single phase fault (U/U_{nom} = 0,03); P = 100% ±5% P_n

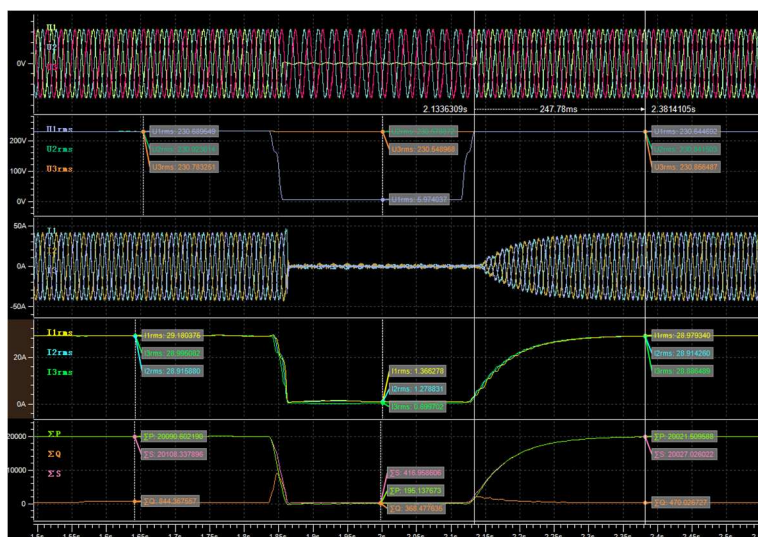
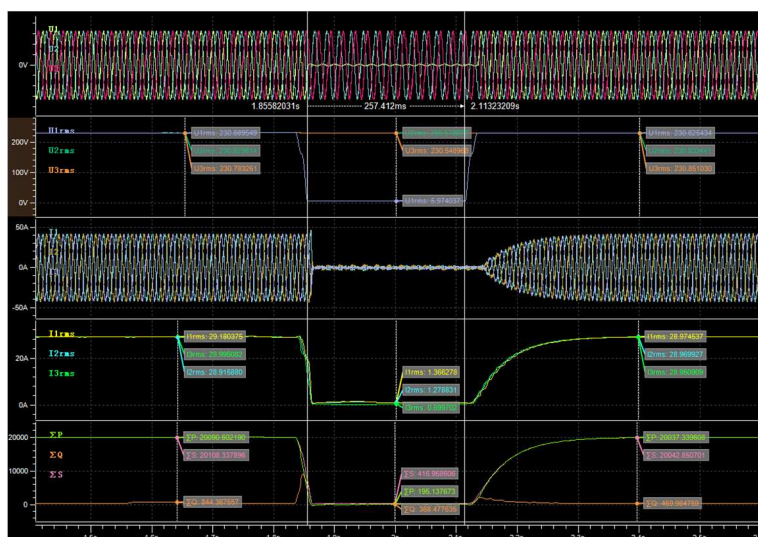
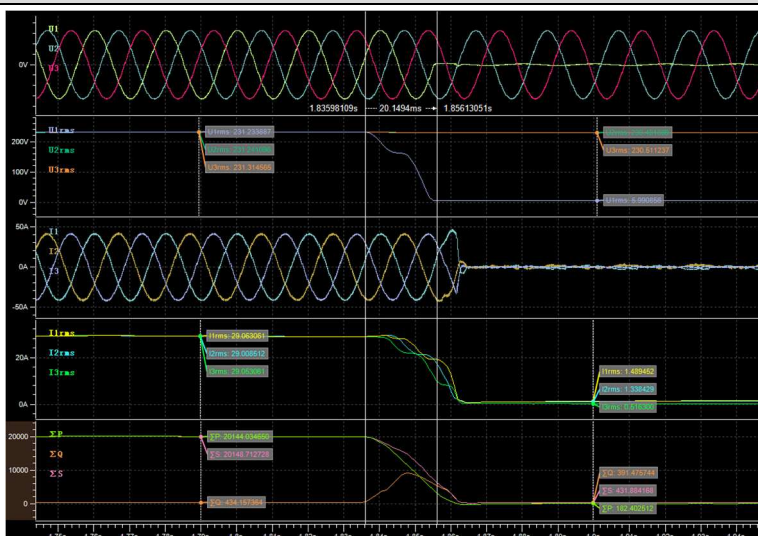

Test 2.A.1-Symmetrical fault (U/U_{nom} = 0,31); P = 100% ±5% P_n

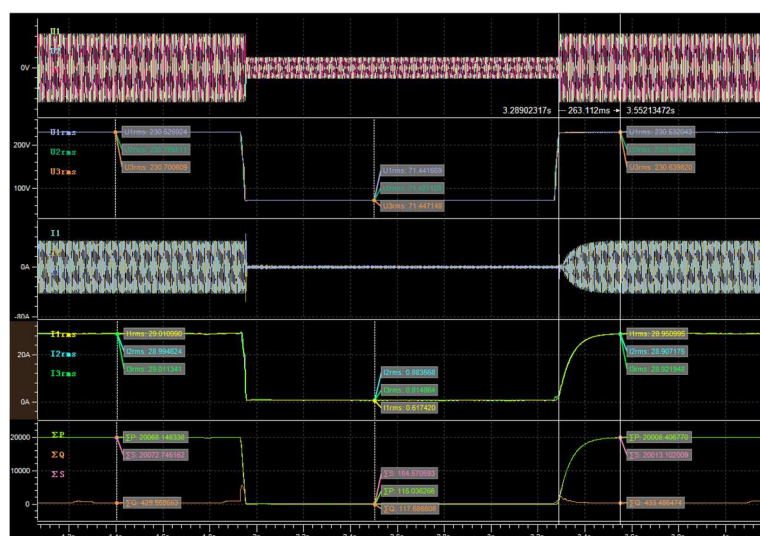
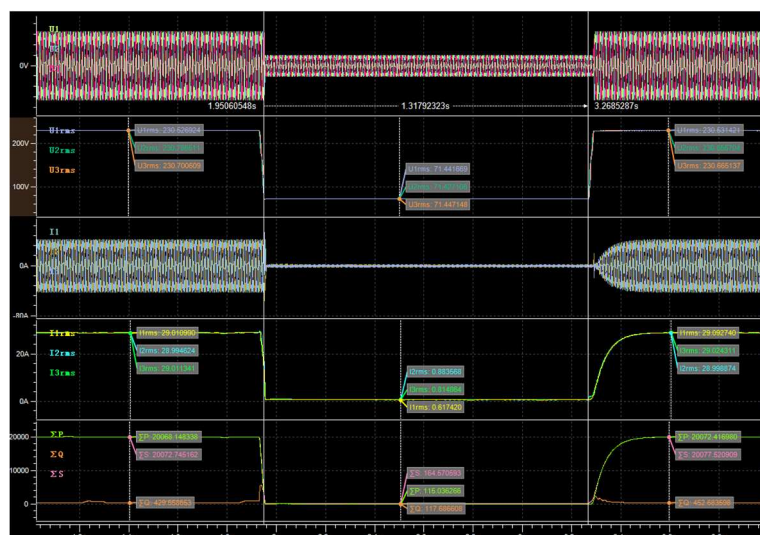
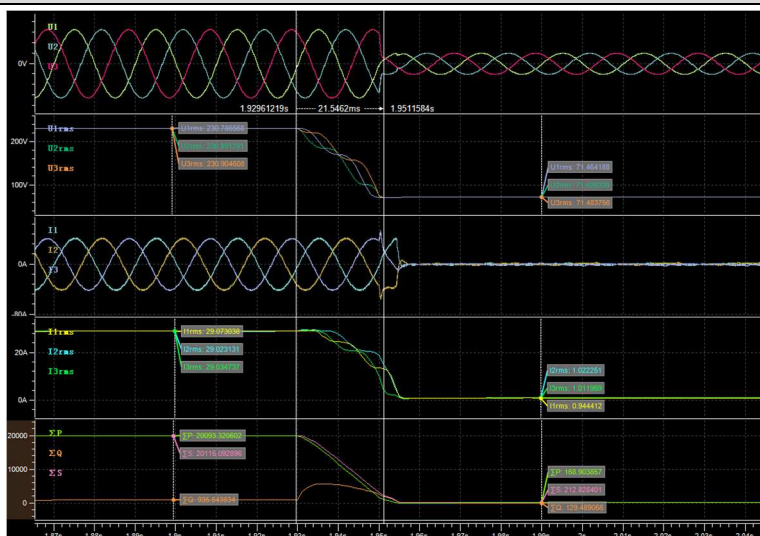

Test 2.D.1- Asymmetrical fault ($U/U_{nom} = 0,31$); $P = 100\% \pm 5\% P_n$

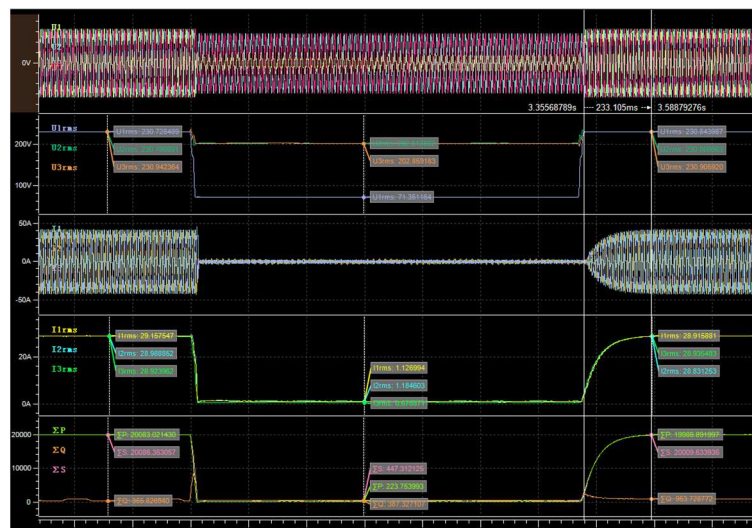
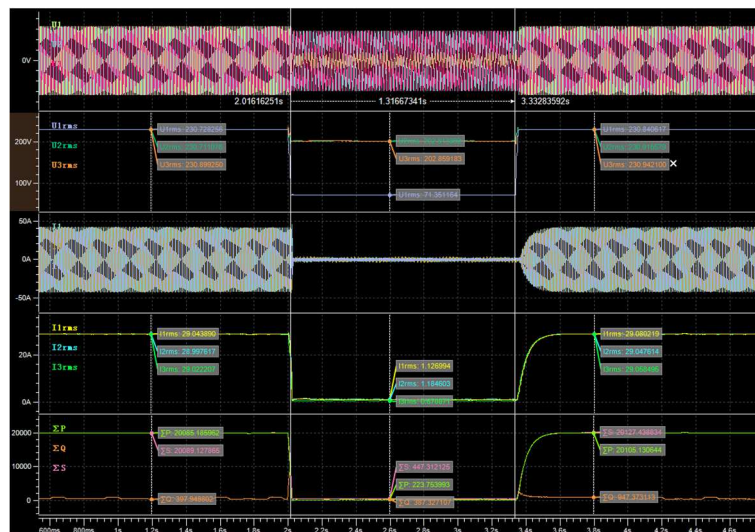
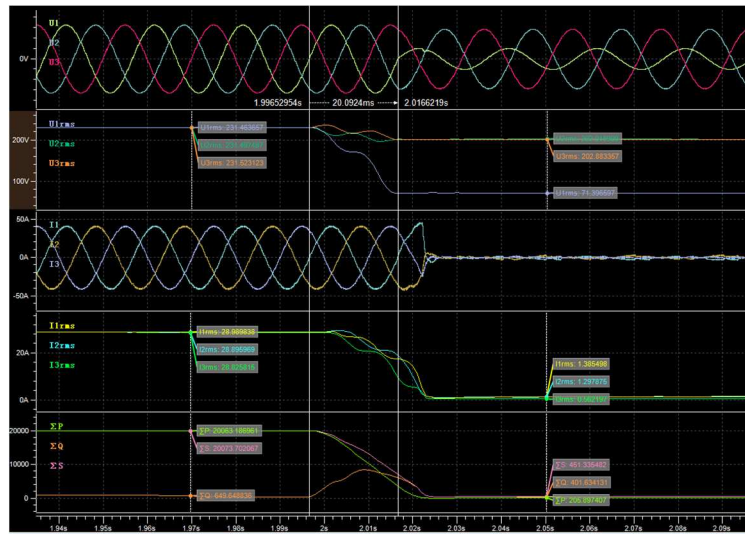

Test 2.B.1-Single phase fault (U/U_{nom} = 0,31); P = 100% ±5% P_n

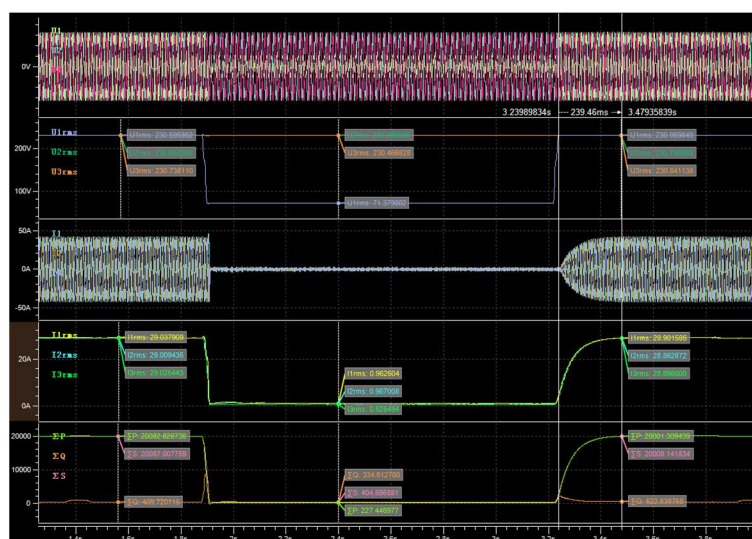
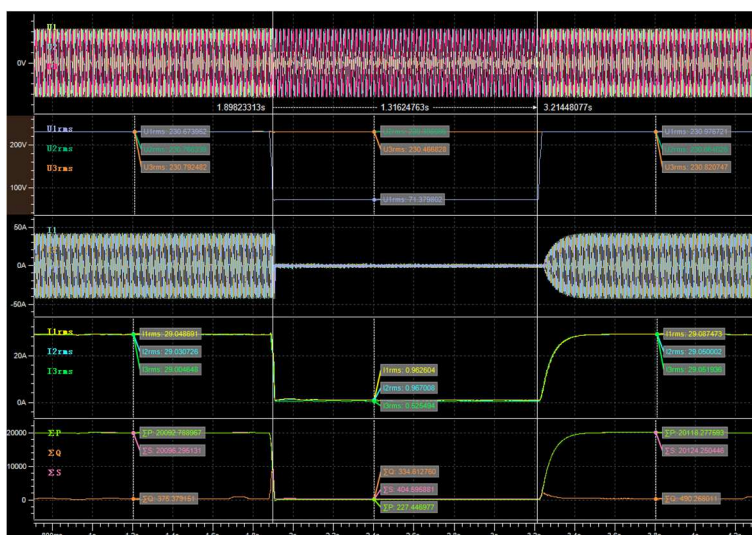
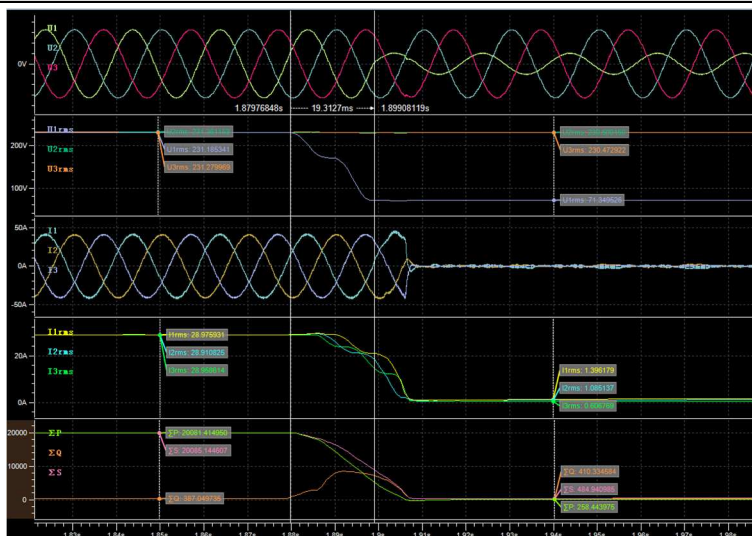

Test 3.A.1-Symmetrical fault (U/U_{nom} = 0,82); P = 100% ±5% P_n

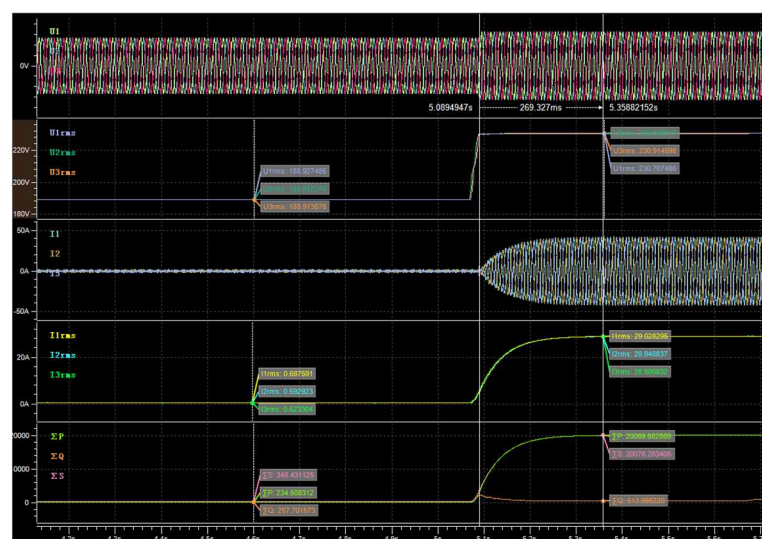
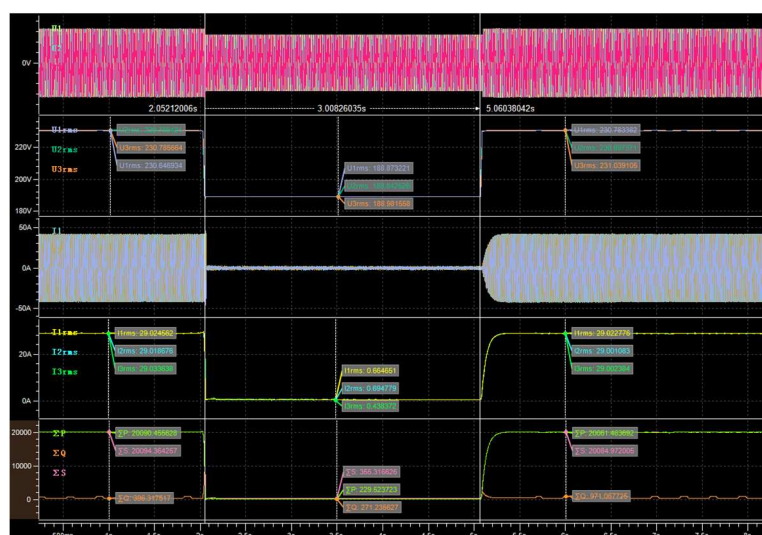
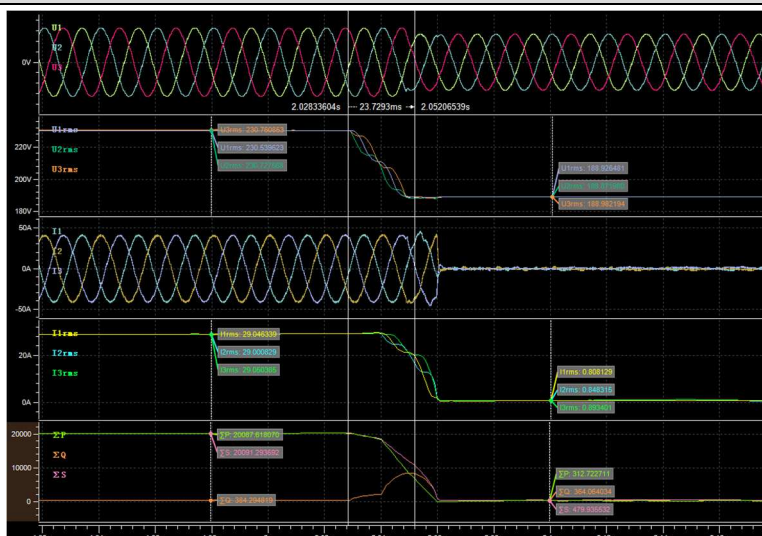

Test 3.D.1-Asymmetrical fault (U/U_{nom} = 0,82); P = 100% ±5% P_n

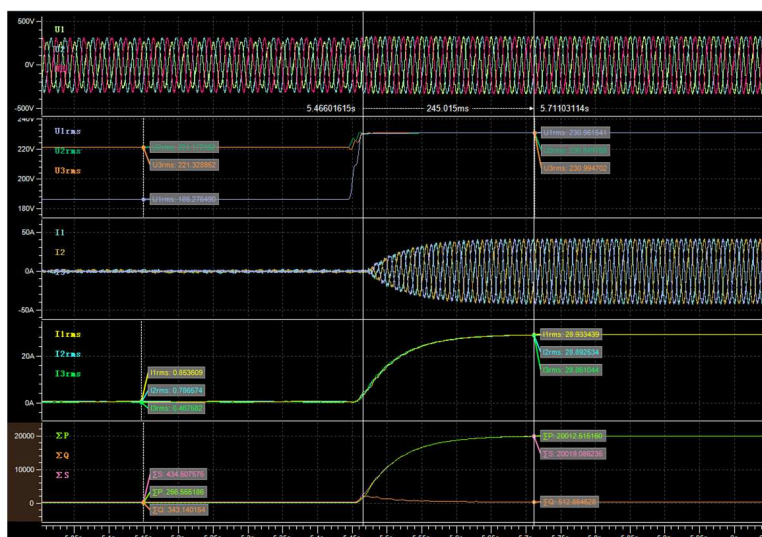
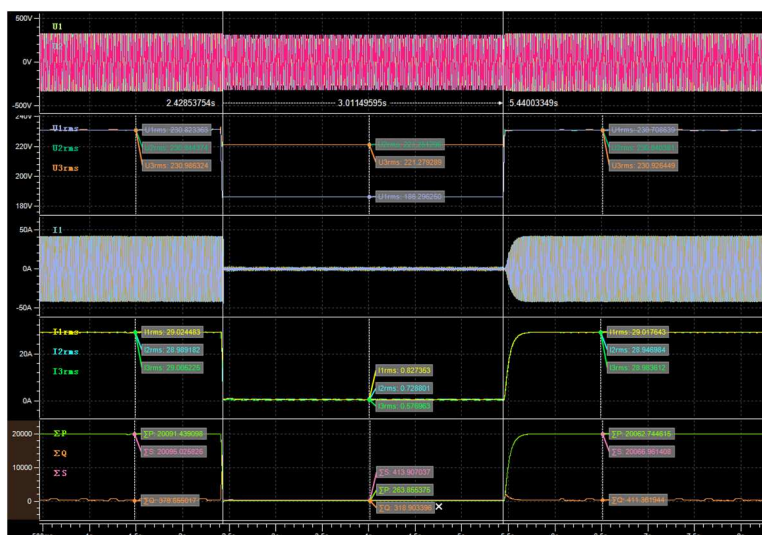
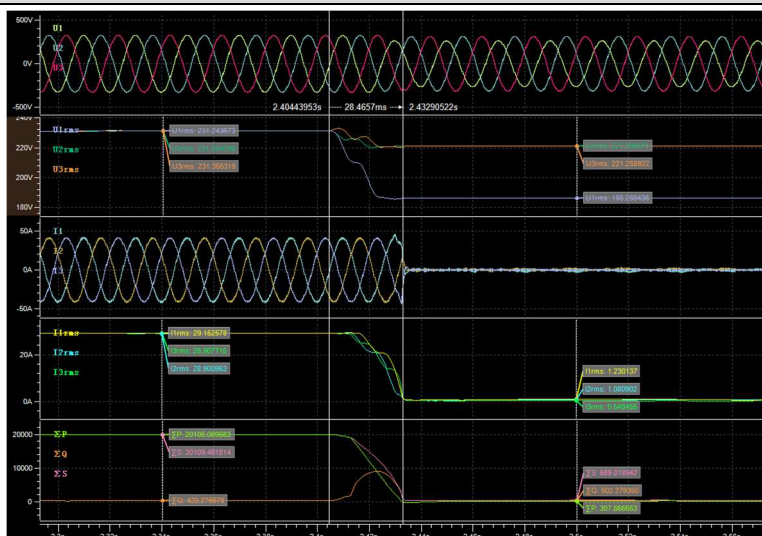

Test 3.B.1-Single phase fault ($U/U_{nom} = 0,82$); $P = 100\% \pm 5\% P_n$

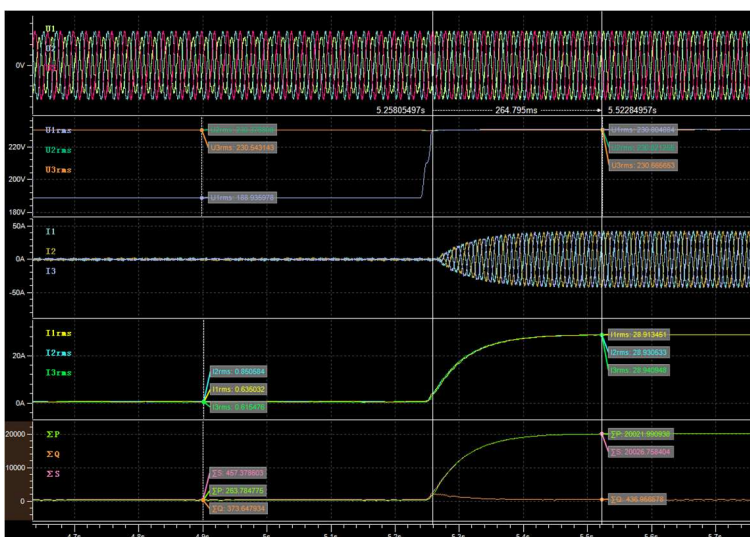
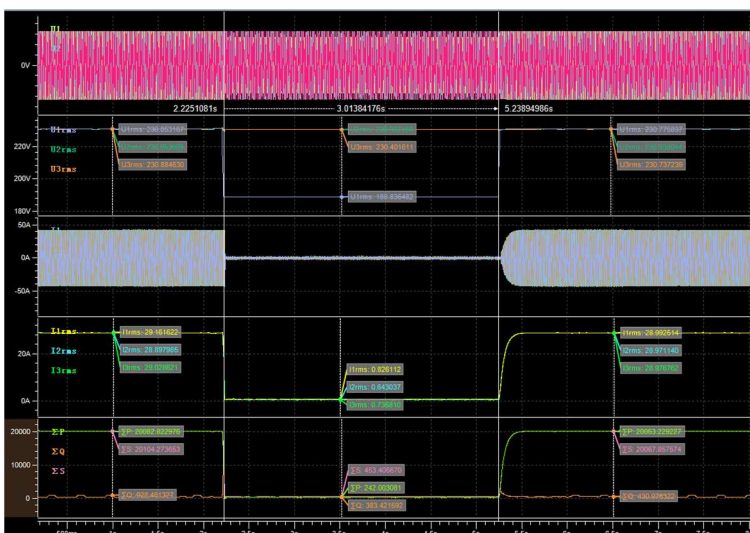
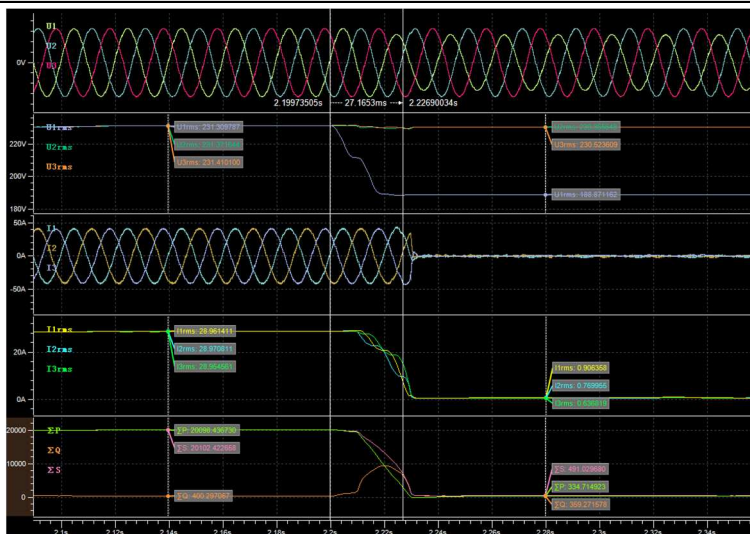

Test 1.A.2-Symmetrical fault ($U/U_{nom} = 0,03$); $P = 20\% \pm 5\% P_n$

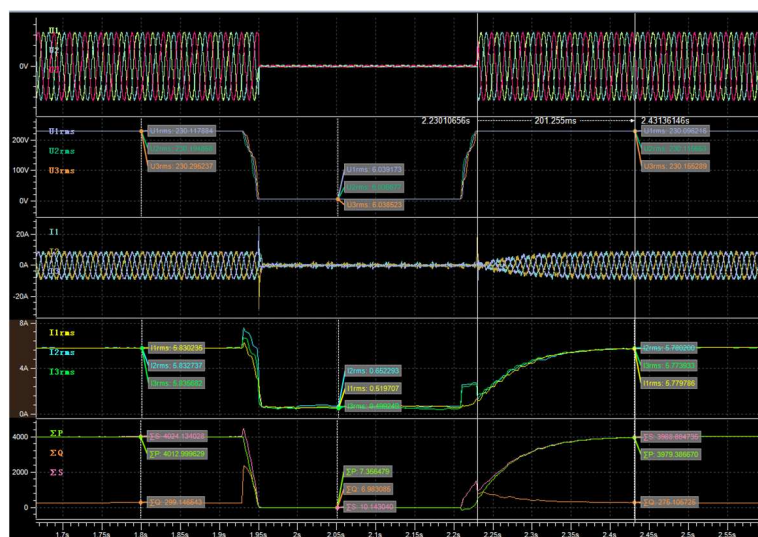
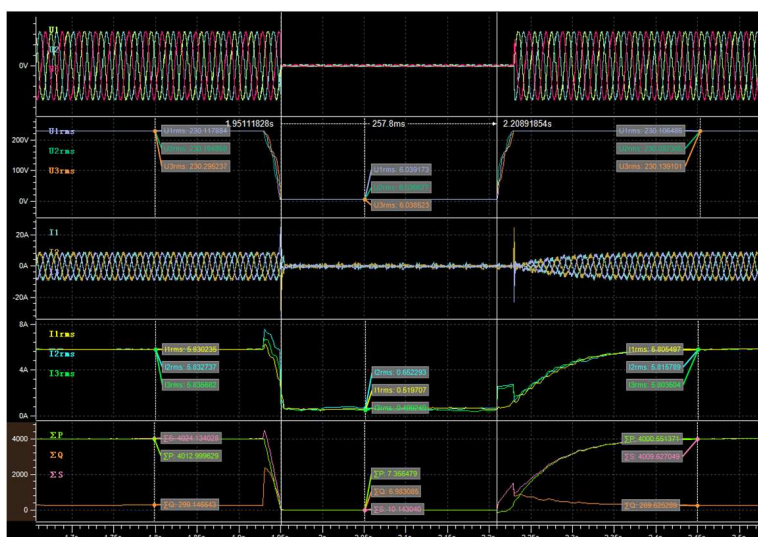
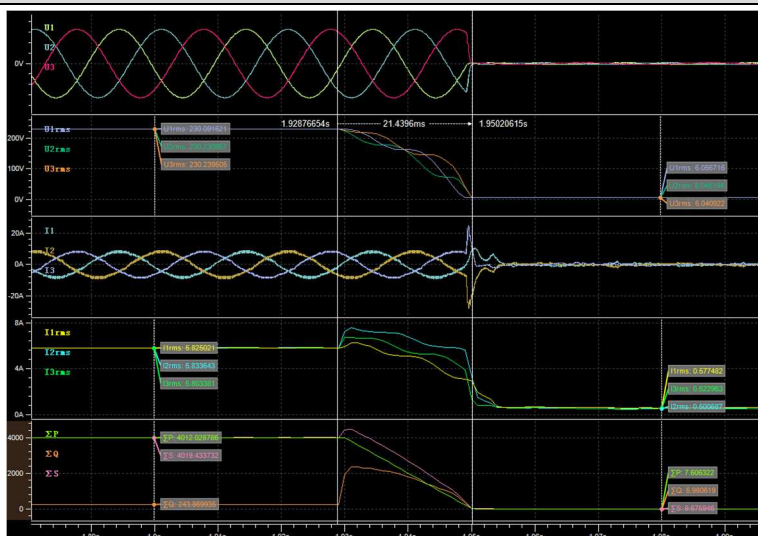

Test 1.D.2-Asymmetrical fault (U/U_{nom} = 0,03); P = 20% ±5% P_n

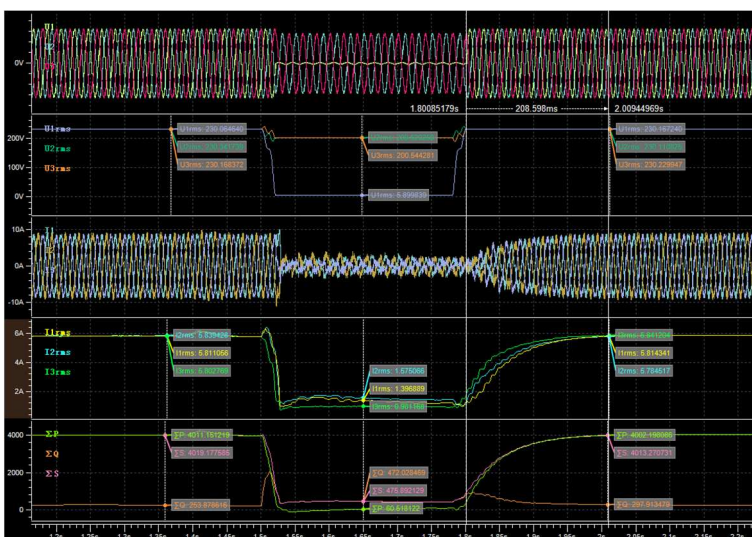
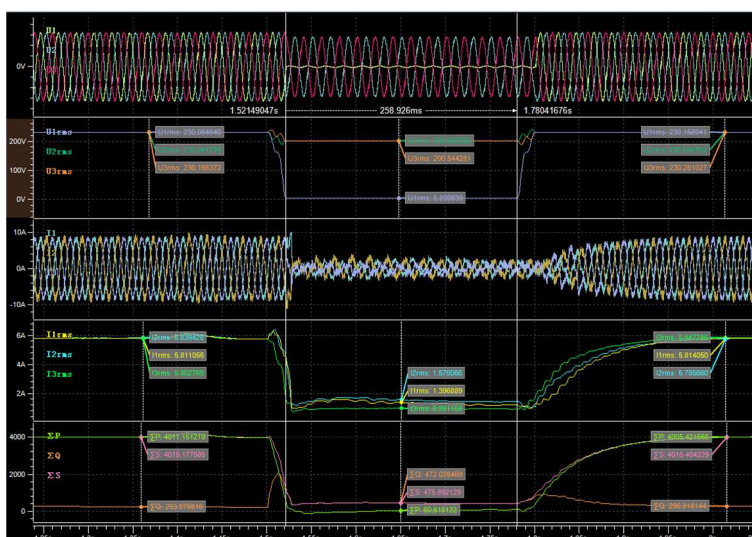
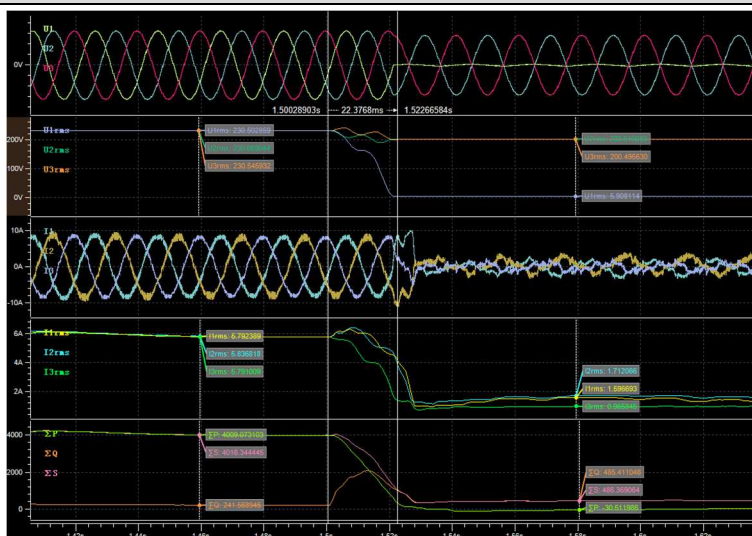

Test 1.B.2-Single phase fault ($U/U_{nom} = 0,03$); $P = 20\% \pm 5\% P_n$

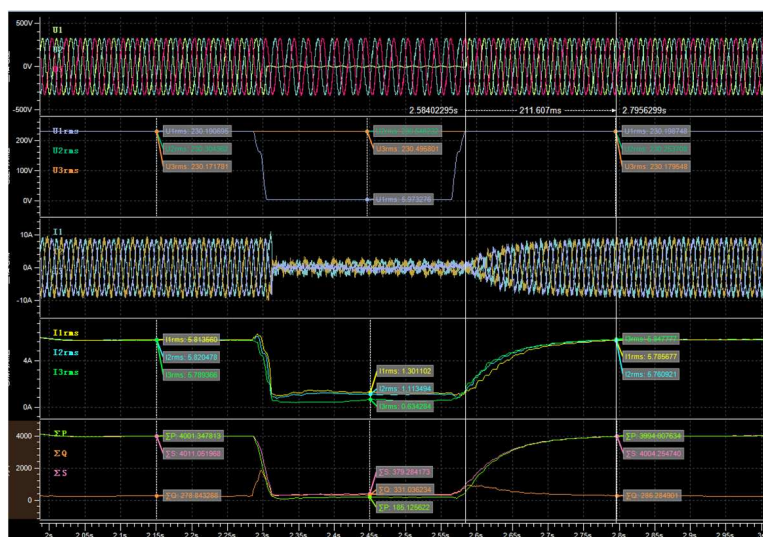
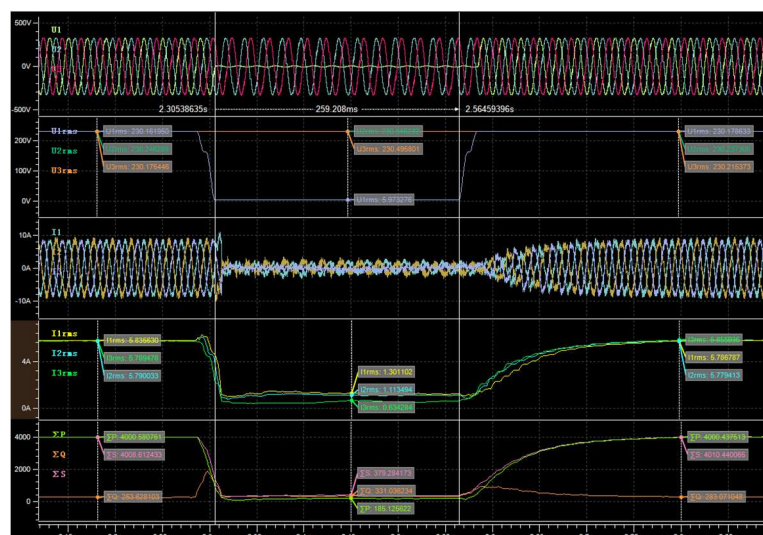
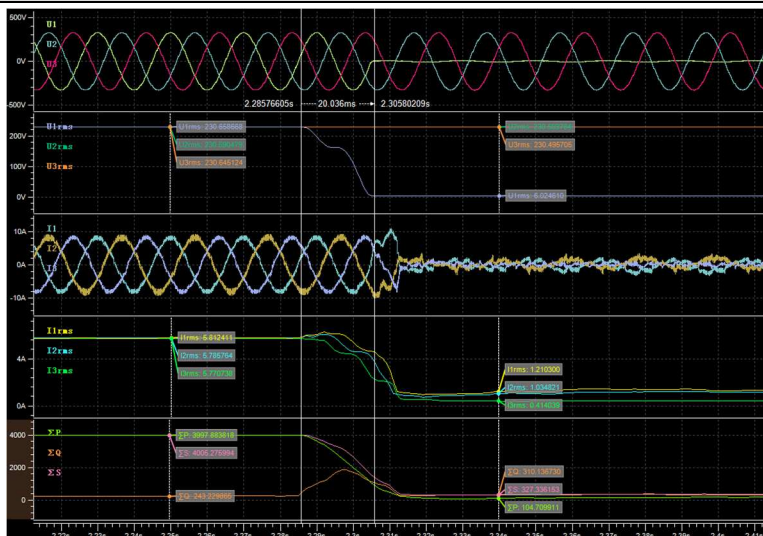

Test 2.A.2-Symmetrical fault ($U/U_{nom} = 0,31$); $P = 20\% \pm 5\% P_n$

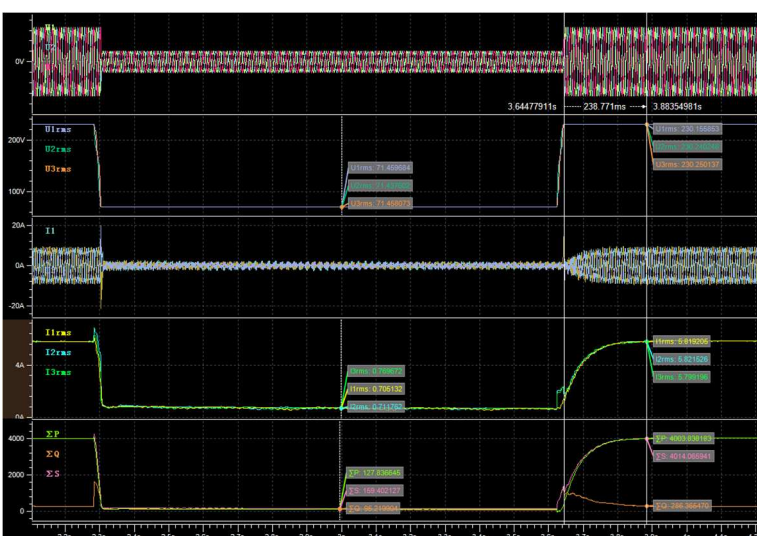
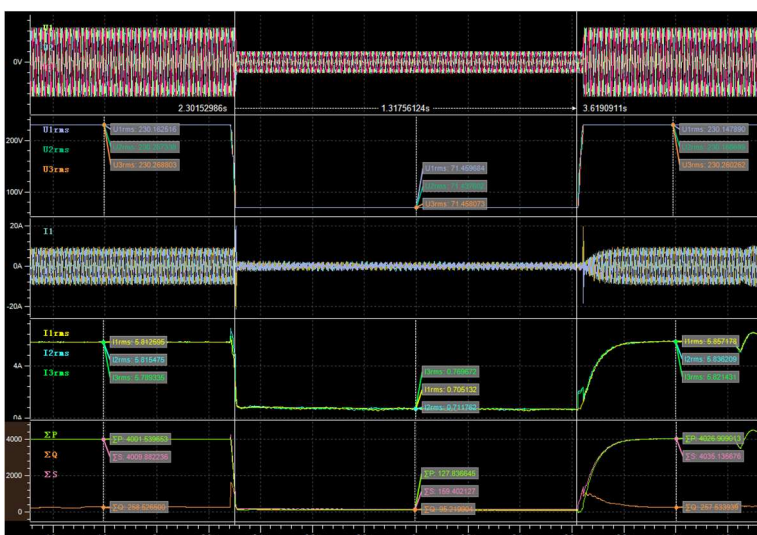
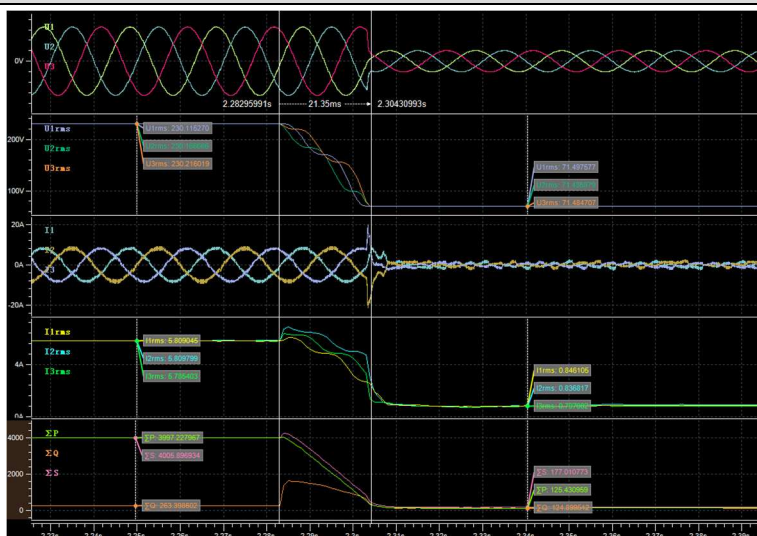

Test 2.D.2-Asymmetrical fault (U/U_{nom} = 0,31); P = 20% ±5% P_n

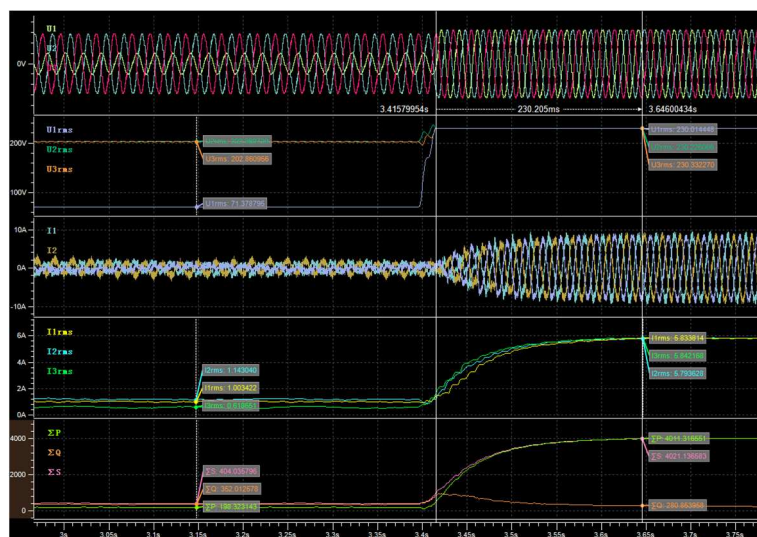
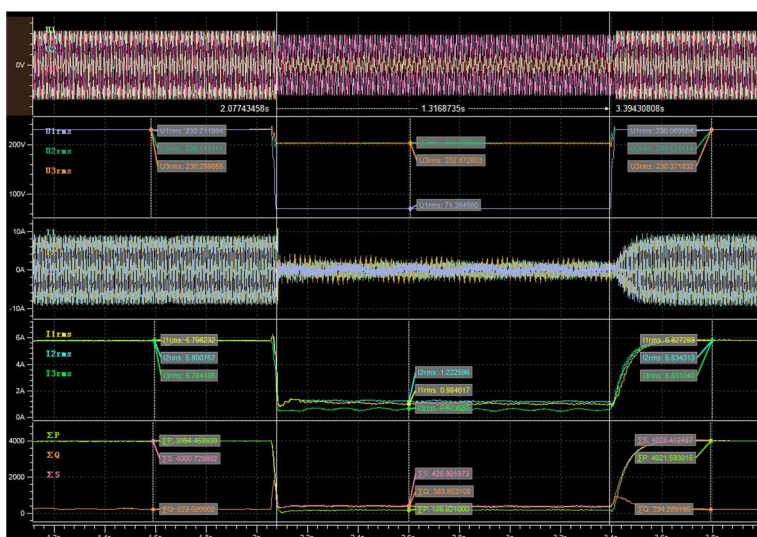
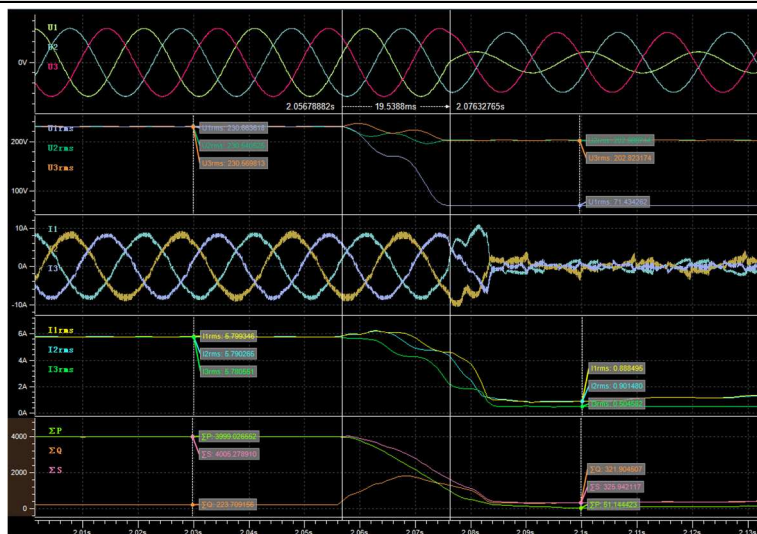

Test 2.B.2-Single phase fault ($U/U_{nom} = 0,31$); $P = 20\% \pm 5\% P_n$

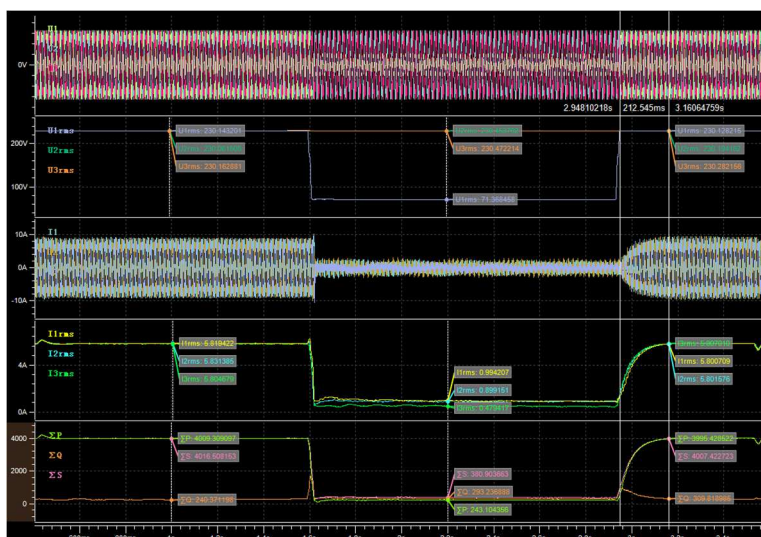
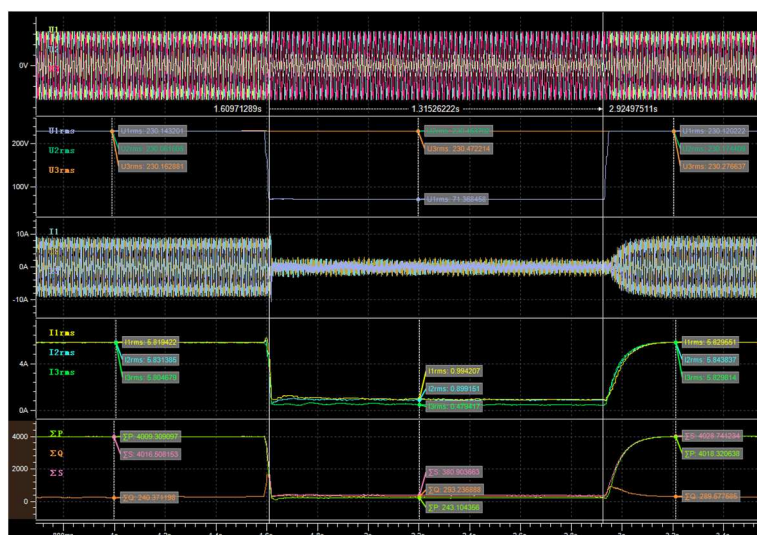
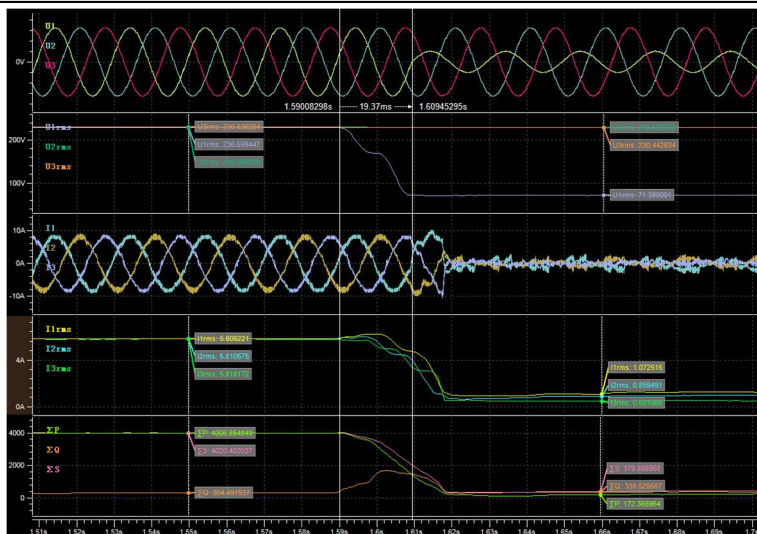

Test 3.A.2-Symmetrical fault (U/U_{nom} = 0,82); P = 20% ±5% P_n

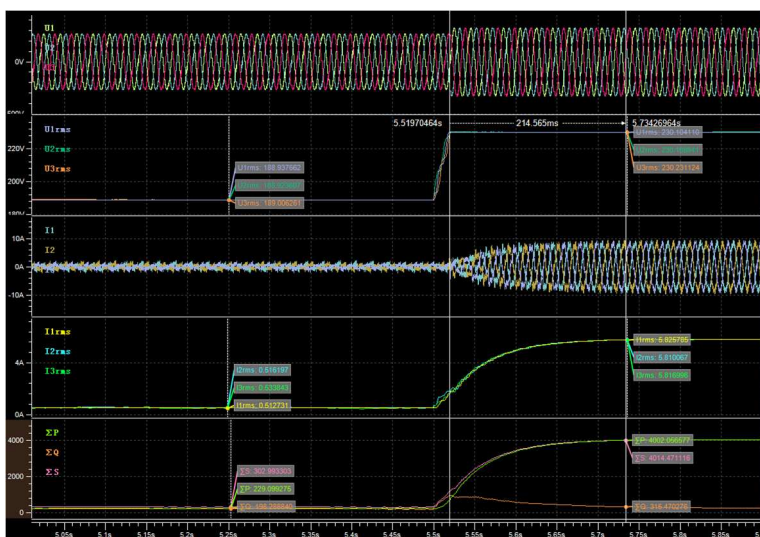
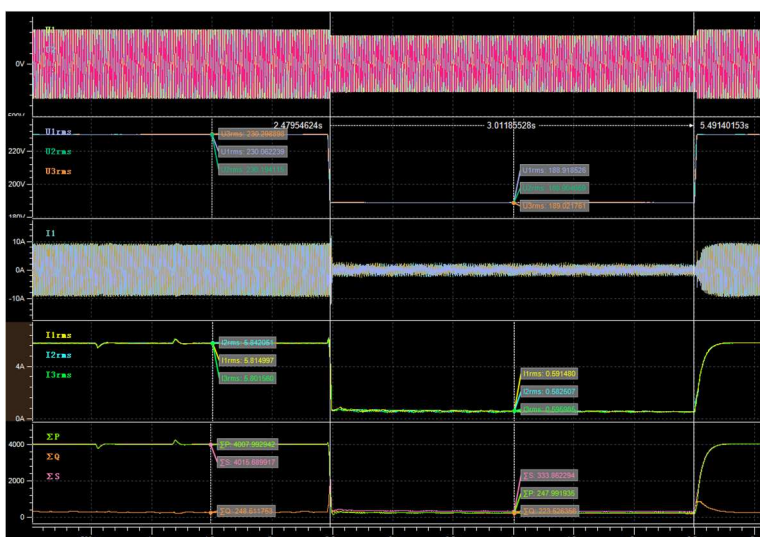
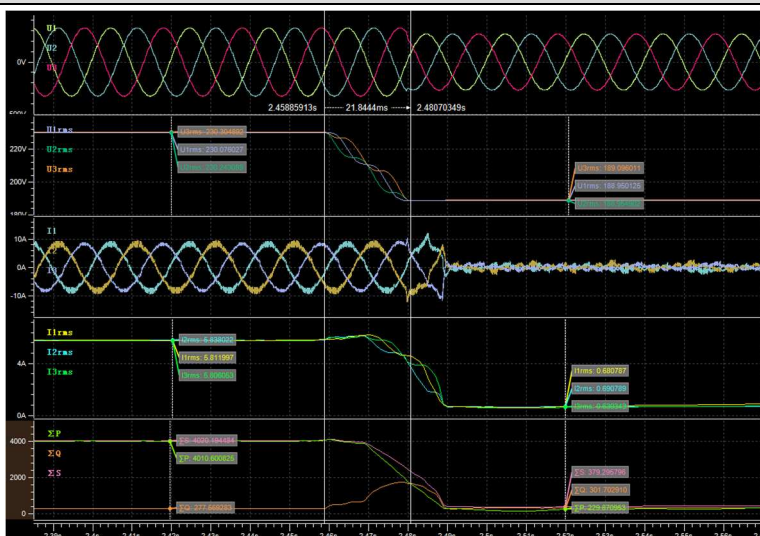

Test 3.D.2-Asymmetrical fault (U/U_{nom} = 0,82); P = 20% ±5% P_n

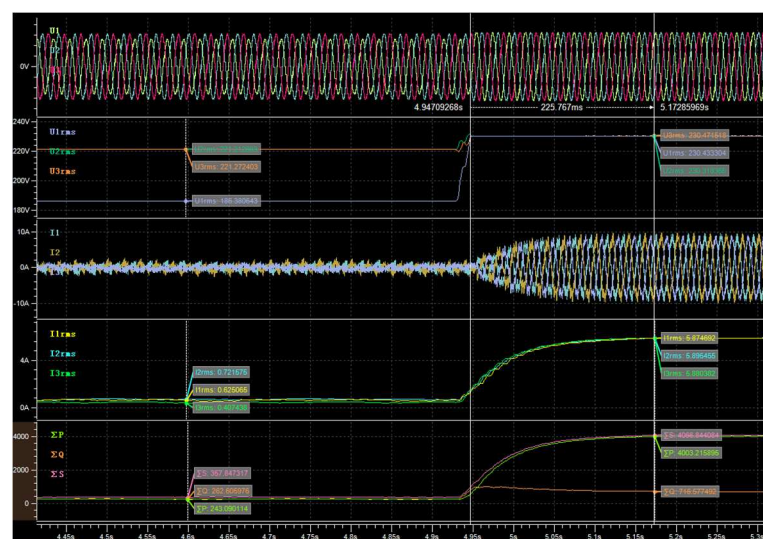
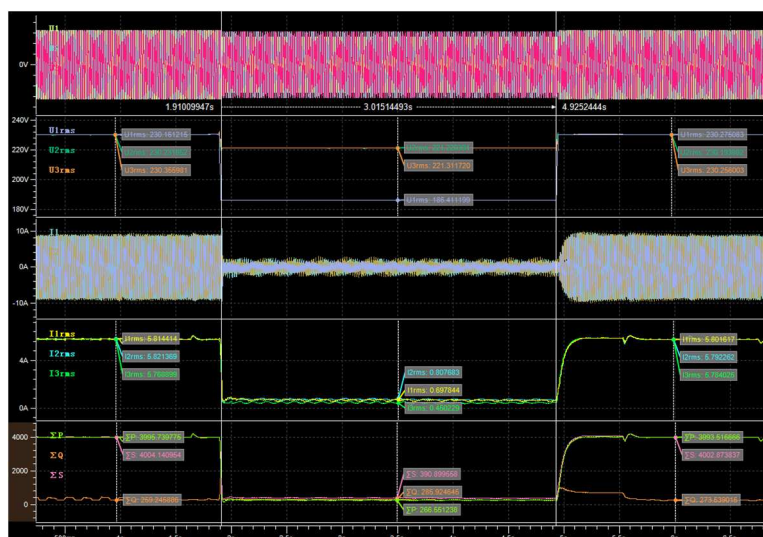
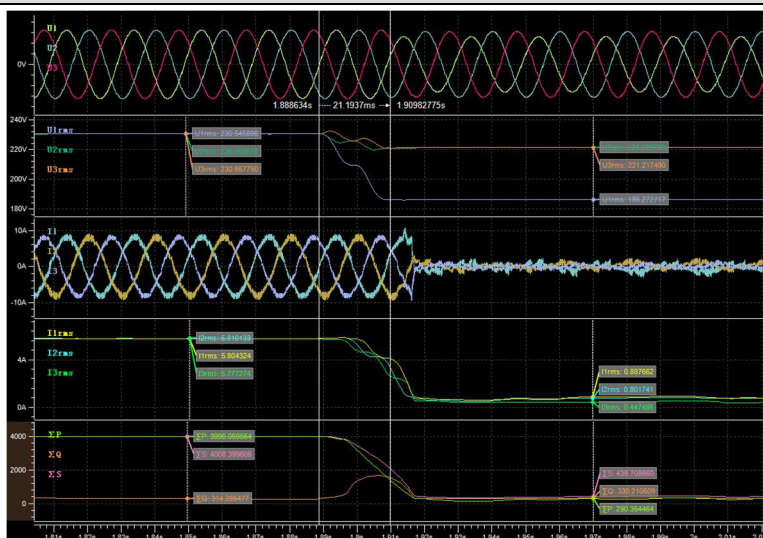

Test 3.B.2-Single phase fault ($U/U_{nom} = 0,82$); $P = 20\% \pm 5\% P_n$

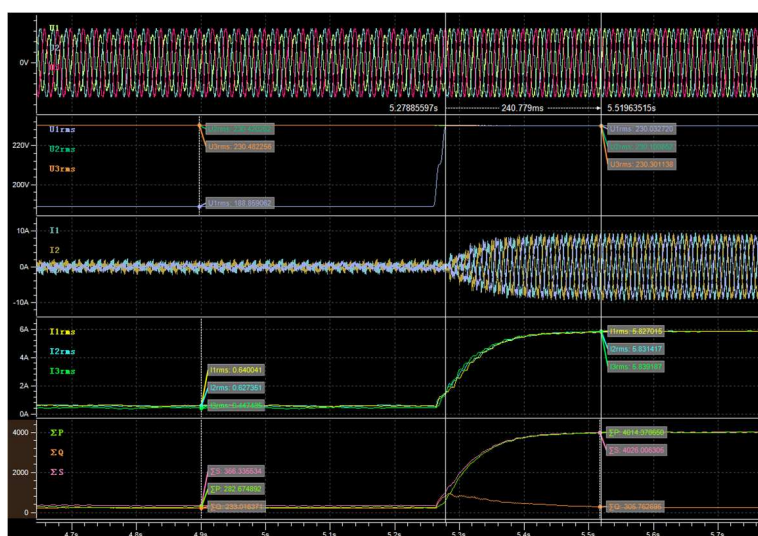
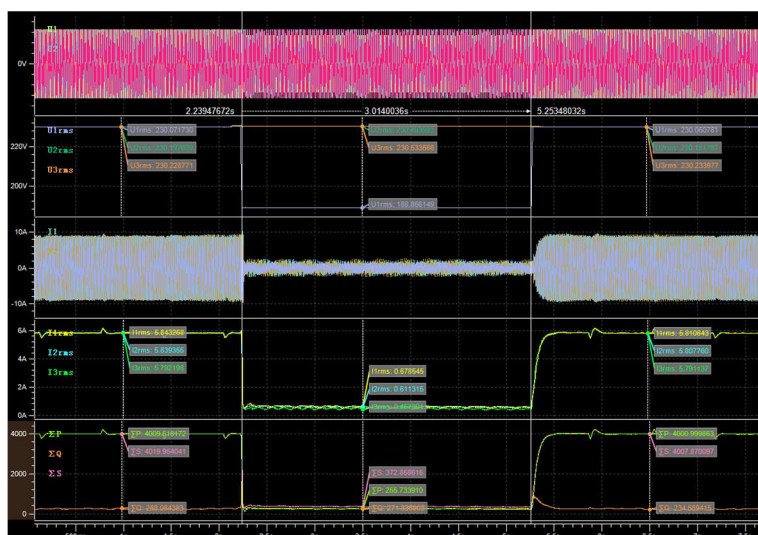
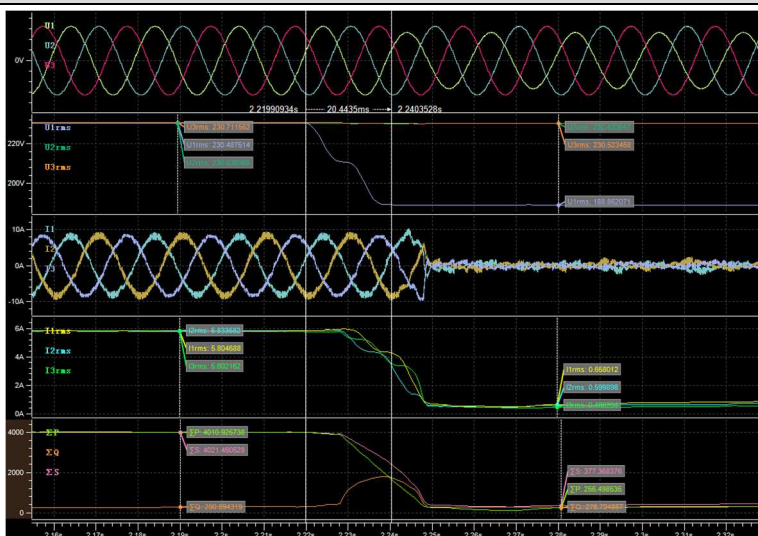

Test OV1-Symmetrical fault ($U/U_{nom} = 1,25$); $P = 100\% \pm 5\% P_n$

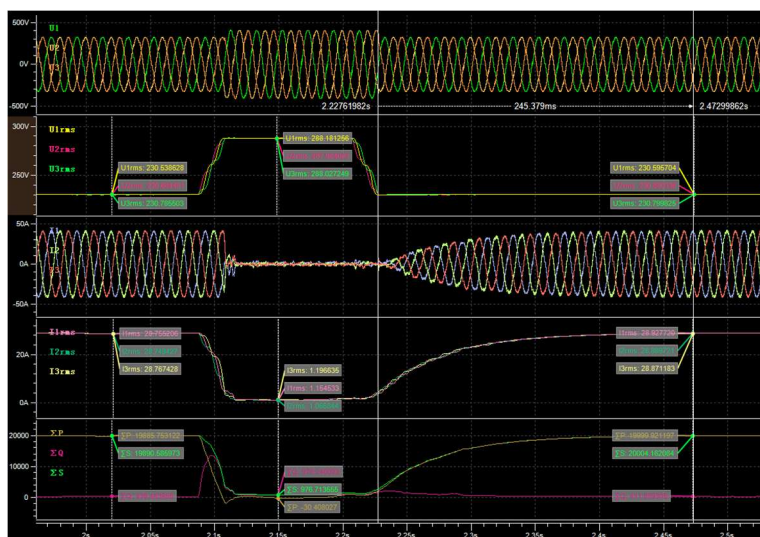
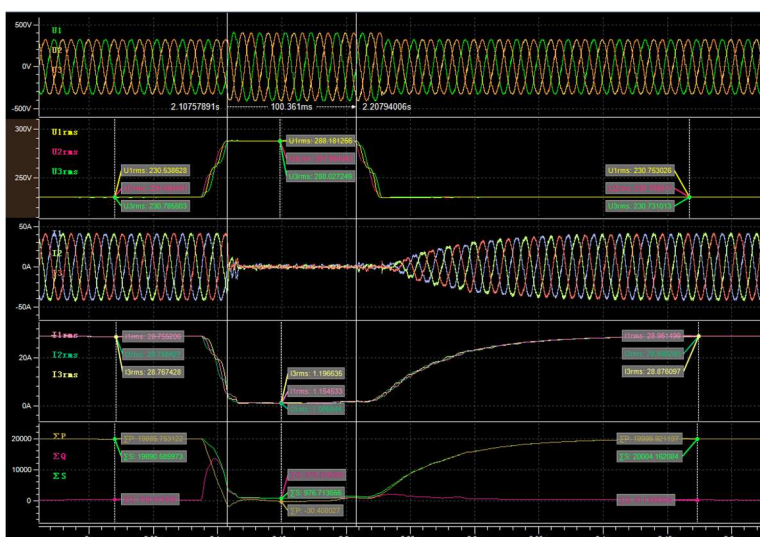
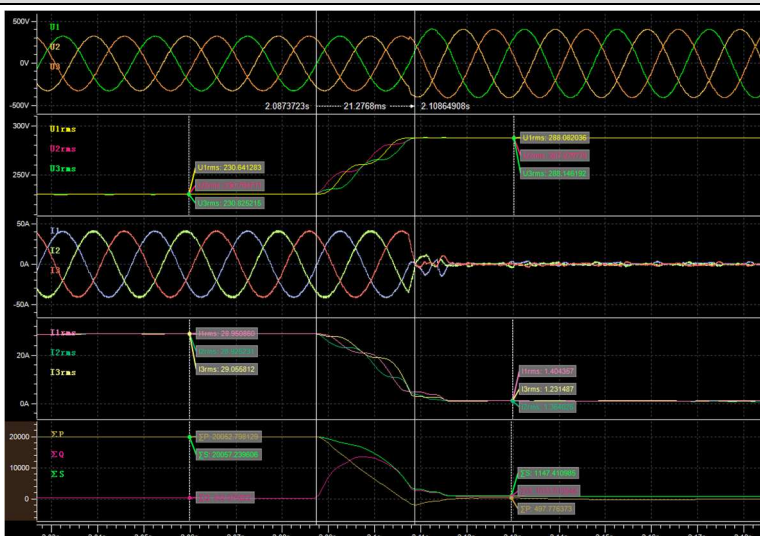

Test OV2-Symmetrical fault ($U/U_{nom} = 1,20$); $P = 100\% \pm 5\% P_n$

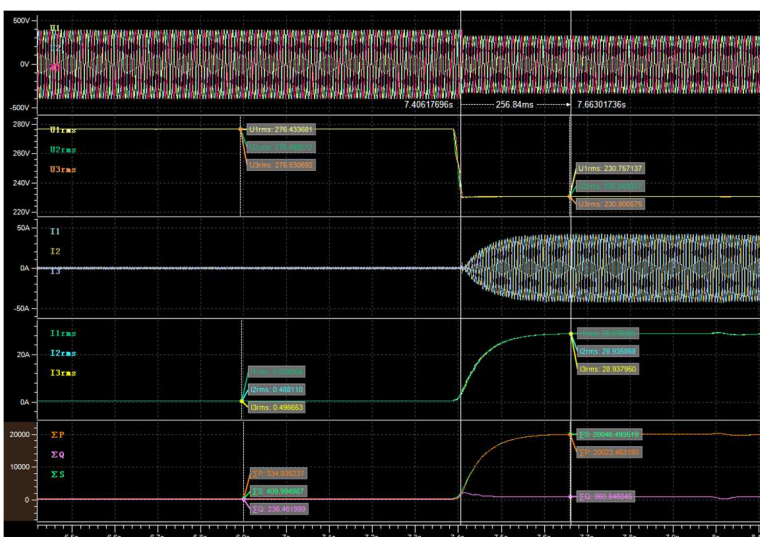
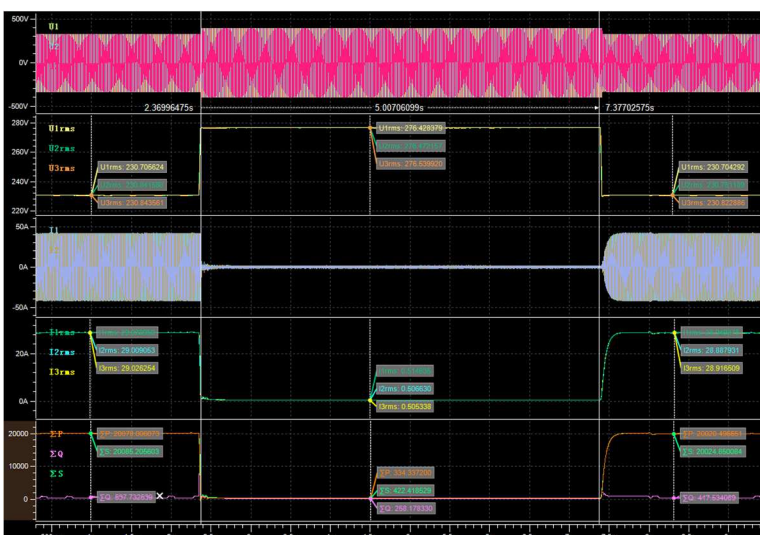
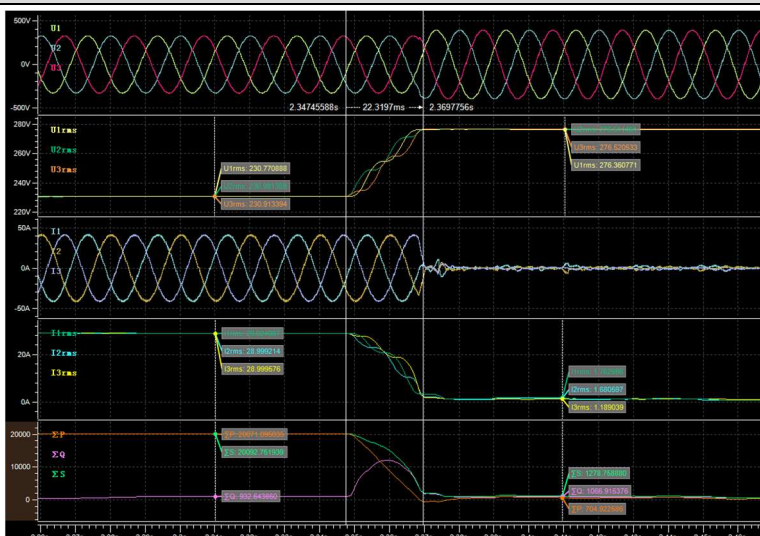

Test OV3-Symmetrical fault ($U/U_{nom} = 1,15$); $P = 100\% \pm 5\% P_n$

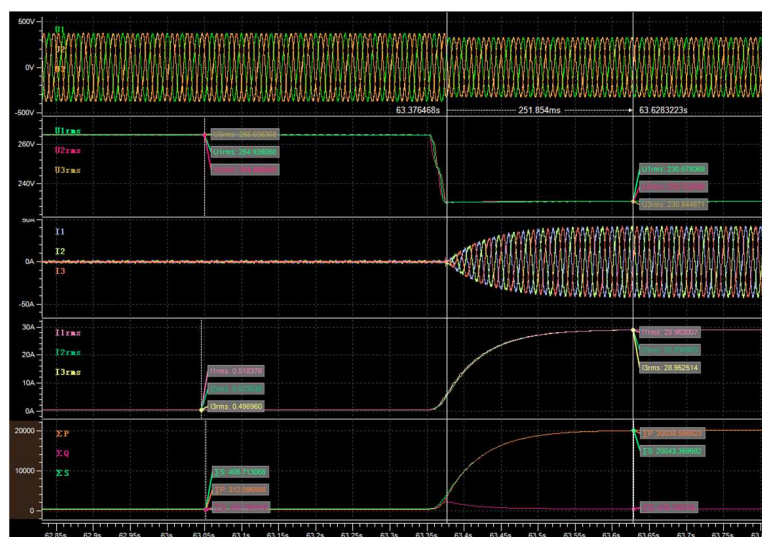
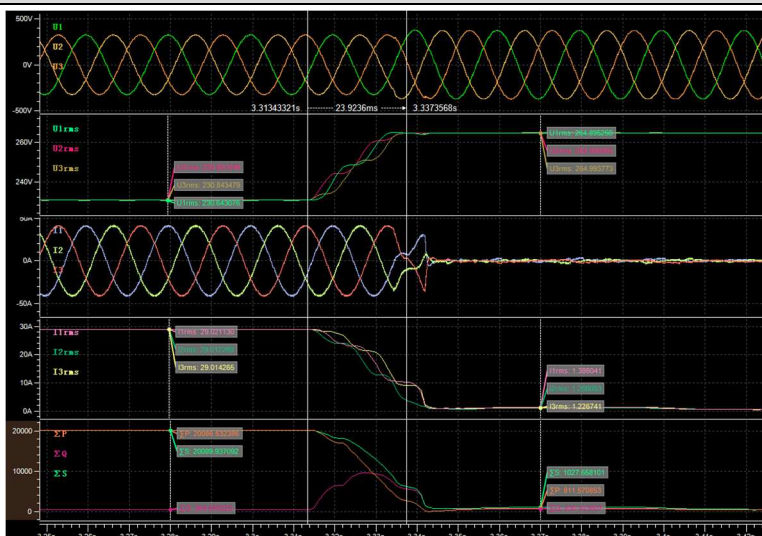

EN 50549-1:2019: Active response to frequency deviation

Clause	Test requirement	Test procedure according standard	Result
4.6.1	Power response to over-frequency	VDE V 0124-100:2019-02 (Draft), clause 5.4.4	P
4.6.2	Power response to under-frequency	VDE V 0124-100:2019-02 (Draft), clause 5.4.6	P

4.6.1 Power response to over-frequency	P
---	----------

Test result: HYD 20KTL-3PH

1-min mean value [Hz]:	a) 50,00	b) 50,25	c) 50,70	d) 51,40	e) 50,70	f) 50,25	g) 50,00
------------------------	----------	----------	----------	----------	----------	----------	----------

1. Measurement a) to g): Active power output = 100% $P_{E_{max}}$
 $s=5\%$ (40% P_{ref} / Hz), threshold frequency for start/return: 50,2Hz

Frequency [Hz]:	50,00	50,25	50,70	51,40	50,70	50,25	50,00
P_M [kW]:	N/A	19,638	16,038	10,439	16,038	19,638	N/A
P_{E60} [kW]:	20,077	19,645	16,076	10,510	16,076	19,645	20,075
$\Delta P_{E60}/P_M$ [%]:	N/A	0,03	0,19	0,36	0,19	0,03	N/A

2. Measurement a) to g): Active power output 60% after freezing = 100% $P_{E_{max}}$
 $s=5\%$ (40% P_{ref} / Hz), threshold frequency for start/return: 50,2Hz

Frequency [Hz]:	50,00	50,25	50,70	51,40	50,70	50,25	50,00
P_M [kW]:	N/A	11,668	8,068	2,468	8,069	11,668	N/A
P_{E60} [kW]:	12,085	11,678	8,107	2,526	8,106	11,684	20,079
$\Delta P_{E60}/P_M$ [%]:	N/A	0,05	0,19	0,29	0,19	0,08	N/A

Limit $\Delta P/P_{1min}$: $\pm 10\%$ of $P_{E_{max}}$

Graph of Measurement 1.: Active power output > 80% $P_{E_{max}}$

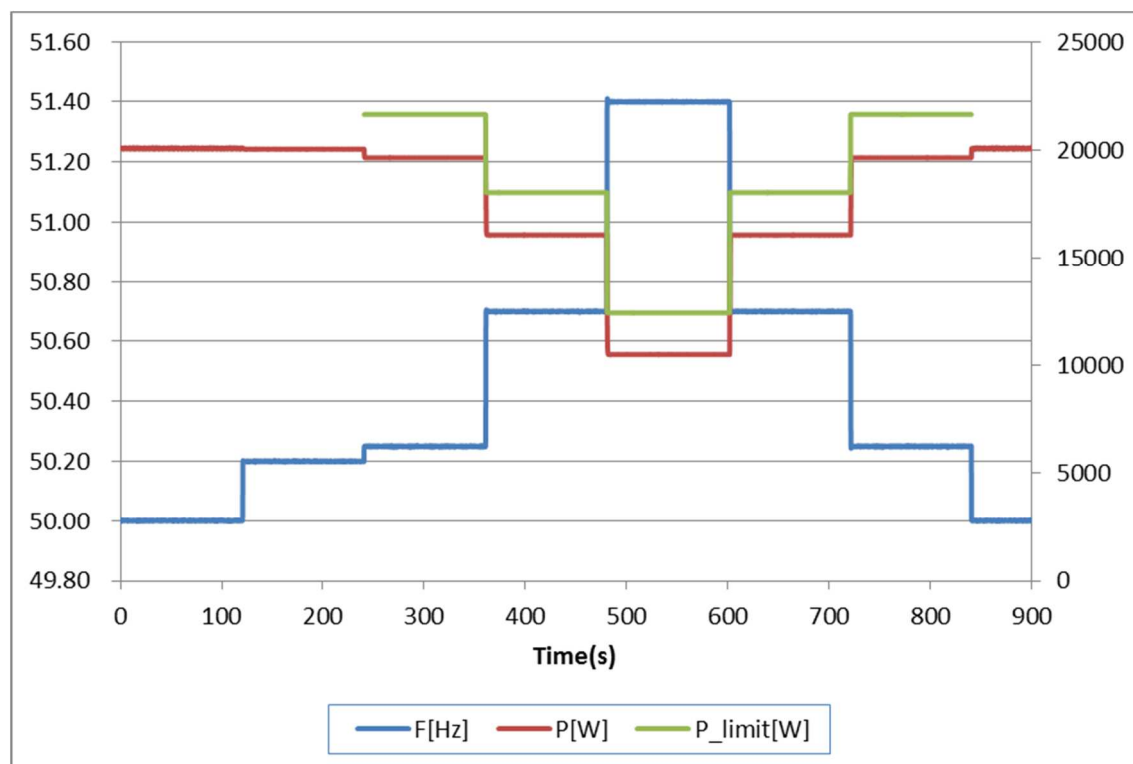

Graph of Measurement 2.:Active power output 40% and 60% after freezing > 80% P_n

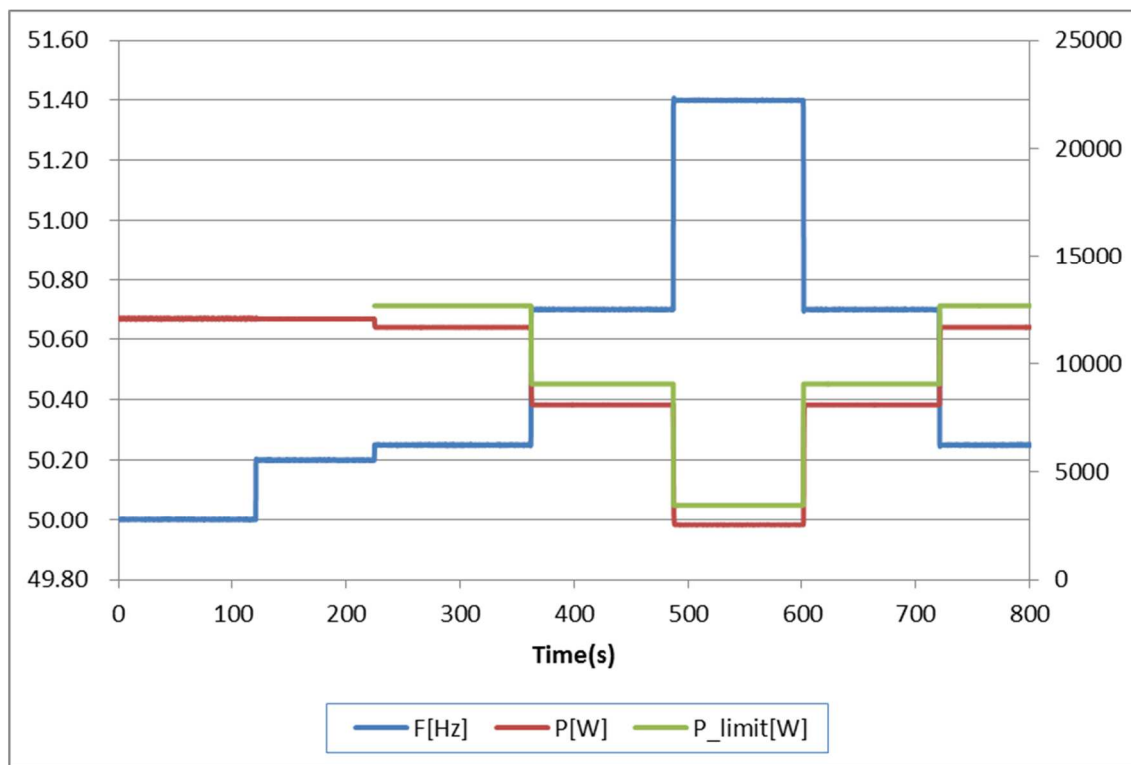

Graph of power gradient:

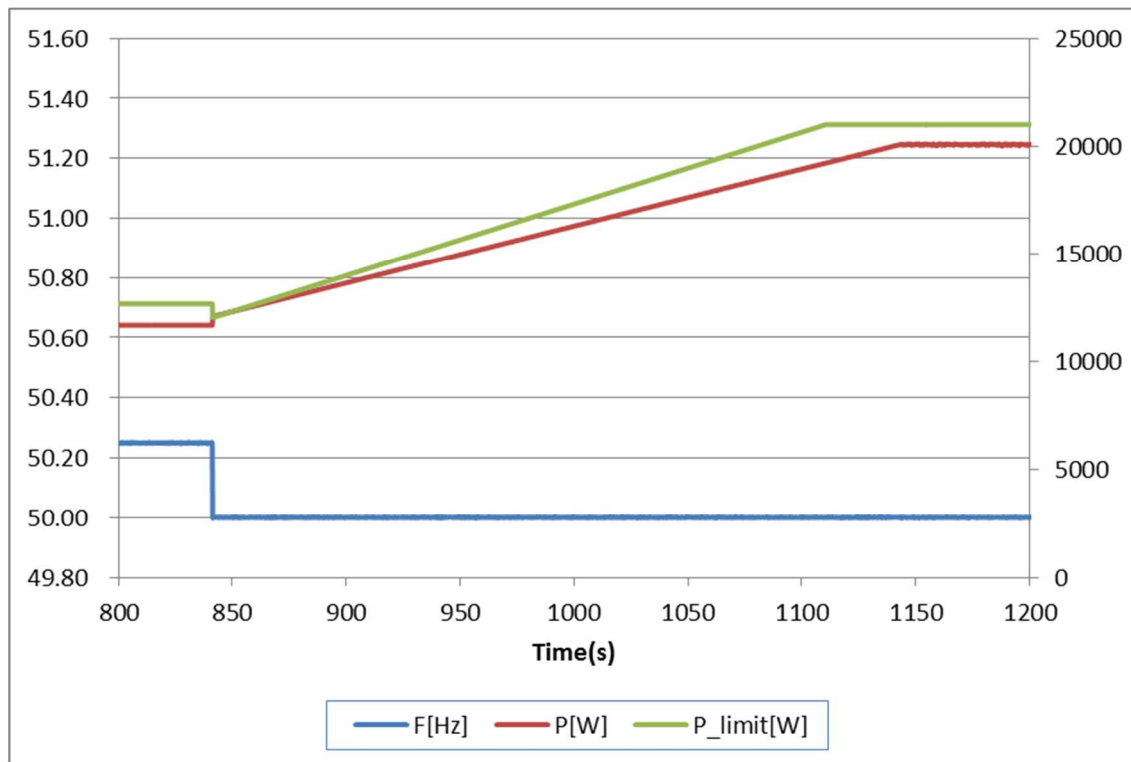

Test:

The test is conducted for two powers. First, the test must start at a power =100% $P_{E_{max}}$ ("Measurement 1"), and in a second test, for a power 60% $P_{E_{max}}$ ("Measurement 2"). In the second test, after freezing of the P_M , the available active power output must be increased to a value =100% $P_{E_{max}}$, and after the network frequency of 50,2 Hz is fallen below, the rise of the active power gradient must be recorded.

Point g) must be held until the micro-generator is again feeding in with the active power output available.

Assessment criterion:

For $f = 50,2$ Hz, the value of the P_M active power currently being generated is "frozen".

a) For adjustable micro-generators when:

- 1) the active power reduces between measuring points b) and f) given above with the set gradient P_M per Hz for a increasing frequency (or rises for a frequency decreasing again).
- 2) the maximum active power gradient occurring in point is less than the configured maximum active power per minute
- 3) the reaction value of the setpoint determined by the gradient characteristic curve does not differ from $P_{E_{max}}$ by more than $\pm 10\%$.
- 4) the settling time is equal or below 2 s with an intentional delay set to zero

b) For partly adjustable micro-generators

- 1) when they behave as in a) within their adjustment range, and
- 2) when, outside the adjustable range, the power fed in on leaving the adjustment range remains constant until shutdown. Shutdown must be no later than at 51,5 Hz.

Note:

The test method refer to clause 5.4.4 of VDE V 0124-100:2019-02 (Draft).

The tests had been performed on the HYD 20KTL-3PH is valid for the HYD 15KTL-3PH, HYD 10KTL-3PH, HYD 8KTL-3PH, HYD 6KTL-3PH and HYD 5KTL-3PH since it is similar in hardware and just power derated by software.

The test results refer to the test report "PV200302N015-6" issued by Bureau Veritas Shenzhen Co., Ltd.

Dongguan Branch, dated on 2020.08.21.

4.6.2 Power response to over-frequency (For synchronous generating and Electrical Energy Storage System unit (EES) only)							P
Test result: HYD 20KTL-3PH							
1-min mean value [Hz]:	a) 50,00	b) 49,75	c) 48,80	d) 47,60	e) 48,80	f) 49,75	g) 50,00
1. Measurement a) to g): Active power output = $-20\% \pm 5\% P_{E_{max}}$ s=5% (40% $P_{E_{max}}$ / Hz), threshold frequency for start/return: 49,8Hz							
Frequency [Hz]:	50,00	49,75	48,80	47,60	48,80	49,75	50,00
P_M [kW]:	N/A	-3,454	4,146	13,746	4,146	-3,454	N/A
P_{E60} [kW]:	-3,956	-3,455	4,112	13,647	4,112	-3,451	-3,955
$\Delta P_{E60}/P_M$ [%]:	N/A	-0,004	-0,171	-0,495	-0,169	0,015	N/A
1-min mean value [Hz]: a) 50,00 b) 49,75 c) 48,80 d) 47,60 e) 48,80 f) 49,85 g) 50,00							
2. Measurement a) to g): Active power output = $10\% \pm 5\% P_{E_{max}}$ s=5% (40% $P_{E_{max}}$ / Hz), threshold frequency for start/return: 49,8Hz							
Frequency [Hz]:	50,00	49,75	48,80	47,60	48,80	49,85	50,00
P_M [kW]:	N/A	2,365	9,964	19,565	9,964	N/A	N/A
P_{E60} [kW]:	1,841	2,362	9,918	19,446	9,919	1,847	1,848
$\Delta P_{E60}/P_M$ [%]:	N/A	-0,015	-0,228	-0,592	-0,226	N/A	N/A
3. Measurement a) to g): Active power output = $60\% \pm 5\% P_{E_{max}}$ s=5% (40% $P_{E_{max}}$ / Hz), threshold frequency for start/return: 49,8Hz							
Frequency [Hz]:	50,00	49,75	48,80	47,60	48,80	49,85	50,00
P_M [kW]:	N/A	12,168	19,769	20,000	19,769	N/A	N/A
P_{E60} [kW]:	11,613	12,173	19,730	19,910	19,727	11,650	11,654
$\Delta P_{E60}/P_M$ [%]:	N/A	0,024	-0,195	-0,448	-0,209	N/A	N/A
Limit $\Delta P/P_{1min}$:	$\pm 10\%$ of $P_{E_{max}}$						
Test: The test method refer to clause 5.4.7 of VDE V 0124-100:2019-02 (Draft) All generating units must increase the currently generated available active power PA with a gradient of 40% $P_{E_{max}}$ per Hertz (s = 5%) up to their technically possible maximum value at frequencies below 49,8 Hz. The maximum value is determined by the current primary energy supply as well as the currently usable storage capacity. Power reductions, which serve to protect equipment, are also permitted at underfrequency. While grid frequency is over frequency protection (Ex. $f < 47,5$ Hz), the generating units shall be disconnected from the power supply when supplying energy. It follows that generating units and memory also in the frequency range between 49,8 Hz and 47,5 Hz or 47,8 Hz with respect to their maximum possible active power feed permanently on the frequency characteristic up and down move („driving on the curve“)							

Assessment criterion:

The generating plant shall be capable of activating active power response to under frequency as fast as technically feasible with an intrinsic dead time that shall be as short as possible with a maximum of 2 s and with a step response time of maximum 30 s.

After settling time, the delivered active power should deviate from the nominal value by less than $\pm 10\%$ P_{Emax} .

Note:

The test method refer to clause 5.4.4 of VDE V 0124-100:2019-02 (Draft).

The tests had been performed on the HYD 20KTL-3PH is valid for the HYD 15KTL-3PH, HYD 10KTL-3PH, HYD 8KTL-3PH, HYD 6KTL-3PH and HYD 5KTL-3PH since it is similar in hardware and just power derated by software.

The test results refer to the test report "PV200302N015-6" issued by Bureau Veritas Shenzhen Co., Ltd. Dongguan Branch, dated on 2020.08.21.

Graph of Measurement 1.:

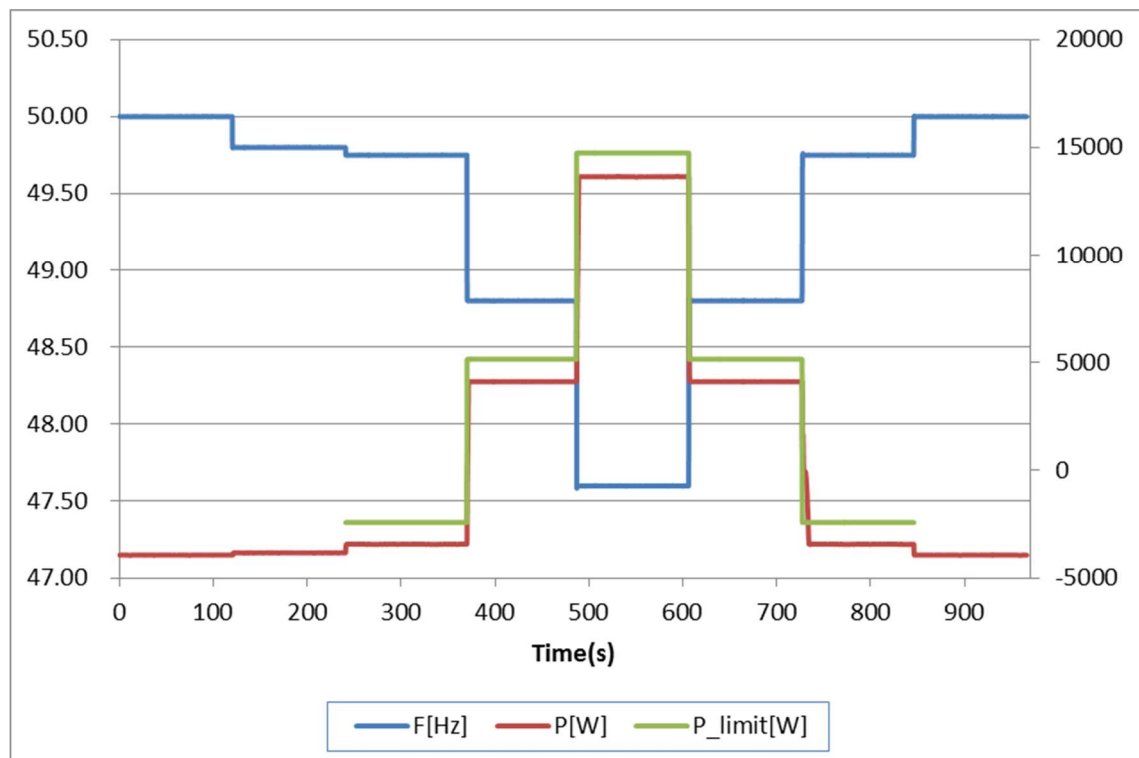

Graph of Measurement 2.:

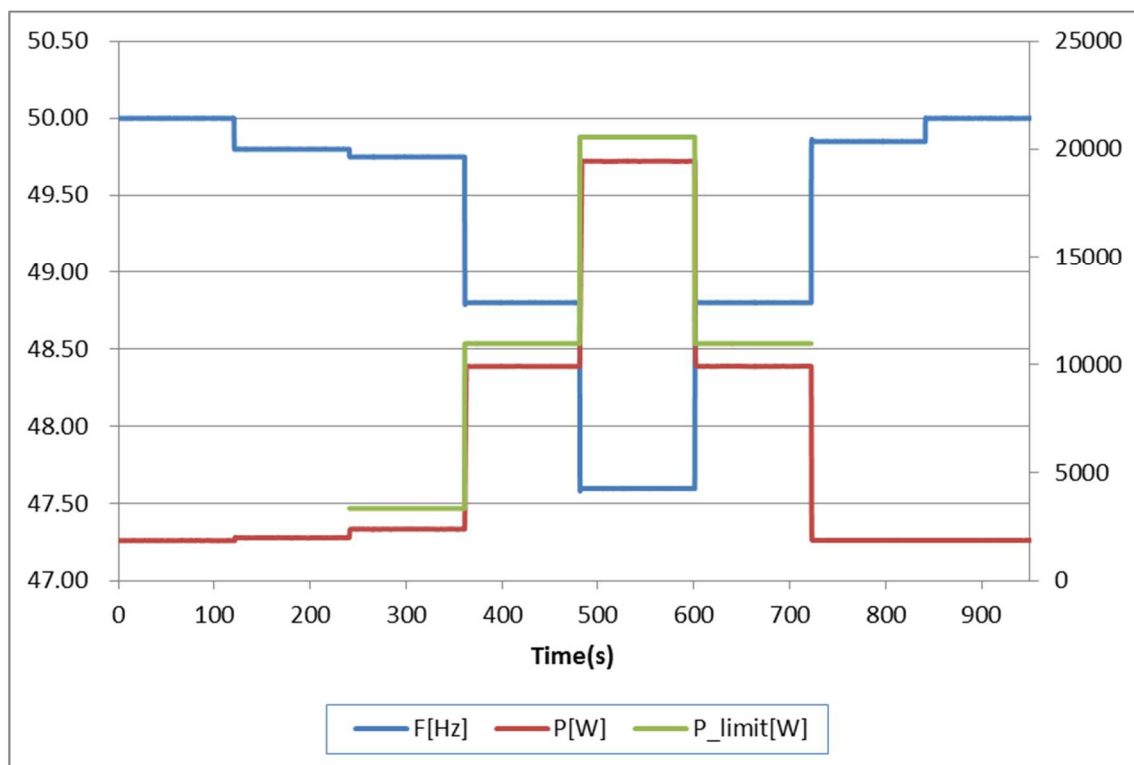

Graph of Measurement 3.:

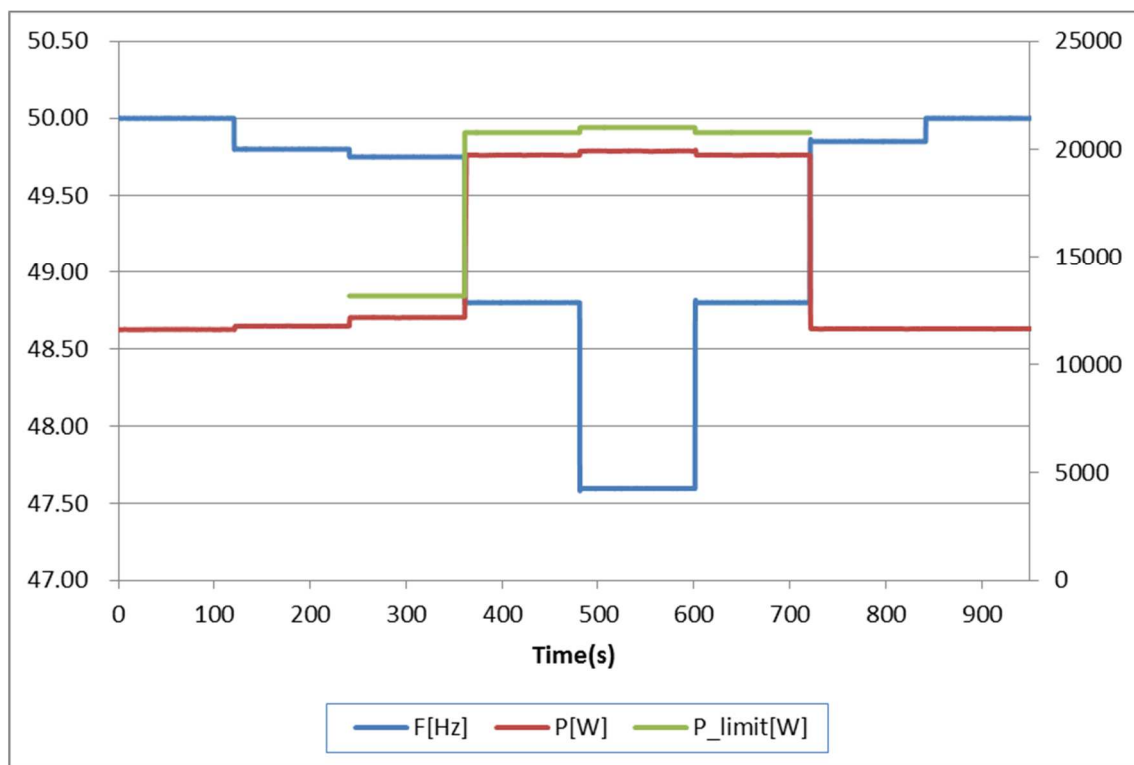

EN 50549-1:2019: Power response to voltage variations and voltage changes

Clause	Test requirement	Test procedure according standard	Result
4.7.2.2	Capabilities	--	P
4.7.2.3.2	Fix control modes (<u>cos ϕ setpoint mode</u>)	FGW TG3, Revision 25, clause 4.2.2	P
4.7.2.3.2	Fix control modes (<u>Q setpoint mode, 48,43%</u>)	EN 50438:2013, Annex D.3.4.2.1	P
4.7.2.2	Q Response time	CEI 0-21:2019-04, Annex B.1.2.4	P
4.7.2.3.3	Voltage related control modes (Q (U) controls)	VDE AR 4105:2018-05, clause 5.7.2.4.	P
4.7.2.3.4	Power related control modes (cos ϕ (P) curve)	VDE V 0124-100:2012, clause 5.3.6.4	P
4.7.3	Voltage related active power reduction (P(U) function)	CEI 0-21:2019-04, Annex B.1.3.1	P

4.7.2 Voltage support by reactive power				P
4.7.2.2 Capabilities				
4.7.2.3.2 Fix control modes (cos φ setpoint mode)				
Test result: HYD 20KTL-3PH				
PF = 0,9 / Inductive reactive power supply				
Rating power [%]	Active power [kW]	Reactive power [kVar]	Power factor [cos φ]	DC power [kW]
10%	1,973	-0,937	0,9033	2,040
20%	3,999	-1,896	0,9036	4,097
30%	6,019	-2,829	0,9050	6,153
40%	8,032	-3,986	0,8958	8,206
50%	10,041	-4,977	0,8960	10,259
60%	12,047	-5,970	0,8960	12,313
70%	14,035	-6,955	0,8960	14,362
80%	16,029	-7,944	0,8960	16,413
90%	18,016	-8,934	0,8959	18,461
100%	19,936	-9,891	0,8958	20,448
PF = 0,9 / Capacitive reactive power supply				
Rating power [%]	Active power [kW]	Reactive power [kVar]	Power factor [cos φ]	DC power [kW]
10%	1,976	0,965	0,8985	2,041
20%	4,010	1,982	0,8964	4,098
30%	6,032	3,007	0,8950	6,152
40%	8,048	4,020	0,8946	8,207
50%	10,063	4,744	0,9045	10,262
60%	12,071	5,698	0,9043	12,315
70%	14,061	6,645	0,9041	14,363
80%	16,058	7,597	0,9039	16,415
90%	18,047	8,550	0,9037	18,462
100%	20,033	9,505	0,9035	20,511

Cos phi=1 no reactive power supply

Rating power [%]	Active power [kW]	Reactive power [kVar]	Power factor [cos φ]	DC power [kW]
10%	1,969	-0,066	0,9897	2,040
20%	4,009	0,054	0,9979	4,097
30%	6,034	0,069	0,9989	6,151
40%	8,056	0,082	0,9992	8,206
50%	10,072	0,093	0,9994	10,258
60%	12,084	0,107	0,9995	12,312
70%	14,088	0,121	0,9995	14,360
80%	16,081	0,137	0,9996	16,409
90%	18,080	0,148	0,9996	18,459
100%	20,069	0,170	0,9996	20,502

Assessment criterion:

The power factor resulting in each of the measurement points between 20 % and 90 % of the nominal power is equal to or lower than 0,90 both in over excited and under excited operation.

The tests had been performed on the HYD 20KTL-3PH is valid for the HYD 15KTL-3PH, HYD 10KTL-3PH, HYD 8KTL-3PH, HYD 6KTL-3PH and HYD 5KTL-3PH since it is similar in hardware and just power derated by software.

The test results refer to the test report "PV200302N015-6" issued by Bureau Veritas Shenzhen Co., Ltd. Dongguan Branch, dated on 2020.08.21.

Diagram

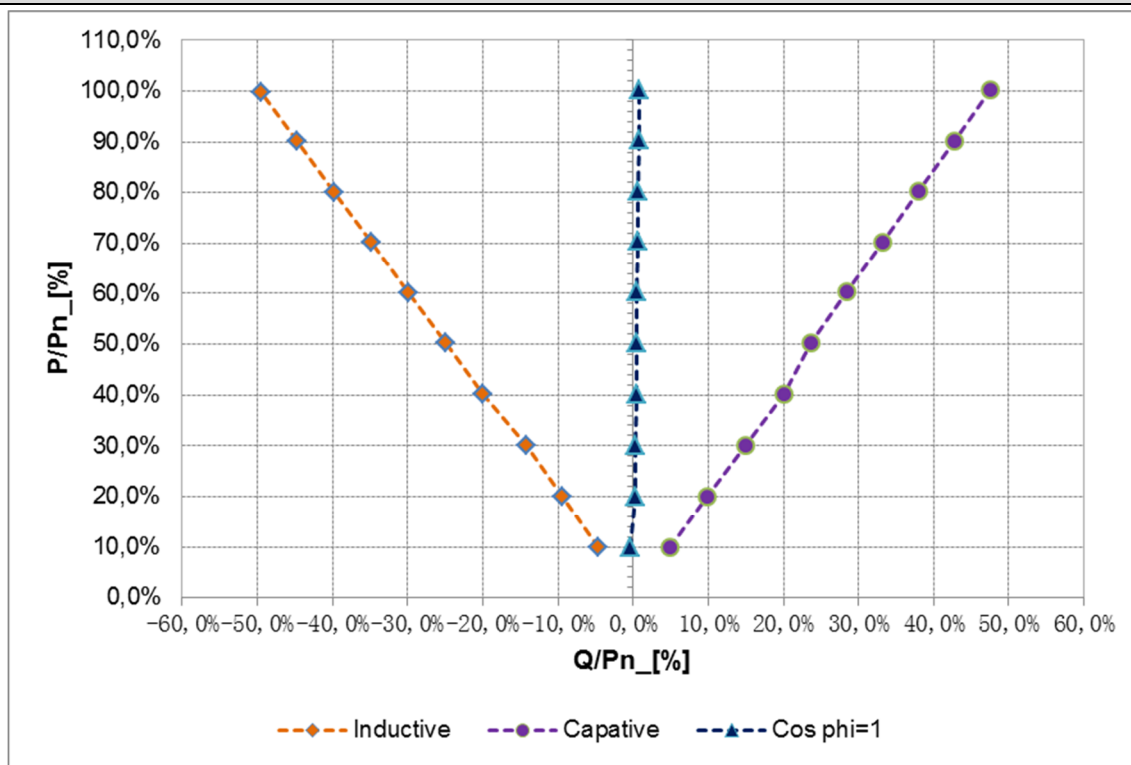

4.7.2 Voltage support by reactive power				P
4.7.2.2 Capabilities				
4.7.2.3.2 Fix control modes (Q setpoint mode, 48,43%)				
Test result: HYD 20KTL-3PH				
Inductive reactive power supply				
Rating power [%]	Active power [kW]	Reactive power [kVar]	Power factor [cos φ]	DC power [kW]
10%	1,829	-8,747	0,205	2,045
20%	3,663	-8,715	0,388	3,905
30%	5,433	-8,704	0,530	5,704
40%	7,257	-8,720	0,640	7,563
50%	9,075	-8,737	0,720	9,420
60%	10,883	-8,752	0,779	11,274
70%	12,648	-8,768	0,822	13,089
80%	14,446	-8,745	0,856	14,941
90%	16,281	-8,762	0,881	16,834
100%	18,069	-8,778	0,900	18,684
Capacitive reactive power supply				
Rating power [%]	Active power [kW]	Reactive power [kVar]	Power factor [cos φ]	DC power [kW]
10%	1,861	8,723	0,209	2,046
20%	3,633	8,721	0,385	3,844
30%	5,462	8,738	0,530	5,703
40%	7,244	8,732	0,638	7,519
50%	9,061	8,725	0,720	9,377
60%	10,852	8,719	0,780	11,214
70%	12,657	8,714	0,824	13,070
80%	14,455	8,709	0,857	14,922
90%	16,249	8,706	0,881	16,773
100%	18,086	8,706	0,901	18,685
Cos phi=1 no reactive power supply				
Rating power [%]	Active power [kW]	Reactive power [kVar]	Power factor [cos φ]	DC power [kW]
10%	1,848	0,352	0,982	1,945
20%	3,587	0,362	0,995	3,716
30%	5,396	0,363	0,998	5,564
40%	7,211	0,361	0,999	7,422
50%	9,043	0,363	0,999	9,303
60%	10,858	0,380	0,999	11,172
70%	12,657	0,375	0,999	13,029
80%	14,437	0,387	0,999	14,872
90%	16,170	0,377	0,999	16,670

100%	18,010	0,370	0,999	18,586
------	--------	-------	-------	--------

Assessment criterion:

The power factor resulting in each of the measurement points between 20 % and 90 % of the nominal power is equal to or lower than 0,90 both in over excited and under excited operation,

The test method refer to clause CEI0-21 / EN 50438:2013, Annex D,3,4,2,1,

Generating plants must meet the reactive power requirement regardless of the number of feeding phases under normal steady-state operating conditions in the voltage tolerance band +10%U_n and -15%U_n.

The tests had been performed on the HYD 20KTL-3PH is valid for the HYD 15KTL-3PH, HYD 10KTL-3PH, HYD 8KTL-3PH, HYD 6KTL-3PH and HYD 5KTL-3PH since it is similar in hardware and just power derated by software.

The test results refer to the test report "20TH0332-CEI0-21_0" issued by Bureau Veritas Consumer Products Services Germany GmbH, dated on 2020.05.25.

Diagram

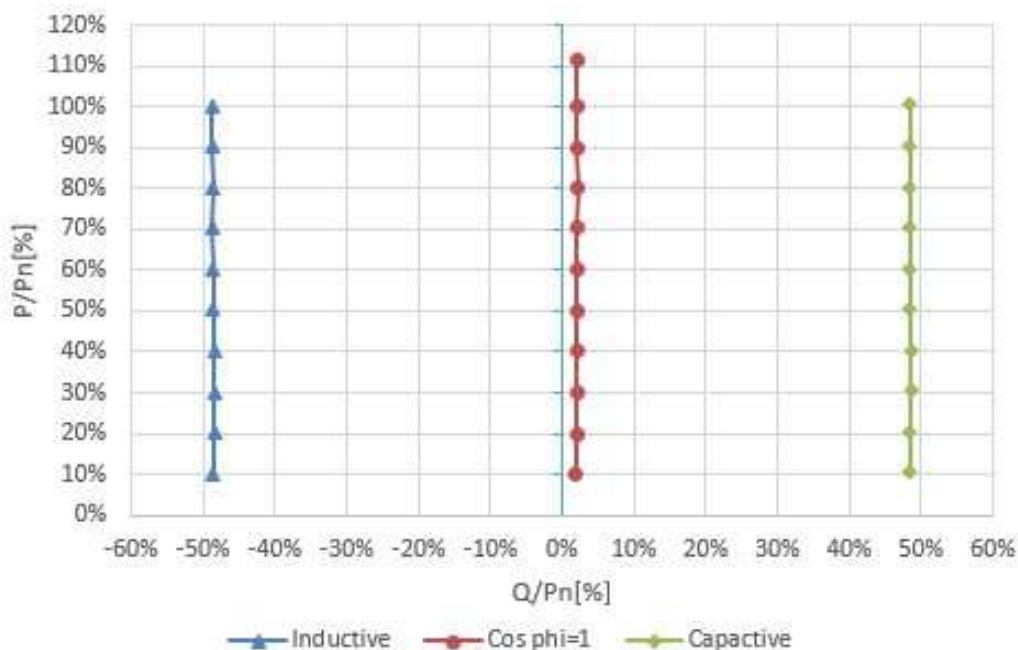

4.7.2.2	Capabilities Q Response time	P
----------------	---	----------

Reaction time

Test result:

		Time	Result
1.	Reaction time Q=0 to Qmin (50% test)	1,2	P
2.	Reaction time Qmin to Qmax (50% test)	1,4	P
3.	Reaction time Qmax to Q=0 (50% test)	0,2	P
4.	Reaction time Q=0 to Qmin (100% test)	1,0	P
5.	Reaction time Qmin to Qmax (100% test)	1,0	P
6.	Reaction time Qmax to Q=0 (100% test)	0,6	P

Test result:

Graph 50%Pn

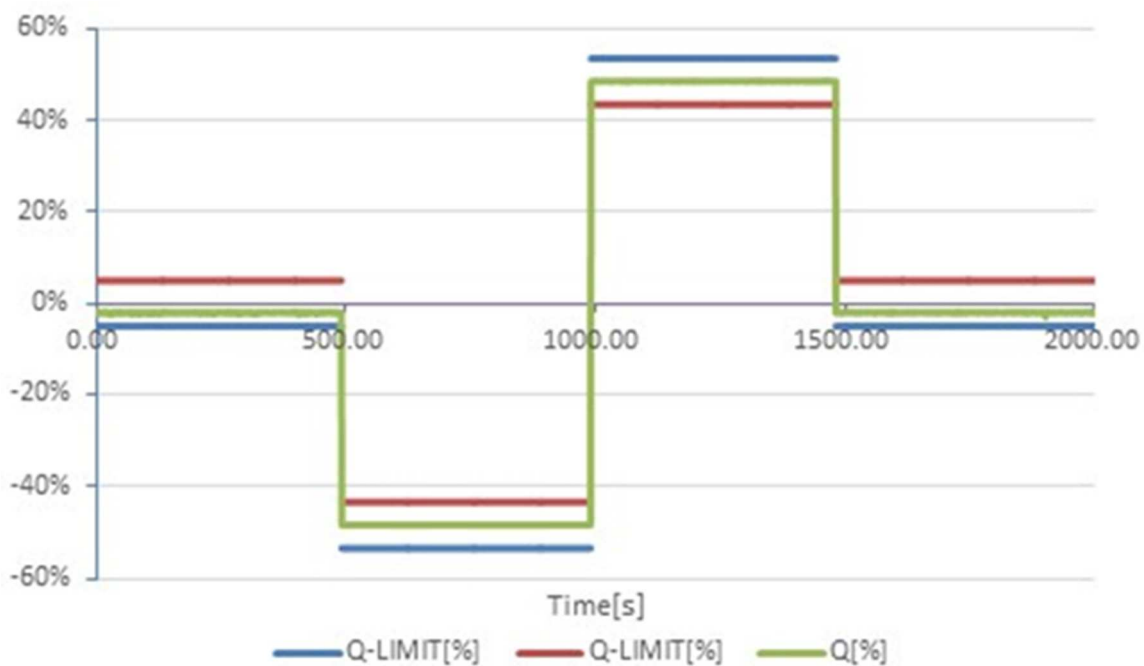

Graph 100%Pn

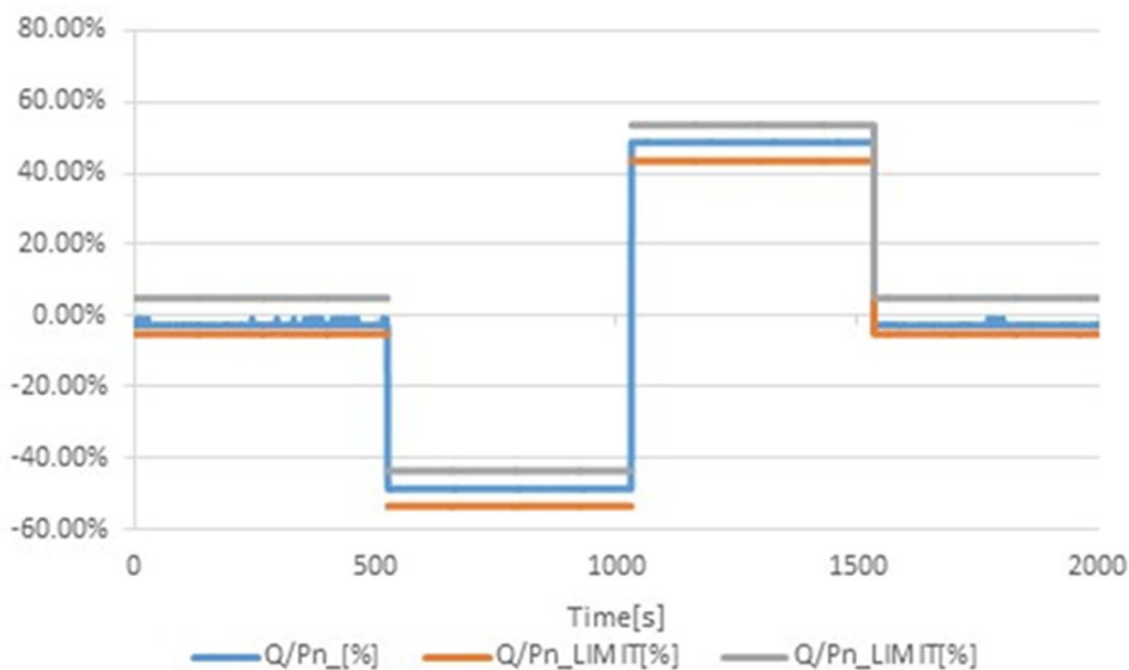

Assessment criterion:

DC source should be set to 50%(test1) and 100%(test2) output power micro-generator.

Starting with Q=0 then $Q_{min} \leq -0,4843 P_n$ to to $Q_{max} \geq 0,4843 P_n$, and then back to Q=0 in doing so each point must be kept for at least 2 minute.

The total tolerance is $\Delta Q \leq \pm 5,0\%$ of P_n or $\Delta \cos\phi \leq \pm 0,01$

The maximum response time is 10s.

The tests had been performed on the HYD 20KTL-3PH is valid for the HYD 15KTL-3PH, HYD 10KTL-3PH, HYD 8KTL-3PH, HYD 6KTL-3PH and HYD 5KTL-3PH since it is similar in hardware and just power derated by software.

The test results refer to the test report "20TH0332-CEI0-21_0" issued by Bureau Veritas Consumer Products Services Germany GmbH, dated on 2020.05.25..

4.7.2.2 Capabilities 4.7.2.3.3 Voltage related control modes (Q (U) controls)							P
The validation of the Q (U) regulation according to VDE-AR-N 4105: 2018-05, 5.7.2.4 is divided into two partial tests, so that on the one hand the accuracy and on the other hand the dynamics of the Q (U) control is checked. For all inverter-coupled systems, only the inverter must be tested.							
Test result:							
Test of the reactive power-voltage characteristic Q (U)							P
Vac [% U _n] Set point	Vac_L1 [V] measured	Vac_L2 [V] measured	Vac_L3 [V] measured	P [kW] measured	Q [kVar] measured	Q [kVar] expected	ΔQ [% P _{Emax}]
100	230,9	230,9	231,0	20,083	0,033	0,000	0,165
99	227,6	227,6	227,7	20,074	0,030	0,000	0,150
98	225,3	225,3	225,4	20,067	0,030	0,000	0,150
97	223,0	223,0	223,1	20,061	0,227	0,000	1,135
96	220,7	220,7	220,8	20,052	2,867	2,963	-0,482
95	218,4	218,5	218,5	20,025	5,251	5,204	0,233
94	216,1	216,2	216,3	19,981	7,572	7,445	0,633
93	213,8	213,9	214,0	19,944	9,953	9,686	1,333
92	211,6	211,6	211,7	19,936	9,957	9,686	1,353
91	209,3	209,3	209,4	19,926	9,959	9,686	1,363
90	207,0	207,0	207,1	19,917	9,951	9,686	1,323
91	209,3	209,3	209,4	19,926	9,960	9,686	1,368
92	211,5	211,6	211,7	19,934	9,955	9,686	1,343
93	213,9	213,9	214,0	19,943	9,946	9,686	1,298
94	216,2	216,2	216,3	19,980	7,569	7,445	0,618
95	218,4	218,5	218,6	20,028	5,233	5,204	0,143
96	220,7	220,8	220,8	20,053	2,883	2,963	-0,402
97	223,0	223,0	223,1	20,063	0,249	0,000	1,245
98	225,3	225,3	225,4	20,070	0,035	0,000	0,175
99	227,6	227,6	227,7	20,077	0,035	0,000	0,175
100	230,4	230,4	230,5	20,084	0,033	0,000	0,165
101	232,2	232,2	232,3	20,088	0,034	0,000	0,170
102	234,5	234,5	234,6	20,094	0,015	0,000	0,075
103	236,7	236,8	236,8	20,100	0,010	0,000	0,050
104	239,0	239,1	239,1	20,100	-2,133	-2,456	1,617

105	241,3	241,4	241,4	20,091	-4,720	-4,866	0,732
106	243,5	243,6	243,7	20,075	-7,285	-7,276	-0,043
107	246,0	246,0	246,1	20,047	-10,043	-9,686	-1,783
108	248,4	248,4	248,5	19,963	-10,272	-9,686	-2,928
109	250,8	250,8	250,9	19,962	-10,272	-9,686	-2,928
110	253,1	253,1	253,2	19,961	-10,272	-9,686	-2,928
109	250,8	250,8	250,9	19,963	-10,273	-9,686	-2,933
108	248,6	248,5	248,6	19,963	-10,271	-9,686	-2,923
107	246,2	246,2	246,3	19,965	-10,272	-9,686	-2,928
106	243,8	243,9	243,9	20,072	-7,561	-7,445	-0,578
105	241,6	241,7	241,7	20,090	-5,056	-5,204	0,742
104	239,3	239,4	239,4	20,100	-2,465	-2,963	2,492
103	237,0	237,0	237,1	20,101	0,112	0,000	0,560
102	234,8	234,8	235,0	20,096	0,127	0,000	0,635
101	232,3	232,3	232,4	20,090	0,118	0,000	0,590
100	230,3	230,4	230,5	20,084	0,136	0,000	0,680

Limit ΔQ :

$\pm 4\% P_{E_{max}}$

Graph of characteristic Q (U):

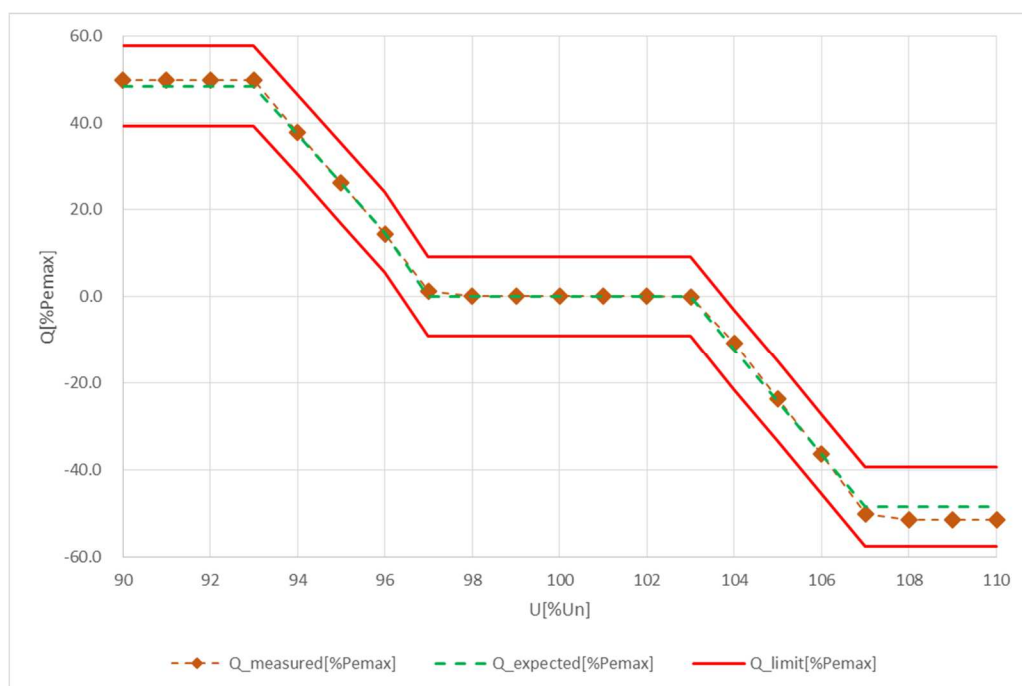

Test:

The verification of the accuracy of the Q (U) control of the reactive power-voltage characteristic U_n shown in VDE-AR-N 4105: 2018-11, 5.7.2.4, Figure 7 is effected by a slow variation of the line voltage U_n in the range 90% U_n to 110% U_n . Depending on the type of EZE (single- or three-phase), the voltage changes must be carried out simultaneously or symmetrically on all phases.

a) In order to check the stationary accuracy, the permissible voltage range shall be passed through within steps, with a step size of 1% U_n , but not greater than 2% U_n .

1. Pass the voltage range from 100% U_n down to the under voltage range to 90% U_n .
2. Pass the voltage range from 90% U_n up to the over voltage range to 110% U_n .
3. Pass the voltage range from 110% U_n down to the Nominal Voltage U_n .

The procedure is analogous to Figure 3 in Section 5.4.3.2.



Bild 7 – Standard-Q(U)-Kennlinie



Bild 3 – Anforderungen an Erzeugungseinheiten bezüglich der Blindleistungsbereitstellung an den Generatorklemmen
($\sum S_{E_{max}} > 4,6 \text{ kVA}$)

The voltages are to be set with a maximum deviation of 0.25% U_n .

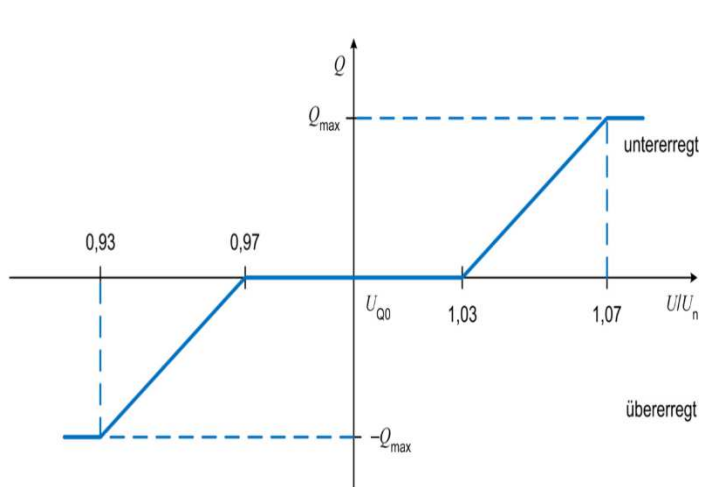
Assessment criterion:

In order to pass the Q (U) accuracy test, the measured stationary value pairs U_{PGU} and Q_{PGU} , under taking account to the correct sign in the consumer metering system, must be within VDE-AR-N 4105: 2018-11, in 5.7.2.4, Figure 7 Q (U) shown characteristic. The stationary value pairs U_{PGU} and Q_{PGU} are determined by averaging over 30 seconds at the end of the respective measuring section analogously to Chapter 5.4.3.2. The permissible deviations are with the maximum measuring error of the voltage of 1% U_n stated in VDE-AR-N 4105: 2018-11 and a setting accuracy of 4% $P_{E_{max}}$ at

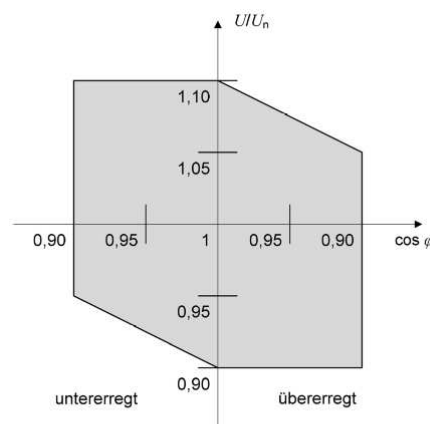
$$Q_{EZE,tol} = \pm(0.01 \cdot U_{N,Y} \cdot k_{QU} + 0.04 \cdot P_{E_{max}}) = \pm 0,25 \cdot P_{E_{max}} \cdot (\sin(\arccos(\varphi_{min})) + 0.16).$$

Note:

The tests had been performed on the HYD 20KTL-3PH is valid for the HYD 15KTL-3PH, HYD 10KTL-3PH, HYD 8KTL-3PH, HYD 6KTL-3PH and HYD 5KTL-3PH since it is similar in hardware and just power derated by software.

The test results refer to the test report "PV200302N015-6" issued by Bureau Veritas Shenzhen Co., Ltd.

Dongguan Branch, dated on 2020.08.21.

Test of the dynamics of the Q (U) regulation				P
Voltage jump Vac [% Un]	Q [kVar] measured	Q [%Qmax] measured	T=3τmeasured	
100 to 106,4	-3,610	-85,633	7,4 s	
	-3,575	-85,110	7,4 s	
	-3,598	-85,771	7,4 s	
100 to 93,6	4,045	84,743	7,4 s	
	4,042	85,012	7,4 s	
	4,049	85,413	7,4 s	

Note:
 The tests had been performed on the HYD 20KTL-3PH is valid for the HYD 15KTL-3PH, HYD 10KTL-3PH, HYD 8KTL-3PH, HYD 6KTL-3PH and HYD 5KTL-3PH since it is similar in hardware and just power derated by software.
 The test results refer to the test report "PV200302N015-6" issued by Bureau Veritas Shenzhen Co., Ltd. Dongguan Branch, dated on 2020.08.21.

Graph of 100%U_n to 106,4% U_n: Test 1

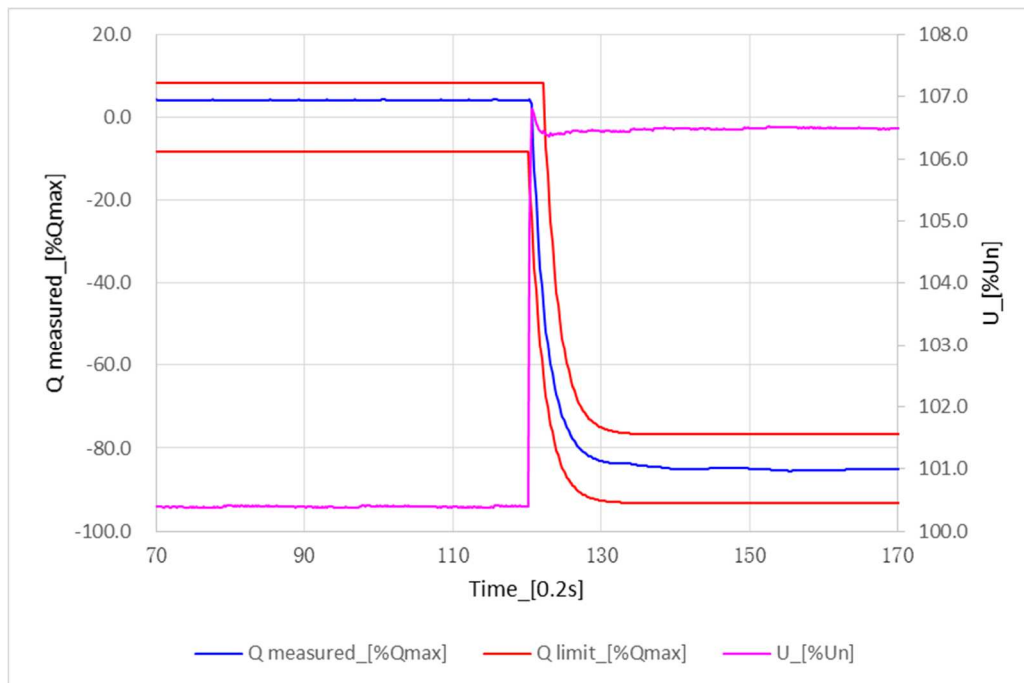

Graph of 100%U_n to 106,4% U_n: Test 2

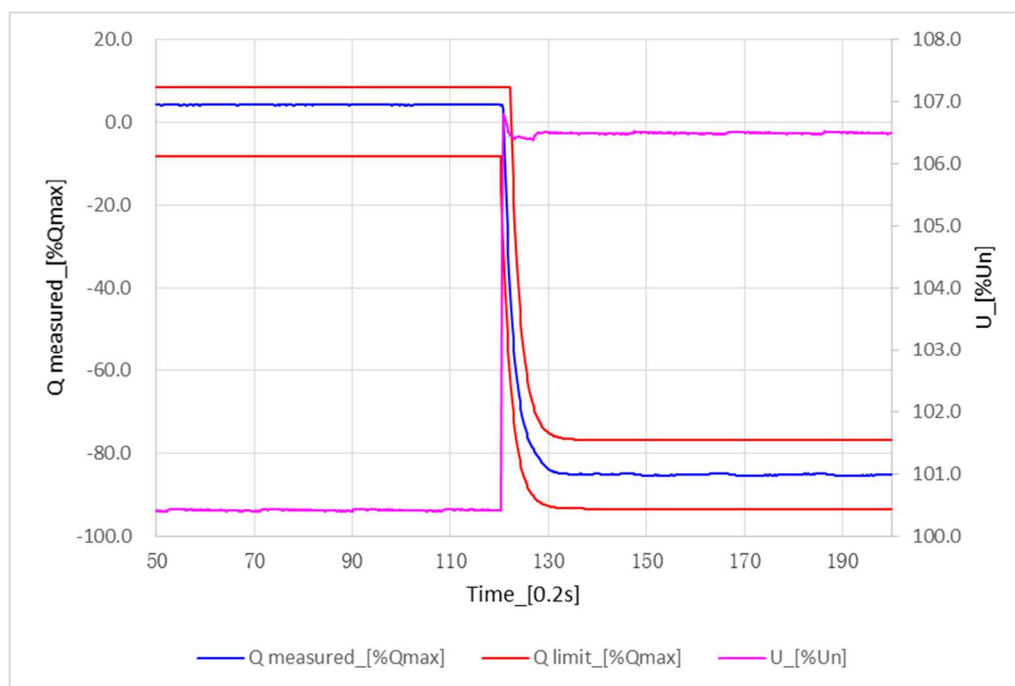

Graph of 100%U_n to 106,4% U_n: Test 3

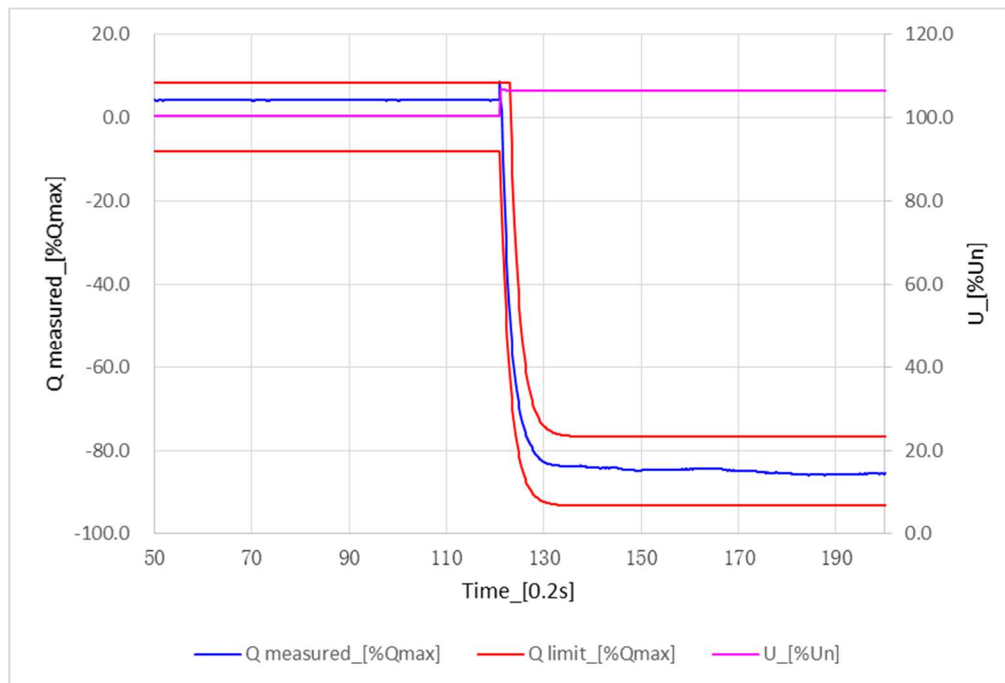

Graph of 100%U_n to 93,6% U_n: Test 1

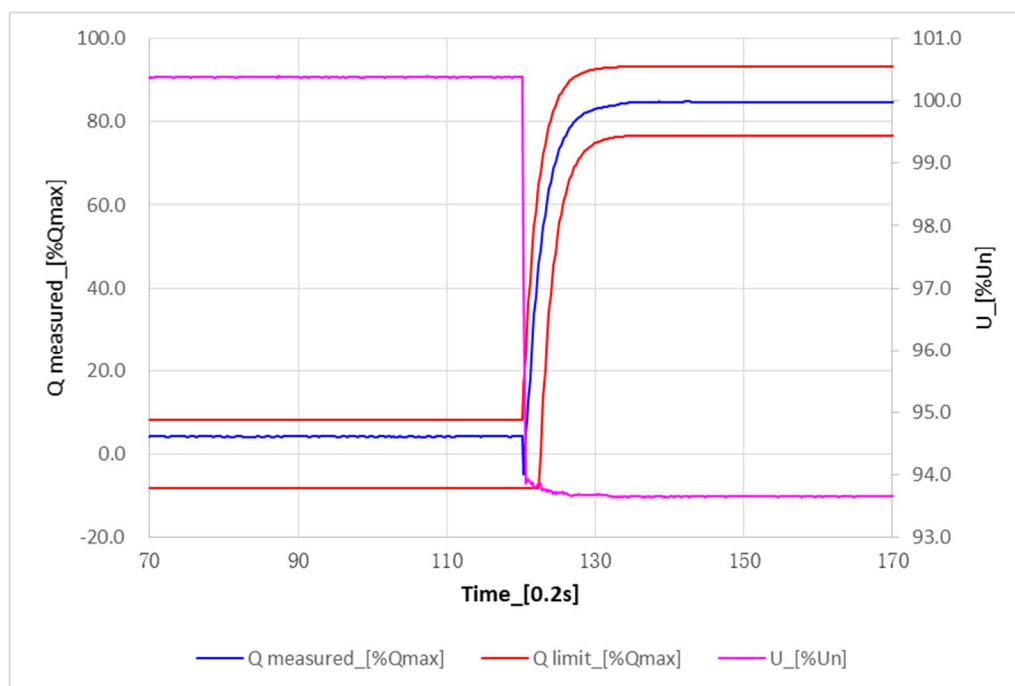

Graph of 100%U_n to 93,6% U_n: Test 2

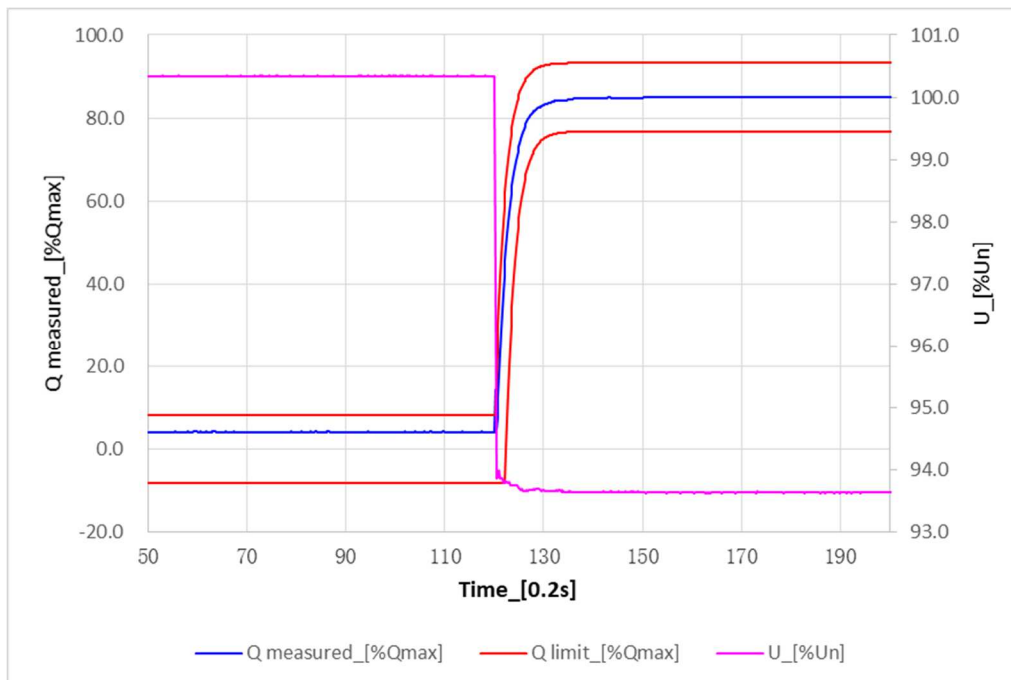

Graph of 100%U_n to 93,6% U_n: Test 3

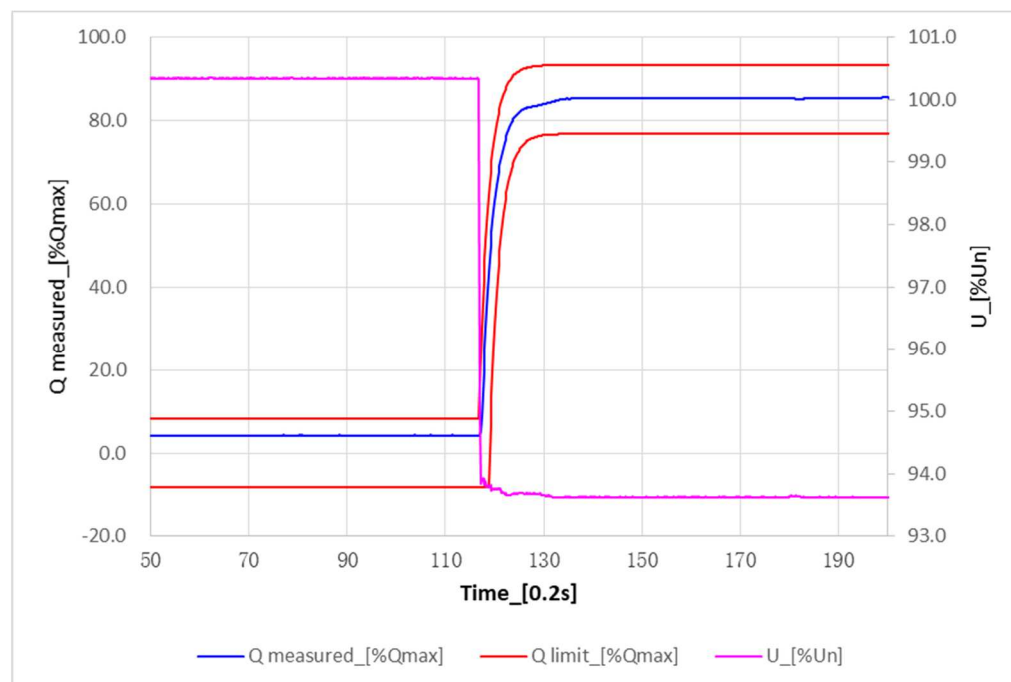

4.7.2.2 Capabilities										P
4.7.2.3.4 Power related Control mode (cos ϕ (P) curve)										
Test result:										
Test c): supply-dependent PGUs - Accuracy (characteristic curve): HYD 20KTL-3PH										
P_{E30}/P [%]	10	20	30	40	50	60	70	80	90	100
30 s mean value	20% to 100% P_{Emax}									
U [V]:	--	230,2	230,3	230,4	230,5	230,4	230,6	230,7	230,7	230,8
P_{E30} [kW]:	--	4,004	6,029	8,053	10,069	12,072	14,069	16,057	18,037	20,008
P_{E30} of P_{Emax} [%]:	--	20,02	30,15	40,27	50,35	60,36	70,35	80,29	90,19	100,04
Q_{E30} [kVar]:	--	-0,004	0,001	0,007	-0,002	-2,449	-4,120	-5,866	-7,745	-9,775
S_{E30} [kVA],	--	4,012	6,035	8,058	10,075	12,318	14,660	17,096	19,630	22,269
cos ϕ_{E30} :	--	0,998	0,999	0,999	0,999	0,980	0,960	0,939	0,919	0,898
cos $\phi_{setpoint}$ of P_{E30} :	--	1,000	1,000	1,000	1,000	0,980	0,960	0,940	0,920	0,900
$Q_{setpoint}$ [kVar]:	--	0,000	0,000	0,000	0,000	-2,451	-4,105	-5,833	-7,693	-9,707
$\Delta Q/P_{Emax}$ [%]	--	-0,020	0,005	0,035	-0,010	0,010	-0,075	-0,165	-0,260	-0,340
Limit ΔQ:	$\pm 4\% P_{Emax}$									
P_{Emax}/P [%]	100	90	80	70	60	50	40	30	20	10
30 s mean value	100% to 20% P_{Emax}									
U [V]:	230,8	230,8	230,7	230,6	230,5	230,5	230,3	230,2	230,1	--
P_{E30} [kW]:	20,007	18,035	16,054	14,066	12,070	10,068	8,051	6,028	4,004	--
P_{E30} of P_{Emax} [%]:	100,04	90,18	80,27	70,33	60,35	50,34	40,26	30,14	20,02	--
Q_{E30} [kVar]:	-9,775	-7,741	-5,863	-4,116	-2,445	0,002	0,019	0,010	0,000	--
S_{E30} [kVA],	22,268	19,627	17,092	14,657	12,315	10,073	8,057	6,034	4,011	--
cos ϕ_{E30} :	0,898	0,919	0,939	0,960	0,980	0,999	0,999	0,999	0,998	--
cos $\phi_{setpoint}$ of P_{E30} :	0,900	0,920	0,940	0,960	0,980	1,000	1,000	1,000	1,000	--
$Q_{setpoint}$ [kVar]:	-9,706	-7,692	-5,831	-4,104	-2,451	0,000	0,000	0,000	0,000	--
$\Delta Q/P_{Emax}$ [%]	-0,345	-0,245	-0,160	-0,060	0,030	0,010	0,095	0,050	0,000	--
Limit ΔQ:	$\pm 4\% P_{Emax}$									
Test d): supply-dependent PGUs - Dynamic: HYD 20KTL-3PH										
P_{Emax}/P_n [%]	100		40			100		75		
30 s mean value	100% to 40% to 100% to 75% P_{Emax}									
U [V]:	230,7		230,4			230,7		230,6		
P_{E30} [kW]:	20,008		8,048			20,010		15,040		
P_{E30} of P_{Emax} [%]:	100,04		40,24			100,05		75,20		
Q_{E30} [kVar]:	-9,919		-0,164			-9,920		-5,103		



S_{E30} [kVA] ,	22,332	8,051	22,334	15,882
$\cos \varphi_{E30}$:	0,896	0,999	0,896	0,947
$\cos \varphi_{\text{setpoint of } P_{E30}}$:	0,900	1,000	0,900	0,950
Q_{setpoint} [kVar]:	-9,917	0,000	-9,918	-5,102
$\Delta Q/P_{E\text{max}}$ [%]	-0,012	-0,820	-0,012	-0,006
Limit ΔQ:	$\pm 4\% P_{E\text{max}}$			

Graph of $\cos \varphi(P)$: Test c)

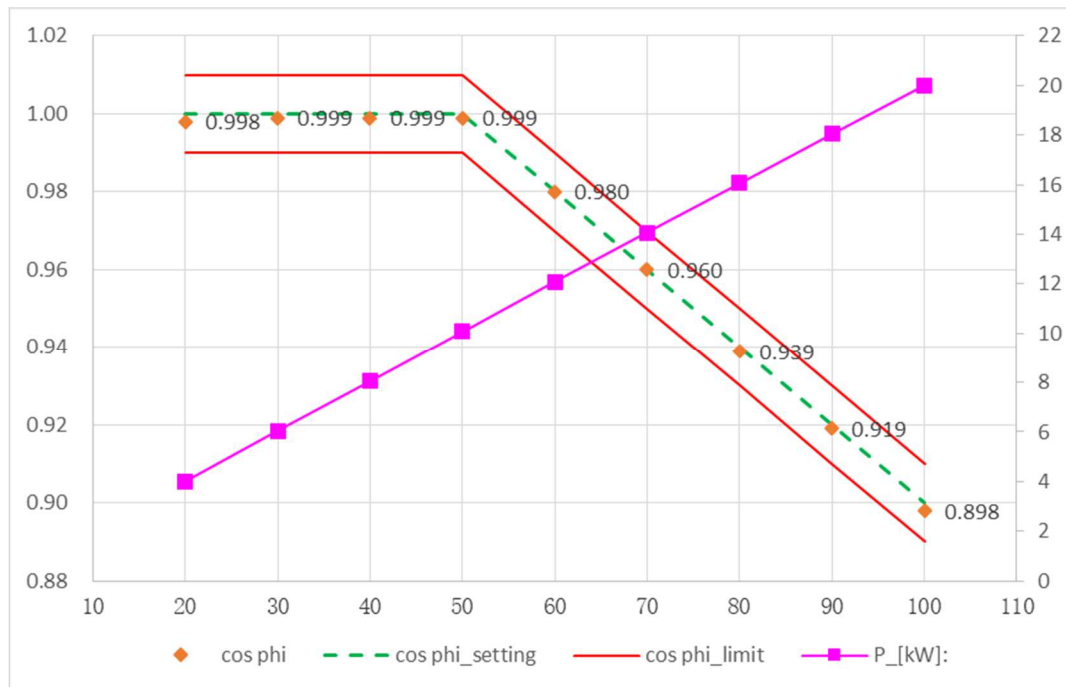

Graph of Test d): 100% to 40% $P_{E_{max}}$

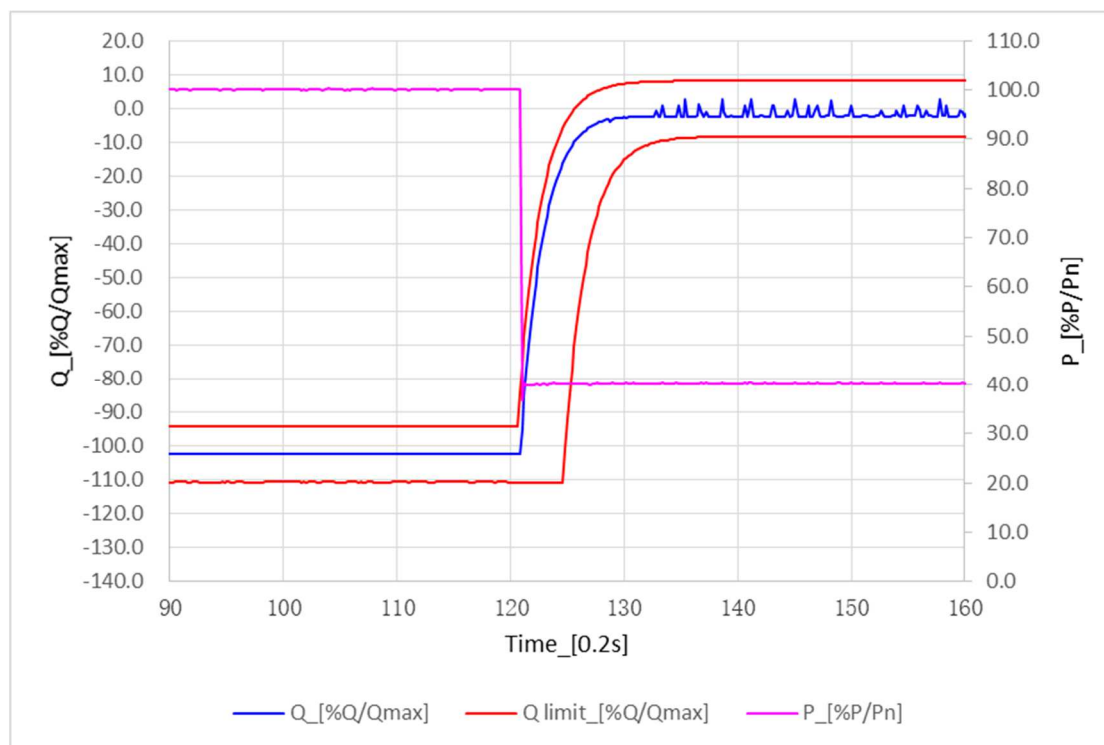

Graph of Test d): 40% to 100% P_Emax

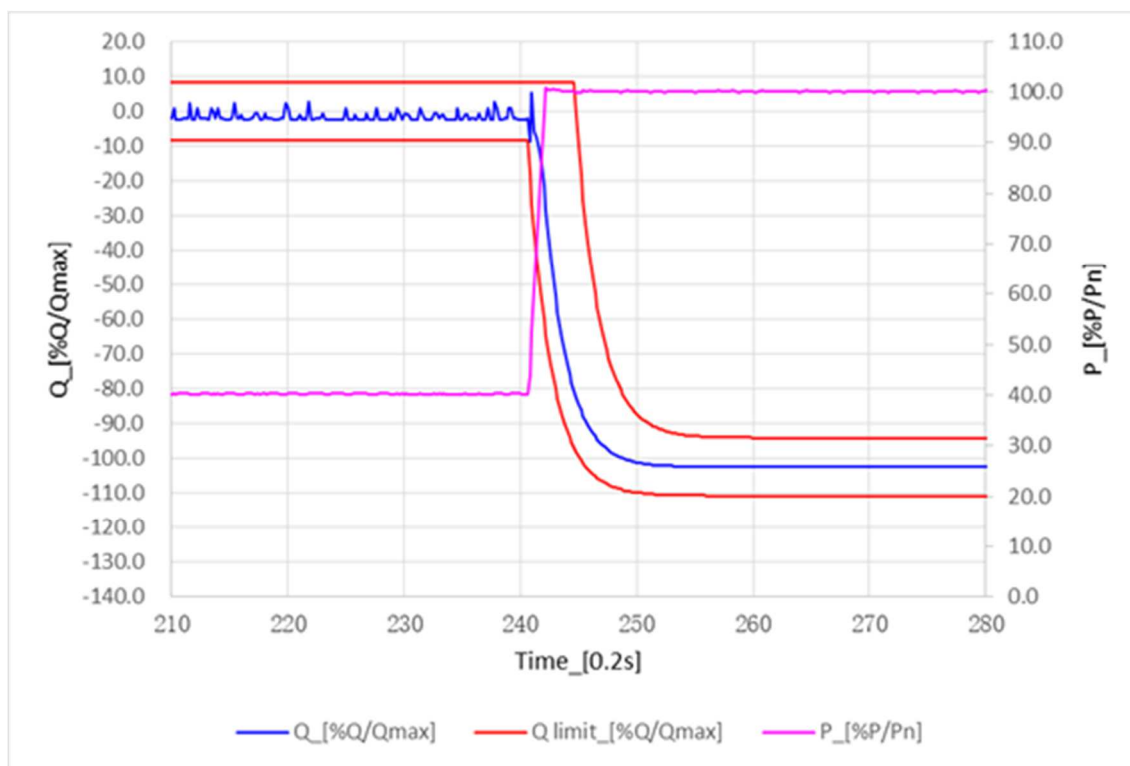

Graph of Test d): 100% to 75% P_Emax

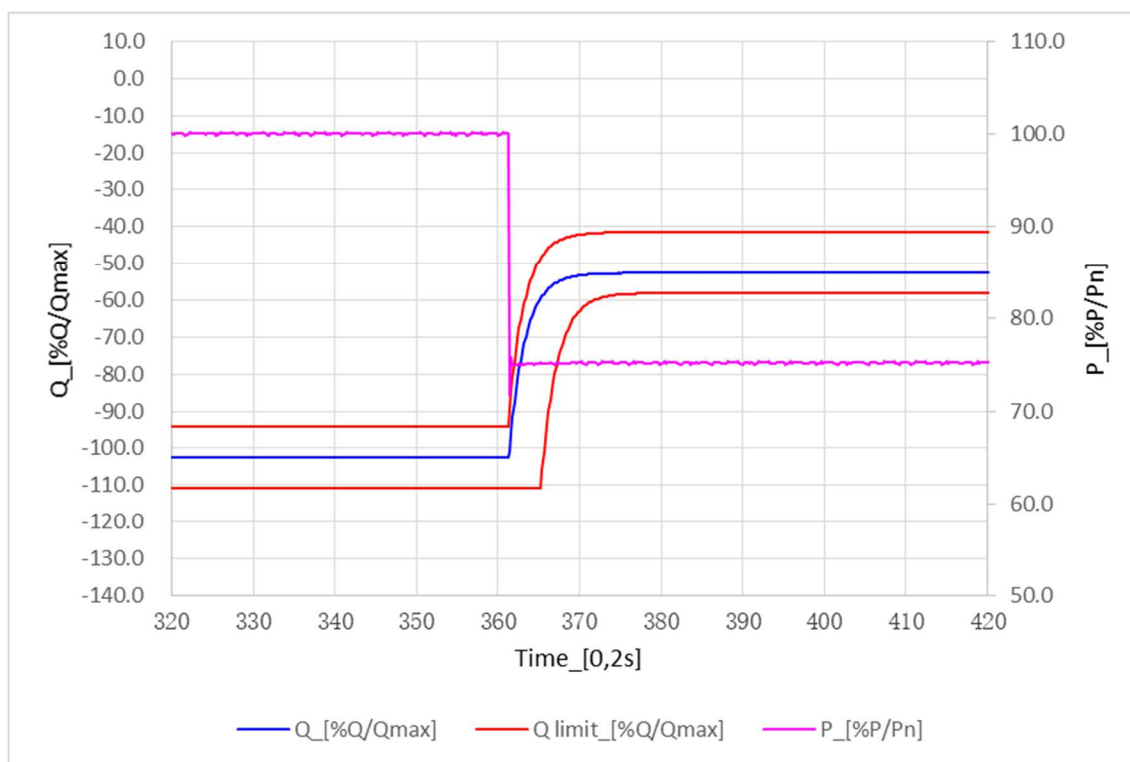

Assessment criterion:

Test 5.4.8.2 a) and c) are passed if the maximum deviation between the reactive power setpoint (calculated from the characteristic) and the reactive power actual value at the generator terminals for all calculated reactive power values is a maximum of $\pm 4.0\%$ relative to $P_{E_{max}}$.

Test 5.4.8.2 (b) is regarded as passed if the PGU demonstrably complies with the performance gradient requirements of VDE-AR-N 4105: 2018-11 in Section 5.7.4.2.

Test 5.4.8.2 d) is passed if the step response of the reactive power in the test steps c) and e) exhibits the PT1 behavior according to VDE-AR-N 4105: 2018-11 Section 5.7.2.5 and for test step d) the power gradient between the Limits of VDE-AR-N 4105: 2018-11 Section 5.7.4.2.

Note:

The tests had been performed on the HYD 20KTL-3PH is valid for the HYD 15KTL-3PH, HYD 10KTL-3PH, HYD 8KTL-3PH, HYD 6KTL-3PH and HYD 5KTL-3PH since it is similar in hardware and just power derated by software.

The test results refer to the test report "PV200302N015-6" issued by Bureau Veritas Shenzhen Co., Ltd. Dongguan Branch, dated on 2020.08.21.

4.7.3	Voltage related active power reduction (P(U) function)	P
--------------	---	----------

Test:

5-min mean value / P / P _n [%]	100% to 20%
Settling time [s]:	271s
P _{E60} [%]:	18,34 %
ΔP _{E60} /P _{Setpoint} [%]:	20 % or less of P _{E_{max}}
Limit settling time:	600s

Test:

- Set the voltage to 2% V_n lower than the activation threshold stated by the manufacturer.
- Set the voltage to 112%V_n, The inverter now has to reduce its output power to value lower than 20%P_n within 5min.
- Set the voltage back to 2%V_n lower than the activation threshold, Check that the active power will return to the value consistent with the power available from the primary source or simulated.

The tests had been performed on the HYD 20KTL-3PH is valid for the HYD 15KTL-3PH, HYD 10KTL-3PH, HYD 8KTL-3PH, HYD 6KTL-3PH and HYD 5KTL-3PH since it is similar in hardware and just power derated by software.

The test results refer to the test report "20TH0332-CE10-21_0" issued by Bureau Veritas Comsumer Products Services Germany GmbH, dated on 2020.05.25.

Assessment criterion:

for adjustable PGUs:

- no network disconnection
- the active power value does not exceed the setpoint of 20% P_{E_{max}}
- the setting time detemrind is equal or less than 600s

Graph:

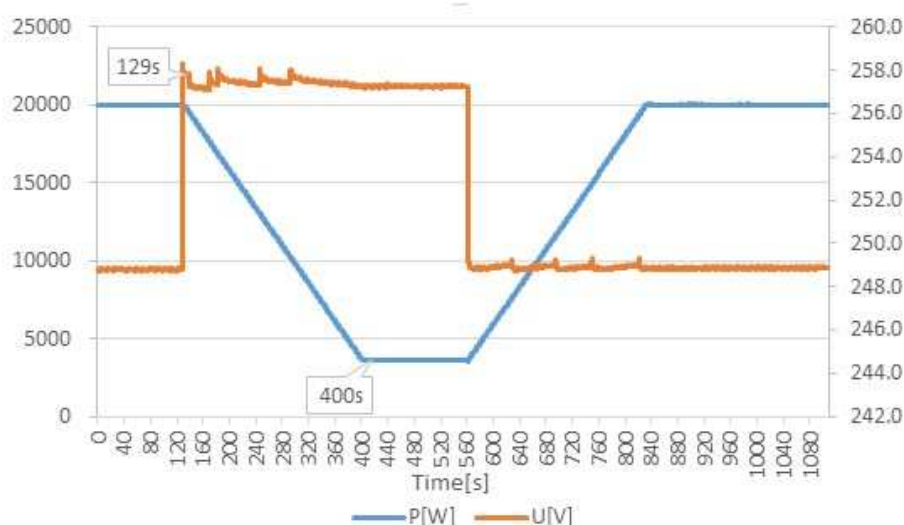

EN 50549-1:2019: Power quality

Clause	Test requirement	Test procedure according standard	Result
4.8	EMC and power quality	--	P
	Harmonic current emission	EN 61000-3-2, EN 61000-3-12	P
	Harmonic current emission	EN 61000-4-7	P
	Switching operations	IEC 61400-21	P
	Voltage fluctuation and flicker	EN 61000-3-3, EN 61000-3-11	P
	Flicker and voltage fluctuations	IEC 61400-21	P
	DC injection	EN 50438, Annex D,3,10	P
	Immunity to voltage dips and short interruptions	G59/3-4:2018-05, clause 13.8.4.5	P
	Unbalance	BDEW TG3, Revision 25, clause 4.3.5	P

4.8 EMC and power quality Harmonic current emission (EN 61000-3-2)								P
Test result: HYD 5KTL-3PH								
Watts [KW]				1,679		1,680		1,678
Vrms [V]				230,31		230,30		230,38
Arms [A]				7,290		7,297		7,285
Frequency [Hz]				50				
THD50* (100% output power)				0,694		0,675		0,691
Harmonic order n	Current Magnitude [A] at 100% rated output power			% of Fundamental			Phase	Harmonic Current Limits [A]
Phase	Phase L1	Phase L2	Phase L3	Phase L1	Phase L2	Phase L3	--	--
1st	7,290	7,297	7,285	100,601	100,693	100,532	Three Phase	--
2nd	0,008	0,007	0,004	0,111	0,099	0,050	Three Phase	1,080
3rd	0,004	0,005	0,005	0,052	0,069	0,069	Three Phase	2,300
4th	0,005	0,004	0,004	0,063	0,060	0,049	Three Phase	0,430
5th	0,015	0,015	0,015	0,213	0,204	0,204	Three Phase	1,140
6th	0,008	0,005	0,005	0,114	0,066	0,069	Three Phase	0,300
7th	0,005	0,005	0,006	0,072	0,069	0,080	Three Phase	0,770
8th	0,003	0,003	0,003	0,039	0,041	0,039	Three Phase	0,230
9th	0,003	0,003	0,003	0,046	0,035	0,037	Three Phase	0,400
10th	0,002	0,002	0,002	0,031	0,030	0,029	Three Phase	0,184
11th	0,012	0,012	0,012	0,170	0,169	0,167	Three Phase	0,330
12th	0,004	0,002	0,003	0,057	0,027	0,041	Three Phase	0,153
13th	0,011	0,011	0,011	0,146	0,158	0,155	Three Phase	0,210
14th	0,001	0,001	0,002	0,020	0,020	0,023	Three Phase	0,131
15th	0,003	0,002	0,002	0,039	0,027	0,034	Three Phase	0,150
16th	0,002	0,002	0,002	0,027	0,028	0,028	Three Phase	0,115
17th	0,008	0,008	0,008	0,108	0,109	0,110	Three Phase	0,132
18th	0,002	0,001	0,001	0,024	0,014	0,020	Three Phase	0,102
19th	0,020	0,020	0,020	0,280	0,274	0,279	Three Phase	0,118
20th	0,001	0,001	0,001	0,018	0,016	0,016	Three Phase	0,092
21th	0,002	0,001	0,004	0,032	0,020	0,048	Three Phase	0,107
22th	0,003	0,003	0,003	0,042	0,039	0,041	Three Phase	0,084
23th	0,007	0,006	0,007	0,099	0,089	0,098	Three Phase	0,098
24th	0,001	0,001	0,001	0,014	0,016	0,019	Three Phase	0,077
25th	0,024	0,023	0,024	0,335	0,320	0,325	Three Phase	0,090
26th	0,001	0,001	0,001	0,017	0,016	0,016	Three Phase	0,071
27th	0,003	0,002	0,004	0,042	0,034	0,052	Three Phase	0,083
28th	0,004	0,004	0,004	0,052	0,053	0,057	Three Phase	0,066
29th	0,012	0,013	0,015	0,166	0,183	0,207	Three Phase	0,078
30th	0,002	0,002	0,002	0,025	0,024	0,027	Three Phase	0,061
31th	0,010	0,009	0,011	0,134	0,128	0,155	Three Phase	0,073
32th	0,003	0,003	0,003	0,046	0,046	0,041	Three Phase	0,058
33th	0,004	0,004	0,005	0,051	0,049	0,072	Three Phase	0,680
34th	0,003	0,003	0,004	0,044	0,047	0,053	Three Phase	0,054
35th	0,016	0,016	0,016	0,226	0,218	0,218	Three Phase	0,064
36th	0,001	0,001	0,001	0,016	0,015	0,015	Three Phase	0,051
37th	0,007	0,008	0,007	0,102	0,111	0,097	Three Phase	0,061
38th	0,003	0,003	0,004	0,046	0,048	0,050	Three Phase	0,048
39th	0,002	0,002	0,002	0,022	0,028	0,033	Three Phase	0,058

40th	0,002	0,003	0,002	0,031	0,035	0,034	Three Phase	0,046
------	-------	-------	-------	-------	-------	-------	-------------	-------

Test result: HYD 10KTL-3PH								
Watts [KW]				3,371		3,365		3,379
Vrms [V]				230,470		230,492		230,487
Arms [A]				14,633		14,608		14,672
Frequency [Hz]				50				
THD50* (100% output power)				1,557		1,397		1,100
Harmonic order n	Current Magnitude [A] at 100% rated output power			% of Fundamental			Phase	Harmonic Current Limits [A]
	Phase L1	Phase L2	Phase L3	Phase L1	Phase L2	Phase L3		
Phase	Phase L1	Phase L2	Phase L3	Phase L1	Phase L2	Phase L3	--	--
1st	14,629	14,604	14,668	100,943	100,765	101,206	Three Phase	--
2nd	0,059	0,070	0,022	0,404	0,481	0,155	Three Phase	1,080
3rd	0,039	0,063	0,019	0,270	0,438	0,132	Three Phase	2,300
4th	0,044	0,051	0,012	0,304	0,352	0,084	Three Phase	0,430
5th	0,128	0,108	0,086	0,881	0,743	0,592	Three Phase	1,140
6th	0,037	0,040	0,020	0,256	0,274	0,138	Three Phase	0,300
7th	0,049	0,049	0,049	0,338	0,339	0,341	Three Phase	0,770
8th	0,030	0,027	0,006	0,204	0,189	0,042	Three Phase	0,230
9th	0,014	0,006	0,007	0,094	0,041	0,049	Three Phase	0,400
10th	0,013	0,013	0,005	0,086	0,092	0,037	Three Phase	0,184
11th	0,021	0,018	0,021	0,142	0,121	0,147	Three Phase	0,330
12th	0,009	0,006	0,005	0,061	0,045	0,034	Three Phase	0,153
13th	0,034	0,035	0,033	0,234	0,245	0,224	Three Phase	0,210
14th	0,005	0,004	0,002	0,036	0,029	0,015	Three Phase	0,131
15th	0,019	0,011	0,009	0,133	0,078	0,064	Three Phase	0,150
16th	0,003	0,002	0,002	0,023	0,013	0,014	Three Phase	0,115
17th	0,029	0,028	0,033	0,201	0,192	0,225	Three Phase	0,132
18th	0,004	0,003	0,002	0,028	0,022	0,013	Three Phase	0,102
19th	0,009	0,010	0,011	0,065	0,070	0,079	Three Phase	0,118
20th	0,003	0,002	0,002	0,021	0,013	0,012	Three Phase	0,092
21th	0,014	0,010	0,009	0,094	0,070	0,065	Three Phase	0,107
22th	0,002	0,001	0,002	0,013	0,009	0,010	Three Phase	0,084
23th	0,012	0,010	0,011	0,080	0,069	0,078	Three Phase	0,098
24th	0,003	0,001	0,002	0,020	0,009	0,014	Three Phase	0,077
25th	0,049	0,053	0,047	0,338	0,362	0,328	Three Phase	0,090
26th	0,002	0,001	0,002	0,011	0,008	0,012	Three Phase	0,071
27th	0,040	0,026	0,028	0,278	0,178	0,190	Three Phase	0,083
28th	0,003	0,003	0,003	0,022	0,020	0,024	Three Phase	0,066
29th	0,084	0,035	0,064	0,583	0,241	0,440	Three Phase	0,078
30th	0,003	0,002	0,006	0,021	0,013	0,039	Three Phase	0,061
31th	0,076	0,051	0,042	0,526	0,351	0,289	Three Phase	0,073
32th	0,005	0,003	0,005	0,038	0,023	0,035	Three Phase	0,058
33th	0,027	0,041	0,026	0,185	0,282	0,176	Three Phase	0,680
34th	0,003	0,004	0,004	0,020	0,030	0,026	Three Phase	0,054
35th	0,039	0,033	0,037	0,272	0,228	0,255	Three Phase	0,064
36th	0,002	0,001	0,002	0,011	0,008	0,011	Three Phase	0,051
37th	0,002	0,003	0,003	0,015	0,020	0,021	Three Phase	0,061
38th	0,002	0,001	0,001	0,013	0,009	0,010	Three Phase	0,048
39th	0,009	0,007	0,009	0,064	0,046	0,063	Three Phase	0,058
40th	0,001	0,001	0,001	0,009	0,008	0,008	Three Phase	0,046

Note:

The tests should be based on the limits of the EN 61000-3-2 for less than 16A.

The tests had been performed on the HYD 10KTL-3PH and HYD 5KTL-3PH are valid for the HYD 8KTL-3PH, HYD 6KTL-3PH since it is similar in hardware and just power derated by software.

The test results refer to the test report "PV200302N015-6" issued by Bureau Veritas Shenzhen Co., Ltd. Dongguan Branch, dated on 2020.08.21.

4.8 EMC and power quality Harmonic current emission (EN 61000-3-12)								P
Test result: HYD 20KTL-3PH								
Watts [KW]				6,695		6,704		6,712
Vrms [V]				230,63		230,70		230,79
Arms [A]				29,041		29,068		29,089
Frequency [Hz]				50,00				
THD50* (100% output power)				1,062		1,078		0,786
Harmonic order n	Current Magnitude [A] at 100% rated output power			% of Fundamental			Phase	Harmonic Current Limits [%]
	Phase L1	Phase L2	Phase L3	Phase L1	Phase L2	Phase L3		
Phase	Phase L1	Phase L2	Phase L3	Phase L1	Phase L2	Phase L3	--	--
1st	29,037	29,065	29,087	100,179	100,274	100,351	Three Phase	--
2nd	0,086	0,111	0,077	0,298	0,383	0,266	Three Phase	1
3rd	0,063	0,080	0,018	0,218	0,275	0,064	Three Phase	4
4th	0,020	0,043	0,033	0,069	0,147	0,115	Three Phase	1
5th	0,190	0,183	0,126	0,654	0,630	0,434	Three Phase	4
6th	0,054	0,046	0,021	0,188	0,160	0,073	Three Phase	1
7th	0,065	0,099	0,085	0,224	0,343	0,293	Three Phase	4
8th	0,033	0,027	0,008	0,112	0,092	0,029	Three Phase	1
9th	0,087	0,063	0,024	0,302	0,219	0,083	Three Phase	4
10th	0,015	0,006	0,014	0,053	0,022	0,047	Three Phase	0,5
11th	0,050	0,030	0,048	0,173	0,105	0,165	Three Phase	2
12th	0,024	0,016	0,008	0,082	0,054	0,027	Three Phase	0,5
13th	0,045	0,058	0,050	0,154	0,201	0,173	Three Phase	2
14th	0,011	0,008	0,005	0,040	0,026	0,016	Three Phase	0,5
15th	0,018	0,017	0,003	0,060	0,060	0,011	Three Phase	2
16th	0,011	0,012	0,002	0,037	0,041	0,008	Three Phase	0,5
17th	0,058	0,045	0,053	0,200	0,156	0,184	Three Phase	1,5
18th	0,015	0,005	0,009	0,051	0,017	0,032	Three Phase	0,5
19th	0,035	0,043	0,041	0,120	0,147	0,141	Three Phase	1,5
20th	0,002	0,003	0,002	0,009	0,011	0,007	Three Phase	0,5
21th	0,042	0,031	0,016	0,146	0,106	0,054	Three Phase	1,5
22th	0,009	0,011	0,003	0,029	0,037	0,009	Three Phase	0,5
23th	0,039	0,043	0,035	0,133	0,150	0,121	Three Phase	0,6
24th	0,007	0,006	0,004	0,025	0,019	0,013	Three Phase	0,5
25th	0,022	0,033	0,038	0,077	0,113	0,133	Three Phase	0,6
26th	0,010	0,007	0,003	0,035	0,025	0,009	Three Phase	0,5
27th	0,045	0,028	0,012	0,154	0,096	0,040	Three Phase	0,6
28th	0,003	0,007	0,003	0,011	0,023	0,011	Three Phase	0,5
29th	0,046	0,039	0,040	0,158	0,134	0,138	Three Phase	0,6
30th	0,006	0,004	0,006	0,021	0,013	0,022	Three Phase	0,5
31th	0,028	0,039	0,034	0,096	0,136	0,118	Three Phase	0,6

32th	0,001	0,001	0,002	0,003	0,005	0,006	Three Phase	0,5
33th	0,035	0,028	0,014	0,121	0,098	0,049	Three Phase	0,6
34th	0,004	0,008	0,005	0,014	0,026	0,016	Three Phase	--
35th	0,039	0,041	0,021	0,136	0,140	0,073	Three Phase	--
36th	0,004	0,004	0,006	0,013	0,015	0,020	Three Phase	--
37th	0,064	0,068	0,060	0,223	0,236	0,206	Three Phase	--
38th	0,003	0,004	0,001	0,011	0,013	0,004	Three Phase	--
39th	0,070	0,057	0,029	0,241	0,198	0,101	Three Phase	--
40th	0,001	0,006	0,005	0,003	0,019	0,016	Three Phase	--

Note:

The tests should be based on the limits of the EN 61000-3-12 for more than 16A.

The tests had been performed on the HYD 20KTL-3PH is valid for the HYD 15KTL-3PH since it is similar in hardware and just power derated by software.

The test results refer to the test report "PV200302N015-6" issued by Bureau Veritas Shenzhen Co., Ltd. Dongguan Branch, dated on 2020.08.21.

4.8 EMC and power quality Harmonic current emission (EN 61000-4-7)											P
The currents of the interharmonics to 2 kHz must be measured in accordance with DIN EN 61000-4-7 (VDE 0817-4-7), Annex A, The measurements of higher-frequency harmonic currents between 2 kHz and 9 kHz must be conducted in line with DIN EN 61000-4-7 (VDE 0847-4-7), Annex B.											
Test result: HYD 5KTL-3PH											
Harmonics											
P/P _n [%]	0	10	20	30	40	50	60	70	80	90	100
Order	I [%]	I [%]	I [%]	I [%]	I [%]	I [%]	I [%]	I [%]	I [%]	I [%]	I [%]
1	2,214	9,427	19,473	29,632	39,781	49,953	60,130	70,276	80,405	90,599	100,688
2	0,181	0,276	0,253	0,231	0,219	0,168	0,154	0,180	0,177	0,137	0,155
3	0,102	0,199	0,258	0,201	0,148	0,146	0,188	0,196	0,234	0,234	0,221
4	0,113	0,294	0,255	0,215	0,187	0,129	0,113	0,127	0,124	0,101	0,116
5	0,567	1,248	1,233	0,663	0,512	0,627	0,765	0,840	0,833	0,848	0,840
6	0,082	0,187	0,163	0,150	0,141	0,113	0,121	0,135	0,132	0,110	0,125
7	0,794	0,896	1,245	0,829	0,434	0,209	0,225	0,370	0,384	0,265	0,340
8	0,190	0,240	0,184	0,158	0,126	0,089	0,099	0,107	0,119	0,103	0,109
9	0,098	0,160	0,202	0,240	0,230	0,192	0,216	0,257	0,235	0,238	0,214
10	0,136	0,217	0,143	0,152	0,122	0,097	0,104	0,103	0,100	0,086	0,095
11	0,596	0,884	0,831	1,518	1,216	0,550	0,318	0,463	0,608	0,719	0,755
12	0,085	0,145	0,125	0,122	0,109	0,079	0,080	0,083	0,074	0,076	0,075
13	0,398	0,584	0,845	0,848	0,534	0,428	0,542	0,693	0,707	0,664	0,577
14	0,327	0,307	0,140	0,116	0,107	0,085	0,081	0,086	0,076	0,068	0,072
15	0,097	0,113	0,189	0,123	0,103	0,129	0,126	0,136	0,186	0,206	0,186
16	0,239	0,200	0,202	0,098	0,094	0,080	0,075	0,074	0,074	0,074	0,068
17	0,304	0,284	0,826	0,613	0,917	0,967	0,652	0,521	0,292	0,136	0,294
18	0,062	0,126	0,118	0,090	0,083	0,057	0,060	0,056	0,053	0,052	0,048
19	0,564	0,512	0,835	0,825	1,080	0,588	0,298	0,460	0,707	0,913	0,988
20	0,258	0,352	0,125	0,079	0,082	0,073	0,058	0,060	0,055	0,049	0,054
21	0,068	0,086	0,105	0,111	0,085	0,102	0,131	0,112	0,109	0,120	0,133
22	0,115	0,162	0,104	0,119	0,061	0,068	0,073	0,063	0,057	0,051	0,053
23	0,451	0,202	0,394	0,583	0,773	0,522	0,405	0,349	0,252	0,243	0,289
24	0,050	0,097	0,083	0,071	0,059	0,050	0,045	0,044	0,040	0,041	0,037
25	0,326	0,258	0,225	0,665	0,704	0,742	0,505	0,377	0,320	0,466	0,592
26	0,252	0,228	0,072	0,130	0,083	0,063	0,044	0,049	0,051	0,043	0,039
27	0,055	0,087	0,069	0,076	0,075	0,064	0,049	0,067	0,069	0,070	0,076
28	0,149	0,195	0,134	0,106	0,059	0,039	0,037	0,043	0,044	0,040	0,042
29	0,331	0,256	0,559	0,500	0,173	0,679	0,578	0,236	0,142	0,156	0,178
30	0,060	0,100	0,093	0,062	0,050	0,037	0,037	0,039	0,034	0,035	0,037
31	0,234	0,157	0,356	0,395	0,167	0,528	0,387	0,236	0,214	0,220	0,159
32	0,323	0,162	0,147	0,135	0,093	0,097	0,075	0,058	0,051	0,046	0,036
33	0,058	0,093	0,088	0,101	0,082	0,089	0,077	0,083	0,095	0,110	0,090
34	0,251	0,205	0,161	0,122	0,061	0,051	0,052	0,051	0,040	0,046	0,042
35	0,126	0,191	0,175	0,233	0,230	0,203	0,203	0,410	0,392	0,296	0,189
36	0,065	0,111	0,097	0,055	0,056	0,040	0,048	0,045	0,037	0,037	0,041

37	0,164	0,164	0,120	0,290	0,166	0,207	0,235	0,372	0,242	0,096	0,196
38	0,143	0,289	0,132	0,067	0,055	0,051	0,054	0,045	0,039	0,040	0,036
39	0,067	0,068	0,048	0,043	0,075	0,109	0,105	0,077	0,089	0,108	0,125
40	0,340	0,315	0,261	0,142	0,104	0,067	0,065	0,046	0,038	0,040	0,036

Interharmonics: HYD 5KTL-3PH

P/P _n [%]	0	10	20	30	40	50	60	70	80	90	100
f [Hz]	I [%]	I [%]	I [%]	I [%]	I [%]	I [%]	I [%]	I [%]	I [%]	I [%]	I [%]
75	0,055	0,352	0,319	0,311	0,322	0,203	0,195	0,296	0,309	0,193	0,256
125	0,061	0,163	0,135	0,136	0,138	0,099	0,099	0,111	0,121	0,093	0,112
175	0,065	0,163	0,140	0,142	0,141	0,111	0,111	0,124	0,129	0,113	0,128
225	0,070	0,338	0,284	0,243	0,187	0,130	0,132	0,147	0,148	0,132	0,147
275	0,079	0,369	0,301	0,259	0,199	0,139	0,139	0,152	0,157	0,145	0,155
325	0,074	0,325	0,271	0,244	0,212	0,145	0,145	0,161	0,162	0,143	0,154
375	0,077	0,360	0,299	0,231	0,179	0,126	0,131	0,160	0,173	0,145	0,157
425	0,068	0,169	0,138	0,140	0,132	0,111	0,115	0,119	0,121	0,116	0,117
475	0,060	0,142	0,117	0,124	0,119	0,099	0,104	0,107	0,103	0,099	0,101
525	0,059	0,275	0,233	0,177	0,150	0,103	0,096	0,101	0,093	0,087	0,089
575	0,062	0,289	0,235	0,194	0,171	0,103	0,088	0,095	0,083	0,078	0,083
625	0,052	0,211	0,212	0,157	0,140	0,093	0,082	0,089	0,080	0,072	0,077
675	0,053	0,215	0,230	0,162	0,153	0,097	0,078	0,082	0,074	0,064	0,070
725	0,045	0,112	0,103	0,088	0,088	0,073	0,065	0,065	0,064	0,060	0,061
775	0,042	0,096	0,090	0,082	0,081	0,067	0,059	0,061	0,062	0,059	0,058
825	0,041	0,176	0,170	0,135	0,115	0,069	0,056	0,063	0,066	0,058	0,059
875	0,042	0,160	0,183	0,130	0,109	0,072	0,059	0,065	0,059	0,056	0,053
925	0,042	0,142	0,150	0,131	0,104	0,067	0,056	0,060	0,057	0,053	0,053
975	0,039	0,137	0,154	0,121	0,096	0,063	0,055	0,057	0,051	0,045	0,048
1025	0,040	0,077	0,077	0,071	0,073	0,055	0,053	0,053	0,048	0,044	0,050
1075	0,034	0,074	0,061	0,064	0,058	0,060	0,051	0,048	0,044	0,049	0,050
1125	0,035	0,112	0,113	0,100	0,089	0,060	0,058	0,056	0,055	0,043	0,048
1175	0,035	0,101	0,115	0,106	0,083	0,055	0,050	0,053	0,049	0,042	0,043
1225	0,047	0,101	0,118	0,115	0,100	0,075	0,068	0,062	0,057	0,046	0,041
1275	0,035	0,089	0,108	0,097	0,077	0,053	0,041	0,043	0,042	0,040	0,043
1325	0,040	0,062	0,063	0,058	0,052	0,046	0,042	0,044	0,044	0,042	0,041
1375	0,032	0,057	0,053	0,052	0,046	0,040	0,036	0,038	0,039	0,037	0,036
1425	0,039	0,086	0,096	0,085	0,069	0,051	0,045	0,047	0,046	0,042	0,043
1475	0,032	0,078	0,096	0,081	0,067	0,044	0,039	0,045	0,044	0,037	0,038
1525	0,031	0,076	0,088	0,075	0,062	0,043	0,040	0,042	0,043	0,038	0,040
1575	0,032	0,073	0,089	0,071	0,057	0,042	0,042	0,046	0,042	0,036	0,039
1625	0,031	0,058	0,050	0,043	0,039	0,037	0,038	0,038	0,037	0,036	0,035
1675	0,031	0,056	0,045	0,040	0,038	0,036	0,038	0,038	0,038	0,036	0,036
1725	0,032	0,074	0,058	0,050	0,044	0,038	0,040	0,040	0,039	0,036	0,036
1775	0,033	0,069	0,056	0,050	0,046	0,037	0,038	0,041	0,040	0,035	0,036
1825	0,033	0,065	0,055	0,053	0,045	0,039	0,039	0,038	0,039	0,036	0,036
1875	0,034	0,066	0,057	0,052	0,046	0,036	0,039	0,040	0,039	0,034	0,034
1925	0,037	0,060	0,042	0,039	0,038	0,036	0,037	0,037	0,037	0,035	0,035
1975	0,036	0,059	0,043	0,040	0,038	0,035	0,037	0,037	0,036	0,035	0,035

Higher Frequencies: HYD 5KTL-3PH											
P/P _n [%]	0	10	20	30	40	50	60	70	80	90	100
f [kHz]	I [%]	I [%]	I [%]	I [%]	I [%]	I [%]	I [%]	I [%]	I [%]	I [%]	I [%]
2,1	0,433	0,320	0,373	0,389	0,444	0,432	0,485	0,650	0,608	0,466	0,369
2,3	0,358	0,358	0,400	0,403	0,442	0,331	0,335	0,280	0,386	0,359	0,326
2,5	0,485	0,383	0,417	0,365	0,342	0,346	0,316	0,414	0,360	0,265	0,280
2,7	0,347	0,341	0,389	0,420	0,427	0,462	0,382	0,313	0,396	0,297	0,273
2,9	0,298	0,320	0,298	0,248	0,368	0,220	0,323	0,254	0,334	0,351	0,254
3,1	0,360	0,280	0,334	0,317	0,297	0,257	0,262	0,236	0,331	0,335	0,246
3,3	0,283	0,283	0,305	0,336	0,288	0,318	0,402	0,329	0,327	0,402	0,327
3,5	0,169	0,217	0,248	0,239	0,238	0,270	0,234	0,286	0,245	0,268	0,281
3,7	0,149	0,171	0,194	0,197	0,195	0,198	0,227	0,209	0,215	0,211	0,207
3,9	0,103	0,114	0,123	0,124	0,127	0,135	0,136	0,149	0,142	0,141	0,142
4,1	0,077	0,090	0,096	0,096	0,100	0,098	0,100	0,103	0,106	0,103	0,104
4,3	0,067	0,076	0,081	0,082	0,083	0,081	0,083	0,086	0,084	0,087	0,087
4,5	0,059	0,064	0,068	0,069	0,070	0,070	0,072	0,071	0,074	0,073	0,074
4,7	0,107	0,113	0,117	0,119	0,120	0,121	0,121	0,122	0,122	0,122	0,123
4,9	0,049	0,052	0,054	0,054	0,055	0,055	0,054	0,056	0,056	0,057	0,057
5,1	0,047	0,049	0,050	0,051	0,051	0,051	0,052	0,052	0,053	0,053	0,053
5,3	0,042	0,044	0,045	0,045	0,045	0,046	0,046	0,046	0,047	0,047	0,047
5,5	0,040	0,042	0,042	0,042	0,042	0,042	0,043	0,043	0,043	0,044	0,044
5,7	0,041	0,042	0,042	0,042	0,043	0,043	0,043	0,043	0,044	0,044	0,044
5,9	0,036	0,038	0,038	0,037	0,038	0,037	0,038	0,038	0,039	0,039	0,039
6,1	0,047	0,048	0,048	0,048	0,048	0,048	0,048	0,049	0,049	0,049	0,049
6,3	0,035	0,035	0,035	0,035	0,035	0,035	0,035	0,036	0,036	0,036	0,037
6,5	0,033	0,034	0,034	0,033	0,034	0,034	0,034	0,034	0,035	0,035	0,035
6,7	0,033	0,034	0,033	0,033	0,033	0,033	0,033	0,034	0,035	0,034	0,035
6,9	0,031	0,033	0,033	0,032	0,033	0,033	0,034	0,034	0,034	0,033	0,035
7,1	0,054	0,055	0,054	0,054	0,054	0,054	0,054	0,054	0,054	0,054	0,055
7,3	0,031	0,032	0,031	0,032	0,032	0,032	0,032	0,032	0,033	0,033	0,033
7,5	0,030	0,031	0,030	0,030	0,031	0,031	0,031	0,031	0,031	0,033	0,032
7,7	0,029	0,030	0,029	0,029	0,029	0,030	0,029	0,029	0,029	0,031	0,030
7,9	0,028	0,030	0,029	0,029	0,029	0,030	0,029	0,029	0,029	0,030	0,030
8,1	0,028	0,030	0,029	0,029	0,029	0,030	0,030	0,030	0,030	0,032	0,030
8,3	0,036	0,038	0,037	0,038	0,038	0,037	0,038	0,038	0,038	0,038	0,039
8,5	0,036	0,039	0,038	0,037	0,037	0,037	0,037	0,038	0,037	0,038	0,038
8,7	0,025	0,027	0,026	0,026	0,026	0,027	0,027	0,027	0,027	0,028	0,028
8,9	0,025	0,027	0,026	0,026	0,026	0,026	0,026	0,026	0,026	0,027	0,027

Harmonic: HYD 6KTL-3PH											
P/P _n [%]	0	10	20	30	40	50	60	70	80	90	100
Order	I [%]	I [%]	I [%]	I [%]	I [%]	I [%]	I [%]	I [%]	I [%]	I [%]	I [%]
1	1,763	9,277	19,363	29,502	39,672	49,832	59,981	70,113	80,243	90,297	100,460
2	0,118	0,195	0,204	0,174	0,151	0,115	0,112	0,114	0,113	0,144	0,113
3	0,079	0,161	0,190	0,124	0,118	0,140	0,150	0,195	0,178	0,178	0,164
4	0,084	0,216	0,191	0,152	0,114	0,092	0,089	0,087	0,085	0,102	0,082
5	0,497	1,011	0,850	0,461	0,476	0,617	0,688	0,697	0,709	0,708	0,690
6	0,050	0,162	0,138	0,127	0,099	0,097	0,094	0,095	0,091	0,111	0,089
7	0,772	0,823	0,890	0,498	0,208	0,203	0,234	0,215	0,216	0,321	0,260
8	0,101	0,169	0,134	0,110	0,082	0,079	0,089	0,092	0,086	0,093	0,078
9	0,068	0,142	0,165	0,176	0,161	0,170	0,206	0,197	0,185	0,164	0,157
10	0,092	0,158	0,128	0,106	0,088	0,085	0,080	0,076	0,071	0,078	0,070
11	0,475	0,702	1,032	1,163	0,575	0,251	0,401	0,548	0,617	0,647	0,617
12	0,055	0,140	0,121	0,086	0,064	0,061	0,063	0,061	0,059	0,061	0,054
13	0,537	0,580	0,788	0,578	0,375	0,428	0,580	0,590	0,520	0,450	0,413
14	0,161	0,263	0,094	0,101	0,078	0,067	0,068	0,061	0,058	0,059	0,053
15	0,081	0,109	0,161	0,063	0,105	0,099	0,117	0,168	0,164	0,138	0,132
16	0,199	0,164	0,119	0,069	0,070	0,065	0,059	0,063	0,058	0,055	0,050
17	0,388	0,385	0,471	0,697	0,870	0,603	0,405	0,149	0,186	0,326	0,338
18	0,050	0,120	0,083	0,079	0,054	0,045	0,044	0,042	0,040	0,042	0,038
19	0,554	0,328	0,362	0,923	0,609	0,203	0,421	0,661	0,823	0,784	0,705
20	0,272	0,330	0,090	0,069	0,071	0,048	0,044	0,044	0,040	0,043	0,040
21	0,071	0,094	0,061	0,104	0,071	0,115	0,089	0,096	0,099	0,110	0,108
22	0,212	0,148	0,073	0,072	0,064	0,062	0,049	0,046	0,036	0,042	0,034
23	0,468	0,389	0,697	0,419	0,458	0,401	0,268	0,164	0,260	0,189	0,194
24	0,062	0,119	0,080	0,071	0,063	0,052	0,049	0,047	0,044	0,053	0,059
25	0,355	0,237	0,501	0,303	0,665	0,460	0,303	0,297	0,445	0,543	0,508
26	0,206	0,249	0,094	0,079	0,051	0,034	0,038	0,039	0,034	0,031	0,032
27	0,037	0,075	0,059	0,068	0,065	0,044	0,054	0,054	0,059	0,070	0,063
28	0,210	0,188	0,104	0,080	0,037	0,030	0,034	0,034	0,032	0,037	0,027
29	0,145	0,233	0,322	0,365	0,487	0,445	0,146	0,103	0,149	0,143	0,213
30	0,035	0,088	0,057	0,041	0,032	0,033	0,031	0,030	0,028	0,032	0,028
31	0,238	0,249	0,257	0,348	0,398	0,355	0,166	0,181	0,185	0,175	0,154
32	0,124	0,192	0,125	0,084	0,080	0,064	0,046	0,043	0,036	0,028	0,030
33	0,046	0,061	0,056	0,045	0,074	0,060	0,071	0,090	0,085	0,072	0,090
34	0,207	0,201	0,108	0,078	0,053	0,049	0,041	0,037	0,036	0,035	0,033
35	0,107	0,137	0,118	0,154	0,213	0,171	0,365	0,301	0,194	0,114	0,177
36	0,037	0,072	0,057	0,048	0,033	0,042	0,035	0,033	0,030	0,033	0,028
37	0,070	0,166	0,249	0,175	0,196	0,207	0,313	0,129	0,108	0,243	0,328
38	0,303	0,315	0,082	0,064	0,044	0,051	0,037	0,028	0,032	0,033	0,027
39	0,049	0,044	0,050	0,069	0,076	0,093	0,066	0,079	0,096	0,106	0,112
40	0,313	0,314	0,165	0,110	0,056	0,051	0,035	0,032	0,032	0,030	0,028

Interharmonics: HYD 6KTL-3PH											
P/P _n [%]	0	10	20	30	40	50	60	70	80	90	100
f [Hz]	I [%]	I [%]	I [%]	I [%]	I [%]	I [%]	I [%]	I [%]	I [%]	I [%]	I [%]
75	0,036	0,253	0,253	0,272	0,197	0,161	0,157	0,172	0,166	0,257	0,171
125	0,045	0,099	0,099	0,107	0,091	0,081	0,080	0,086	0,083	0,107	0,081
175	0,049	0,110	0,110	0,115	0,099	0,093	0,098	0,098	0,098	0,114	0,097
225	0,047	0,224	0,224	0,184	0,115	0,104	0,114	0,114	0,116	0,133	0,117
275	0,047	0,233	0,233	0,188	0,122	0,114	0,123	0,126	0,127	0,140	0,124
325	0,050	0,221	0,221	0,208	0,134	0,116	0,121	0,126	0,125	0,137	0,118
375	0,050	0,231	0,231	0,175	0,118	0,111	0,116	0,124	0,122	0,139	0,118
425	0,050	0,103	0,103	0,105	0,097	0,094	0,095	0,098	0,098	0,100	0,092
475	0,046	0,092	0,092	0,089	0,086	0,084	0,083	0,085	0,085	0,090	0,084
525	0,043	0,175	0,175	0,134	0,097	0,077	0,074	0,074	0,073	0,075	0,074
575	0,040	0,187	0,187	0,147	0,099	0,074	0,071	0,070	0,069	0,071	0,067
625	0,037	0,168	0,168	0,117	0,088	0,068	0,064	0,063	0,062	0,067	0,062
675	0,035	0,166	0,166	0,134	0,097	0,065	0,058	0,056	0,055	0,067	0,060
725	0,033	0,077	0,077	0,069	0,064	0,053	0,052	0,052	0,051	0,054	0,052
775	0,031	0,072	0,072	0,064	0,059	0,048	0,048	0,051	0,050	0,050	0,049
825	0,030	0,132	0,132	0,106	0,066	0,047	0,047	0,051	0,049	0,050	0,049
875	0,029	0,132	0,132	0,100	0,071	0,049	0,047	0,048	0,046	0,048	0,045
925	0,031	0,119	0,119	0,099	0,063	0,046	0,047	0,047	0,045	0,046	0,044
975	0,027	0,109	0,109	0,093	0,058	0,044	0,041	0,040	0,038	0,041	0,040
1025	0,030	0,056	0,056	0,056	0,046	0,044	0,041	0,038	0,038	0,040	0,039
1075	0,025	0,050	0,050	0,050	0,043	0,041	0,037	0,034	0,034	0,037	0,037
1125	0,025	0,090	0,090	0,085	0,056	0,041	0,037	0,035	0,035	0,042	0,038
1175	0,026	0,087	0,087	0,086	0,052	0,041	0,038	0,038	0,037	0,038	0,036
1225	0,029	0,088	0,088	0,080	0,057	0,051	0,054	0,054	0,055	0,049	0,035
1275	0,025	0,084	0,084	0,074	0,049	0,034	0,033	0,034	0,032	0,034	0,033
1325	0,030	0,050	0,050	0,047	0,039	0,035	0,035	0,036	0,035	0,035	0,034
1375	0,025	0,047	0,047	0,041	0,035	0,030	0,032	0,032	0,031	0,032	0,030
1425	0,030	0,080	0,080	0,066	0,047	0,039	0,036	0,036	0,035	0,038	0,037
1475	0,025	0,078	0,078	0,060	0,042	0,034	0,034	0,034	0,032	0,034	0,032
1525	0,025	0,075	0,075	0,057	0,041	0,035	0,032	0,033	0,033	0,037	0,034
1575	0,025	0,069	0,069	0,053	0,039	0,036	0,033	0,032	0,032	0,036	0,035
1625	0,026	0,041	0,041	0,034	0,032	0,032	0,030	0,031	0,031	0,031	0,031
1675	0,026	0,038	0,038	0,033	0,030	0,031	0,031	0,031	0,031	0,032	0,031
1725	0,026	0,046	0,046	0,040	0,032	0,032	0,031	0,031	0,030	0,032	0,031
1775	0,026	0,043	0,043	0,038	0,033	0,032	0,031	0,032	0,030	0,032	0,030
1825	0,026	0,047	0,047	0,040	0,034	0,033	0,030	0,031	0,030	0,032	0,030
1875	0,026	0,044	0,044	0,038	0,033	0,032	0,030	0,030	0,029	0,030	0,030
1925	0,029	0,034	0,034	0,032	0,031	0,030	0,030	0,030	0,030	0,031	0,030
1975	0,028	0,034	0,034	0,031	0,029	0,029	0,029	0,030	0,029	0,030	0,030

Higher Frequencies: HYD 6KTL-3PH											
P/P _n [%]	0	10	20	30	40	50	60	70	80	90	100
f [kHz]	l [%]	l [%]	l [%]	l [%]	l [%]	l [%]	l [%]	l [%]	l [%]	l [%]	l [%]
2,1	0,339	0,262	0,403	0,271	0,410	0,404	0,575	0,476	0,339	0,335	0,465
2,3	0,372	0,333	0,293	0,392	0,259	0,293	0,241	0,322	0,273	0,240	0,258
2,5	0,341	0,302	0,289	0,399	0,298	0,261	0,361	0,270	0,218	0,268	0,325
2,7	0,413	0,260	0,325	0,284	0,320	0,328	0,277	0,305	0,204	0,255	0,320
2,9	0,152	0,229	0,239	0,223	0,238	0,231	0,205	0,316	0,242	0,213	0,241
3,1	0,232	0,227	0,256	0,229	0,231	0,235	0,194	0,276	0,249	0,179	0,204
3,3	0,263	0,223	0,248	0,228	0,286	0,326	0,248	0,314	0,317	0,229	0,237
3,5	0,131	0,183	0,209	0,194	0,211	0,191	0,241	0,203	0,235	0,216	0,208
3,7	0,108	0,146	0,161	0,172	0,168	0,184	0,172	0,182	0,170	0,172	0,179
3,9	0,077	0,097	0,105	0,114	0,106	0,115	0,126	0,117	0,117	0,117	0,116
4,1	0,063	0,075	0,080	0,083	0,083	0,086	0,087	0,086	0,087	0,088	0,088
4,3	0,055	0,063	0,066	0,068	0,068	0,068	0,072	0,070	0,073	0,071	0,072
4,5	0,048	0,054	0,056	0,057	0,058	0,060	0,060	0,060	0,062	0,062	0,062
4,7	0,089	0,095	0,098	0,100	0,101	0,101	0,101	0,102	0,102	0,103	0,103
4,9	0,040	0,043	0,044	0,045	0,045	0,046	0,046	0,047	0,047	0,048	0,049
5,1	0,039	0,041	0,042	0,042	0,043	0,043	0,043	0,044	0,044	0,045	0,045
5,3	0,035	0,037	0,037	0,038	0,038	0,038	0,039	0,039	0,039	0,040	0,040
5,5	0,033	0,034	0,035	0,035	0,035	0,036	0,036	0,036	0,037	0,037	0,037
5,7	0,034	0,035	0,035	0,036	0,036	0,036	0,036	0,037	0,037	0,037	0,037
5,9	0,030	0,031	0,031	0,031	0,032	0,032	0,032	0,032	0,033	0,033	0,033
6,1	0,039	0,040	0,040	0,040	0,040	0,040	0,041	0,041	0,041	0,041	0,041
6,3	0,028	0,029	0,029	0,029	0,029	0,030	0,030	0,030	0,031	0,030	0,031
6,5	0,027	0,028	0,028	0,028	0,028	0,028	0,029	0,029	0,029	0,029	0,029
6,7	0,027	0,028	0,027	0,027	0,028	0,028	0,028	0,028	0,029	0,028	0,029
6,9	0,027	0,027	0,027	0,027	0,027	0,028	0,028	0,029	0,028	0,028	0,028
7,1	0,044	0,046	0,045	0,045	0,045	0,045	0,045	0,046	0,046	0,046	0,046
7,3	0,025	0,026	0,026	0,027	0,027	0,027	0,027	0,028	0,027	0,028	0,027
7,5	0,025	0,026	0,025	0,025	0,026	0,026	0,026	0,027	0,026	0,027	0,026
7,7	0,024	0,024	0,024	0,024	0,024	0,024	0,024	0,025	0,025	0,025	0,025
7,9	0,023	0,024	0,024	0,024	0,024	0,024	0,025	0,025	0,025	0,025	0,025
8,1	0,023	0,024	0,024	0,024	0,024	0,025	0,025	0,025	0,026	0,025	0,025
8,3	0,031	0,031	0,031	0,031	0,031	0,031	0,031	0,031	0,032	0,032	0,032
8,5	0,031	0,032	0,031	0,031	0,031	0,031	0,031	0,031	0,031	0,032	0,031
8,7	0,021	0,022	0,022	0,022	0,022	0,022	0,022	0,023	0,024	0,023	0,023
8,9	0,020	0,022	0,021	0,022	0,022	0,022	0,022	0,022	0,023	0,022	0,023

Harmonic: HYD 8KTL-3PH											
P/P _n [%]	0	10	20	30	40	50	60	70	80	90	100
Order	I [%]	I [%]	I [%]	I [%]	I [%]	I [%]	I [%]	I [%]	I [%]	I [%]	I [%]
1	1,332	9,351	19,329	29,328	39,363	49,370	59,365	69,337	79,265	89,251	99,193
2	0,089	0,173	0,138	0,124	0,090	0,086	0,084	0,081	0,099	0,082	0,077
3	0,060	0,163	0,117	0,093	0,114	0,132	0,133	0,132	0,115	0,112	0,110
4	0,064	0,185	0,128	0,098	0,070	0,064	0,062	0,061	0,069	0,059	0,057
5	0,368	0,836	0,400	0,365	0,488	0,509	0,531	0,535	0,507	0,498	0,498
6	0,039	0,123	0,097	0,084	0,075	0,069	0,071	0,069	0,072	0,064	0,061
7	0,572	0,799	0,479	0,177	0,153	0,160	0,165	0,183	0,241	0,205	0,196
8	0,078	0,115	0,090	0,064	0,060	0,067	0,064	0,064	0,062	0,055	0,056
9	0,053	0,138	0,141	0,119	0,137	0,146	0,139	0,126	0,108	0,098	0,094
10	0,072	0,089	0,087	0,067	0,064	0,058	0,053	0,055	0,055	0,049	0,046
11	0,359	0,446	0,945	0,468	0,209	0,367	0,462	0,484	0,446	0,402	0,398
12	0,042	0,080	0,071	0,055	0,048	0,046	0,046	0,044	0,041	0,038	0,038
13	0,394	0,448	0,517	0,314	0,355	0,445	0,392	0,340	0,285	0,246	0,244
14	0,125	0,176	0,075	0,063	0,052	0,048	0,043	0,041	0,041	0,038	0,042
15	0,060	0,081	0,064	0,080	0,074	0,115	0,122	0,109	0,093	0,084	0,084
16	0,150	0,135	0,055	0,054	0,046	0,045	0,046	0,042	0,037	0,034	0,030
17	0,287	0,527	0,394	0,660	0,395	0,193	0,127	0,240	0,283	0,265	0,253
18	0,038	0,071	0,054	0,041	0,035	0,031	0,031	0,031	0,029	0,026	0,025
19	0,415	0,314	0,558	0,480	0,194	0,429	0,610	0,593	0,480	0,424	0,433
20	0,206	0,165	0,054	0,055	0,037	0,034	0,031	0,028	0,030	0,028	0,031
21	0,056	0,060	0,077	0,051	0,085	0,065	0,074	0,082	0,082	0,069	0,069
22	0,159	0,078	0,071	0,050	0,044	0,035	0,027	0,029	0,027	0,022	0,020
23	0,351	0,407	0,274	0,357	0,269	0,143	0,183	0,160	0,138	0,143	0,130
24	0,036	0,054	0,051	0,038	0,029	0,029	0,025	0,026	0,035	0,021	0,022
25	0,261	0,240	0,324	0,504	0,299	0,193	0,327	0,397	0,401	0,369	0,362
26	0,146	0,071	0,074	0,042	0,026	0,028	0,028	0,023	0,023	0,023	0,027
27	0,027	0,036	0,046	0,051	0,030	0,043	0,046	0,046	0,054	0,038	0,042
28	0,153	0,099	0,070	0,030	0,021	0,024	0,024	0,023	0,023	0,018	0,017
29	0,117	0,181	0,340	0,344	0,282	0,060	0,109	0,126	0,176	0,223	0,211
30	0,025	0,050	0,034	0,024	0,024	0,025	0,021	0,022	0,023	0,020	0,020
31	0,180	0,122	0,310	0,281	0,220	0,114	0,132	0,100	0,188	0,200	0,184
32	0,112	0,095	0,079	0,057	0,046	0,034	0,029	0,023	0,021	0,020	0,024
33	0,033	0,050	0,050	0,055	0,045	0,061	0,065	0,063	0,064	0,058	0,054
34	0,162	0,139	0,079	0,041	0,036	0,026	0,027	0,026	0,024	0,020	0,018
35	0,080	0,135	0,172	0,164	0,174	0,264	0,157	0,096	0,170	0,243	0,253
36	0,029	0,059	0,031	0,026	0,033	0,026	0,024	0,021	0,022	0,021	0,020
37	0,056	0,121	0,215	0,161	0,186	0,158	0,073	0,196	0,281	0,324	0,316
38	0,231	0,208	0,048	0,036	0,036	0,023	0,021	0,023	0,023	0,019	0,021
39	0,037	0,027	0,033	0,050	0,063	0,055	0,071	0,085	0,079	0,088	0,100
40	0,247	0,231	0,095	0,044	0,036	0,023	0,024	0,021	0,022	0,022	0,022

Interharmonics: HYD 8KTL-3PH											
P/P _n [%]	0	10	20	30	40	50	60	70	80	90	100
f [Hz]	I [%]	I [%]	I [%]	I [%]	I [%]	I [%]	I [%]	I [%]	I [%]	I [%]	I [%]
75	0,028	0,212	0,194	0,180	0,122	0,115	0,113	0,112	0,162	0,120	0,115
125	0,035	0,082	0,079	0,077	0,062	0,057	0,057	0,062	0,067	0,056	0,055
175	0,038	0,084	0,083	0,081	0,071	0,070	0,071	0,075	0,074	0,070	0,070
225	0,037	0,187	0,151	0,097	0,082	0,084	0,085	0,089	0,091	0,084	0,084
275	0,038	0,199	0,160	0,104	0,085	0,090	0,093	0,100	0,097	0,093	0,093
325	0,039	0,175	0,155	0,113	0,088	0,090	0,091	0,092	0,094	0,088	0,088
375	0,039	0,200	0,137	0,092	0,081	0,087	0,089	0,088	0,094	0,085	0,086
425	0,042	0,086	0,079	0,074	0,070	0,071	0,071	0,073	0,072	0,070	0,071
475	0,040	0,077	0,070	0,068	0,064	0,061	0,062	0,064	0,063	0,063	0,065
525	0,036	0,160	0,105	0,081	0,059	0,054	0,054	0,054	0,054	0,055	0,056
575	0,033	0,162	0,116	0,085	0,056	0,049	0,048	0,051	0,050	0,049	0,051
625	0,030	0,138	0,093	0,075	0,052	0,045	0,044	0,046	0,048	0,046	0,046
675	0,028	0,154	0,101	0,085	0,048	0,042	0,041	0,042	0,048	0,045	0,044
725	0,026	0,065	0,053	0,052	0,040	0,039	0,037	0,039	0,039	0,038	0,040
775	0,025	0,056	0,047	0,048	0,036	0,037	0,036	0,037	0,036	0,037	0,039
825	0,024	0,103	0,080	0,054	0,034	0,036	0,036	0,035	0,035	0,036	0,037
875	0,023	0,109	0,077	0,058	0,036	0,034	0,034	0,033	0,034	0,034	0,035
925	0,025	0,089	0,075	0,050	0,034	0,034	0,033	0,033	0,032	0,032	0,033
975	0,021	0,099	0,072	0,048	0,034	0,029	0,028	0,029	0,029	0,028	0,029
1025	0,024	0,048	0,045	0,036	0,033	0,029	0,028	0,029	0,029	0,028	0,029
1075	0,020	0,043	0,039	0,034	0,031	0,026	0,025	0,028	0,028	0,026	0,028
1125	0,020	0,072	0,060	0,047	0,030	0,026	0,026	0,028	0,029	0,026	0,027
1175	0,020	0,075	0,067	0,045	0,030	0,027	0,026	0,027	0,027	0,026	0,027
1225	0,038	0,076	0,065	0,059	0,048	0,046	0,046	0,047	0,040	0,048	0,045
1275	0,019	0,066	0,060	0,040	0,031	0,024	0,024	0,023	0,025	0,024	0,024
1325	0,024	0,037	0,036	0,031	0,026	0,028	0,027	0,026	0,026	0,025	0,026
1375	0,019	0,033	0,030	0,027	0,022	0,028	0,023	0,023	0,023	0,022	0,022
1425	0,024	0,055	0,050	0,037	0,027	0,027	0,031	0,028	0,028	0,026	0,026
1475	0,019	0,055	0,048	0,034	0,024	0,025	0,024	0,029	0,025	0,023	0,024
1525	0,021	0,049	0,044	0,032	0,024	0,024	0,024	0,025	0,027	0,024	0,025
1575	0,019	0,051	0,042	0,030	0,026	0,023	0,023	0,024	0,027	0,025	0,026
1625	0,019	0,030	0,025	0,024	0,023	0,022	0,023	0,024	0,023	0,024	0,024
1675	0,020	0,030	0,023	0,023	0,024	0,023	0,023	0,023	0,023	0,024	0,024
1725	0,020	0,037	0,031	0,026	0,025	0,023	0,022	0,023	0,023	0,023	0,024
1775	0,020	0,033	0,030	0,027	0,025	0,023	0,022	0,023	0,023	0,023	0,024
1825	0,021	0,033	0,032	0,027	0,024	0,023	0,022	0,022	0,023	0,022	0,024
1875	0,021	0,032	0,031	0,026	0,024	0,023	0,021	0,022	0,023	0,022	0,023
1925	0,023	0,028	0,024	0,023	0,023	0,022	0,022	0,022	0,023	0,022	0,023
1975	0,022	0,028	0,024	0,023	0,023	0,022	0,021	0,022	0,022	0,022	0,023

Higher Frequencies: HYD 8KTL-3PH											
P/P _n [%]	0	10	20	30	40	50	60	70	80	90	100
f [kHz]	I [%]	I [%]	I [%]	I [%]	I [%]	I [%]	I [%]	I [%]	I [%]	I [%]	I [%]
2,1	0,252	0,229	0,262	0,309	0,360	0,413	0,261	0,297	0,361	0,430	0,426
2,3	0,274	0,264	0,215	0,187	0,193	0,235	0,213	0,175	0,216	0,253	0,281
2,5	0,257	0,266	0,206	0,217	0,233	0,247	0,163	0,223	0,231	0,237	0,216
2,7	0,317	0,262	0,293	0,233	0,193	0,245	0,164	0,183	0,242	0,266	0,268
2,9	0,114	0,187	0,182	0,199	0,152	0,212	0,190	0,131	0,175	0,201	0,207
3,1	0,172	0,202	0,172	0,188	0,166	0,194	0,193	0,130	0,182	0,208	0,233
3,3	0,194	0,187	0,194	0,211	0,261	0,198	0,240	0,168	0,188	0,236	0,266
3,5	0,099	0,144	0,145	0,152	0,159	0,154	0,174	0,163	0,158	0,181	0,206
3,7	0,080	0,116	0,125	0,126	0,131	0,135	0,127	0,127	0,134	0,139	0,142
3,9	0,057	0,077	0,079	0,080	0,085	0,089	0,088	0,086	0,087	0,093	0,096
4,1	0,047	0,058	0,061	0,062	0,063	0,065	0,064	0,065	0,066	0,068	0,069
4,3	0,041	0,049	0,051	0,051	0,052	0,052	0,055	0,053	0,055	0,058	0,059
4,5	0,036	0,042	0,043	0,044	0,044	0,046	0,046	0,046	0,047	0,048	0,050
4,7	0,067	0,072	0,074	0,075	0,076	0,076	0,077	0,077	0,077	0,078	0,078
4,9	0,030	0,033	0,034	0,034	0,035	0,035	0,035	0,036	0,037	0,038	0,038
5,1	0,029	0,031	0,031	0,032	0,033	0,033	0,033	0,034	0,034	0,035	0,036
5,3	0,026	0,028	0,028	0,028	0,029	0,029	0,030	0,030	0,030	0,031	0,032
5,5	0,025	0,026	0,026	0,026	0,027	0,027	0,028	0,028	0,028	0,029	0,029
5,7	0,025	0,026	0,026	0,027	0,027	0,027	0,028	0,028	0,028	0,029	0,029
5,9	0,022	0,023	0,023	0,024	0,024	0,024	0,024	0,025	0,025	0,025	0,026
6,1	0,029	0,030	0,030	0,030	0,030	0,031	0,031	0,031	0,031	0,031	0,031
6,3	0,021	0,022	0,022	0,022	0,022	0,023	0,023	0,023	0,023	0,023	0,024
6,5	0,020	0,021	0,021	0,021	0,021	0,022	0,022	0,022	0,022	0,022	0,023
6,7	0,020	0,021	0,021	0,021	0,021	0,022	0,022	0,021	0,022	0,022	0,022
6,9	0,020	0,021	0,020	0,020	0,021	0,021	0,021	0,021	0,021	0,021	0,022
7,1	0,033	0,034	0,034	0,034	0,034	0,034	0,034	0,034	0,034	0,034	0,035
7,3	0,019	0,020	0,020	0,020	0,020	0,020	0,020	0,021	0,021	0,021	0,021
7,5	0,018	0,019	0,019	0,019	0,020	0,019	0,020	0,020	0,020	0,020	0,021
7,7	0,018	0,018	0,018	0,018	0,018	0,018	0,019	0,019	0,019	0,019	0,019
7,9	0,017	0,018	0,018	0,018	0,018	0,018	0,019	0,019	0,019	0,019	0,019
8,1	0,018	0,018	0,018	0,019	0,018	0,019	0,019	0,019	0,019	0,019	0,019
8,3	0,023	0,023	0,023	0,024	0,024	0,023	0,024	0,024	0,024	0,024	0,024
8,5	0,023	0,023	0,023	0,023	0,023	0,023	0,024	0,024	0,023	0,024	0,024
8,7	0,016	0,016	0,016	0,016	0,017	0,017	0,018	0,018	0,017	0,018	0,018
8,9	0,015	0,016	0,016	0,016	0,016	0,016	0,017	0,017	0,017	0,017	0,017

Harminoc: HYD 10KTL-3PH											
P/P _n [%]	0	10	20	30	40	50	60	70	80	90	100
Order	I [%]	I [%]	I [%]	I [%]	I [%]	I [%]	I [%]	I [%]	I [%]	I [%]	I [%]
1	6,14	10,75	20,72	30,66	40,51	50,66	60,68	70,75	80,75	90,76	100,53
2	0,381	0,365	0,380	0,373	0,373	0,352	0,325	0,315	0,314	0,313	0,310
3	0,293	0,313	0,355	0,388	0,364	0,313	0,318	0,329	0,335	0,340	0,334
4	0,243	0,282	0,295	0,388	0,353	0,346	0,263	0,264	0,267	0,263	0,258
5	0,599	0,483	0,616	0,632	0,616	0,638	0,633	0,656	0,681	0,691	0,714
6	0,235	0,256	0,246	0,242	0,246	0,243	0,239	0,240	0,240	0,239	0,239
7	0,542	0,383	0,370	0,414	0,419	0,405	0,373	0,364	0,356	0,356	0,334
8	0,153	0,144	0,146	0,152	0,147	0,147	0,143	0,146	0,149	0,151	0,152
9	0,111	0,051	0,055	0,059	0,059	0,060	0,063	0,062	0,065	0,075	0,074
10	0,098	0,070	0,083	0,083	0,077	0,077	0,075	0,079	0,080	0,081	0,080
11	0,244	0,217	0,220	0,240	0,275	0,265	0,169	0,126	0,130	0,119	0,105
12	0,127	0,062	0,053	0,049	0,053	0,082	0,071	0,082	0,070	0,080	0,082
13	0,166	0,157	0,143	0,151	0,276	0,291	0,219	0,204	0,219	0,235	0,232
14	0,099	0,065	0,024	0,036	0,031	0,028	0,026	0,026	0,025	0,026	0,027
15	0,141	0,029	0,085	0,080	0,107	0,104	0,101	0,101	0,100	0,097	0,096
16	0,117	0,079	0,019	0,022	0,017	0,015	0,015	0,015	0,015	0,017	0,018
17	0,125	0,054	0,240	0,075	0,227	0,262	0,165	0,149	0,186	0,200	0,204
18	0,085	0,068	0,028	0,021	0,020	0,020	0,016	0,014	0,014	0,017	0,019
19	0,101	0,081	0,231	0,076	0,218	0,251	0,150	0,058	0,041	0,054	0,061
20	0,071	0,042	0,021	0,017	0,018	0,016	0,016	0,015	0,013	0,015	0,017
21	0,078	0,067	0,072	0,105	0,118	0,106	0,098	0,090	0,086	0,077	0,077
22	0,060	0,046	0,020	0,015	0,015	0,013	0,012	0,011	0,010	0,011	0,011
23	0,041	0,050	0,186	0,064	0,204	0,262	0,162	0,050	0,028	0,049	0,068
24	0,057	0,068	0,022	0,015	0,012	0,016	0,019	0,018	0,019	0,019	0,016
25	0,101	0,121	0,151	0,147	0,209	0,235	0,350	0,403	0,401	0,362	0,339
26	0,025	0,057	0,026	0,019	0,021	0,017	0,016	0,026	0,020	0,016	0,011
27	0,117	0,094	0,132	0,186	0,157	0,303	0,432	0,290	0,280	0,244	0,213
28	0,026	0,026	0,012	0,010	0,011	0,016	0,020	0,023	0,018	0,025	0,021
29	0,076	0,107	0,161	0,113	0,211	0,325	0,462	0,496	0,536	0,425	0,418
30	0,028	0,032	0,014	0,010	0,009	0,010	0,011	0,023	0,019	0,020	0,025
31	0,062	0,080	0,104	0,057	0,092	0,082	0,138	0,215	0,287	0,252	0,387
32	0,028	0,015	0,017	0,011	0,010	0,010	0,010	0,011	0,015	0,024	0,032
33	0,076	0,032	0,048	0,027	0,053	0,075	0,060	0,047	0,072	0,099	0,215
34	0,027	0,036	0,014	0,011	0,010	0,010	0,011	0,009	0,009	0,011	0,024
35	0,038	0,064	0,054	0,057	0,087	0,086	0,046	0,103	0,142	0,192	0,253
36	0,038	0,032	0,017	0,014	0,014	0,013	0,014	0,013	0,013	0,014	0,014
37	0,030	0,064	0,029	0,048	0,078	0,106	0,050	0,031	0,027	0,026	0,021
38	0,025	0,016	0,016	0,013	0,012	0,012	0,010	0,012	0,012	0,012	0,014
39	0,024	0,026	0,020	0,023	0,031	0,036	0,035	0,044	0,053	0,057	0,056
40	0,048	0,029	0,014	0,013	0,011	0,011	0,011	0,011	0,011	0,010	0,011

Interharmonics: HYD 10KTL-3PH											
P/P _n [%]	0	10	20	30	40	50	60	70	80	90	100
f [Hz]	I [%]	I [%]	I [%]	I [%]	I [%]	I [%]	I [%]	I [%]	I [%]	I [%]	I [%]
75	0,135	0,190	0,250	0,250	0,239	0,137	0,156	0,125	0,126	0,125	0,110
125	0,091	0,134	0,204	0,203	0,190	0,120	0,126	0,112	0,110	0,110	0,099
175	0,068	0,097	0,120	0,136	0,127	0,088	0,082	0,087	0,091	0,089	0,085
225	0,076	0,080	0,083	0,097	0,088	0,080	0,051	0,053	0,054	0,061	0,060
275	0,064	0,057	0,062	0,056	0,059	0,042	0,043	0,046	0,045	0,045	0,045
325	0,056	0,047	0,049	0,042	0,041	0,033	0,032	0,031	0,032	0,035	0,038
375	0,052	0,041	0,037	0,034	0,031	0,024	0,025	0,026	0,026	0,027	0,026
425	0,039	0,034	0,026	0,028	0,027	0,021	0,021	0,022	0,022	0,022	0,022
475	0,034	0,030	0,026	0,023	0,022	0,019	0,021	0,020	0,018	0,018	0,019
525	0,079	0,110	0,042	0,112	0,074	0,017	0,018	0,017	0,017	0,017	0,017
575	0,043	0,033	0,074	0,023	0,023	0,059	0,081	0,051	0,056	0,027	0,020
625	0,036	0,030	0,024	0,021	0,018	0,042	0,020	0,022	0,022	0,023	0,036
675	0,034	0,026	0,020	0,018	0,016	0,015	0,015	0,015	0,014	0,013	0,014
725	0,028	0,020	0,015	0,014	0,014	0,013	0,013	0,013	0,012	0,013	0,013
775	0,023	0,019	0,015	0,014	0,014	0,012	0,012	0,012	0,011	0,012	0,012
825	0,028	0,022	0,018	0,016	0,014	0,011	0,012	0,012	0,011	0,011	0,012
875	0,027	0,019	0,015	0,015	0,013	0,012	0,013	0,012	0,012	0,012	0,012
925	0,026	0,020	0,017	0,016	0,014	0,013	0,013	0,012	0,013	0,014	0,015
975	0,024	0,019	0,014	0,013	0,012	0,011	0,011	0,011	0,010	0,011	0,011
1025	0,023	0,015	0,013	0,013	0,013	0,012	0,013	0,013	0,013	0,013	0,013
1075	0,020	0,017	0,012	0,013	0,014	0,011	0,011	0,011	0,010	0,011	0,011
1125	0,018	0,014	0,016	0,013	0,012	0,011	0,011	0,011	0,011	0,011	0,011
1175	0,017	0,016	0,013	0,012	0,012	0,014	0,014	0,013	0,013	0,012	0,011
1225	0,017	0,016	0,014	0,013	0,012	0,014	0,015	0,013	0,013	0,013	0,014
1275	0,015	0,016	0,014	0,014	0,013	0,012	0,016	0,015	0,013	0,013	0,012
1325	0,017	0,015	0,016	0,016	0,018	0,017	0,017	0,017	0,020	0,018	0,017
1375	0,014	0,012	0,011	0,011	0,013	0,014	0,018	0,014	0,015	0,018	0,015
1425	0,017	0,015	0,015	0,014	0,014	0,016	0,020	0,020	0,019	0,018	0,023
1475	0,015	0,012	0,012	0,011	0,011	0,011	0,016	0,016	0,017	0,017	0,018
1525	0,015	0,013	0,012	0,011	0,010	0,010	0,012	0,016	0,020	0,020	0,021
1575	0,016	0,013	0,012	0,011	0,011	0,010	0,011	0,011	0,015	0,019	0,019
1625	0,016	0,012	0,012	0,011	0,011	0,011	0,011	0,011	0,012	0,016	0,022
1675	0,016	0,013	0,012	0,011	0,012	0,011	0,011	0,011	0,011	0,013	0,017
1725	0,017	0,014	0,014	0,012	0,012	0,012	0,013	0,012	0,012	0,014	0,016
1775	0,021	0,017	0,017	0,016	0,016	0,016	0,017	0,014	0,015	0,017	0,017
1825	0,023	0,021	0,020	0,020	0,020	0,021	0,020	0,019	0,020	0,021	0,021
1875	0,018	0,017	0,016	0,016	0,016	0,017	0,016	0,020	0,020	0,019	0,020
1925	0,018	0,016	0,015	0,015	0,015	0,015	0,015	0,017	0,017	0,016	0,017
1975	0,018	0,015	0,014	0,014	0,014	0,014	0,014	0,014	0,014	0,014	0,014

Higher Frequencies: HYD 10KTL-3PH											
P/P _n [%]	0	10	20	30	40	50	60	70	80	90	100
f [kHz]	I [%]	I [%]	I [%]	I [%]	I [%]	I [%]	I [%]	I [%]	I [%]	I [%]	I [%]
2,1	0,086	0,083	0,065	0,095	0,102	0,137	0,066	0,062	0,074	0,086	0,103
2,3	0,167	0,142	0,140	0,142	0,135	0,140	0,124	0,125	0,132	0,140	0,150
2,5	0,167	0,150	0,151	0,145	0,137	0,134	0,144	0,136	0,131	0,129	0,130
2,7	0,130	0,117	0,145	0,092	0,111	0,091	0,137	0,110	0,109	0,104	0,107
2,9	0,121	0,115	0,121	0,100	0,113	0,099	0,150	0,123	0,128	0,116	0,129
3,1	0,109	0,111	0,120	0,111	0,119	0,116	0,136	0,148	0,147	0,144	0,149
3,3	0,128	0,129	0,134	0,136	0,141	0,144	0,148	0,170	0,184	0,186	0,194
3,5	0,095	0,098	0,102	0,106	0,110	0,113	0,116	0,126	0,137	0,148	0,159
3,7	0,081	0,085	0,091	0,093	0,096	0,098	0,100	0,105	0,110	0,113	0,116
3,9	0,053	0,056	0,059	0,060	0,062	0,064	0,065	0,067	0,071	0,072	0,072
4,1	0,042	0,044	0,046	0,048	0,049	0,050	0,051	0,053	0,054	0,056	0,056
4,3	0,036	0,038	0,039	0,040	0,041	0,041	0,043	0,044	0,045	0,046	0,047
4,5	0,032	0,033	0,034	0,034	0,035	0,036	0,037	0,037	0,038	0,039	0,040
4,7	0,057	0,059	0,060	0,061	0,061	0,061	0,062	0,063	0,063	0,063	0,064
4,9	0,026	0,026	0,027	0,027	0,028	0,029	0,029	0,030	0,030	0,031	0,031
5,1	0,024	0,025	0,025	0,026	0,026	0,027	0,027	0,028	0,028	0,029	0,029
5,3	0,022	0,022	0,023	0,023	0,023	0,024	0,024	0,025	0,025	0,026	0,026
5,5	0,021	0,021	0,021	0,021	0,022	0,022	0,023	0,023	0,023	0,024	0,024
5,7	0,021	0,021	0,021	0,021	0,022	0,022	0,023	0,023	0,023	0,024	0,024
5,9	0,018	0,019	0,019	0,019	0,019	0,020	0,020	0,020	0,021	0,021	0,021
6,1	0,024	0,024	0,024	0,024	0,025	0,025	0,025	0,025	0,026	0,026	0,026
6,3	0,017	0,017	0,017	0,017	0,018	0,018	0,019	0,019	0,019	0,019	0,019
6,5	0,017	0,017	0,017	0,017	0,017	0,017	0,018	0,018	0,018	0,019	0,019
6,7	0,016	0,016	0,016	0,017	0,017	0,017	0,018	0,018	0,018	0,018	0,018
6,9	0,016	0,016	0,016	0,016	0,016	0,017	0,017	0,017	0,017	0,018	0,018
7,1	0,028	0,028	0,028	0,028	0,028	0,028	0,028	0,028	0,028	0,029	0,029
7,3	0,016	0,016	0,016	0,016	0,016	0,016	0,016	0,017	0,017	0,017	0,017
7,5	0,015	0,015	0,015	0,015	0,016	0,016	0,016	0,016	0,016	0,017	0,017
7,7	0,015	0,014	0,014	0,015	0,015	0,015	0,015	0,016	0,016	0,016	0,016
7,9	0,015	0,015	0,015	0,015	0,015	0,015	0,016	0,016	0,016	0,016	0,016
8,1	0,015	0,015	0,015	0,015	0,015	0,015	0,016	0,016	0,016	0,016	0,017
8,3	0,022	0,021	0,021	0,021	0,021	0,021	0,021	0,021	0,022	0,021	0,021
8,5	0,019	0,020	0,020	0,021	0,021	0,021	0,021	0,021	0,022	0,022	0,022
8,7	0,014	0,014	0,014	0,014	0,014	0,015	0,015	0,015	0,016	0,016	0,015
8,9	0,014	0,014	0,014	0,014	0,015	0,015	0,015	0,015	0,016	0,016	0,015

Harmonic: HYD 15KTL-3PH											
P/P _n [%]	0	10	20	30	40	50	60	70	80	90	100
Order	I [%]	I [%]	I [%]	I [%]	I [%]	I [%]	I [%]	I [%]	I [%]	I [%]	I [%]
1	5,51	10,40	20,35	30,41	40,42	50,37	60,41	70,30	80,27	90,21	100,10
2	0,263	0,261	0,236	0,243	0,261	0,265	0,270	0,282	0,293	0,310	0,318
3	0,198	0,197	0,195	0,195	0,209	0,208	0,211	0,215	0,215	0,217	0,221
4	0,169	0,184	0,169	0,166	0,173	0,168	0,169	0,170	0,170	0,174	0,173
5	0,493	0,545	0,691	0,668	0,671	0,671	0,671	0,688	0,686	0,704	0,721
6	0,169	0,147	0,141	0,140	0,140	0,143	0,141	0,144	0,145	0,144	0,146
7	0,499	0,313	0,462	0,468	0,462	0,446	0,443	0,415	0,403	0,388	0,375
8	0,125	0,075	0,079	0,077	0,081	0,084	0,083	0,083	0,085	0,085	0,087
9	0,079	0,033	0,027	0,027	0,029	0,030	0,031	0,039	0,035	0,034	0,033
10	0,115	0,051	0,054	0,049	0,050	0,047	0,052	0,048	0,049	0,047	0,049
11	0,265	0,283	0,305	0,330	0,269	0,224	0,202	0,166	0,133	0,119	0,097
12	0,108	0,072	0,023	0,027	0,031	0,036	0,034	0,040	0,039	0,038	0,036
13	0,087	0,394	0,169	0,261	0,245	0,227	0,223	0,196	0,182	0,157	0,158
14	0,117	0,065	0,017	0,014	0,016	0,021	0,024	0,029	0,030	0,029	0,027
15	0,123	0,043	0,030	0,032	0,030	0,029	0,024	0,030	0,027	0,031	0,030
16	0,119	0,081	0,015	0,013	0,017	0,014	0,015	0,019	0,018	0,015	0,015
17	0,250	0,389	0,156	0,199	0,137	0,171	0,162	0,134	0,111	0,098	0,090
18	0,092	0,070	0,019	0,022	0,018	0,020	0,023	0,027	0,026	0,023	0,020
19	0,231	0,331	0,102	0,164	0,095	0,135	0,122	0,087	0,066	0,056	0,049
20	0,055	0,058	0,015	0,016	0,013	0,018	0,018	0,023	0,023	0,021	0,020
21	0,064	0,044	0,024	0,029	0,029	0,028	0,023	0,026	0,023	0,023	0,022
22	0,060	0,056	0,016	0,017	0,011	0,011	0,013	0,017	0,017	0,016	0,015
23	0,153	0,201	0,091	0,150	0,035	0,105	0,084	0,059	0,046	0,050	0,077
24	0,055	0,039	0,017	0,021	0,009	0,016	0,018	0,021	0,021	0,019	0,017
25	0,091	0,153	0,101	0,110	0,041	0,142	0,149	0,128	0,118	0,105	0,094
26	0,046	0,034	0,013	0,015	0,010	0,014	0,015	0,020	0,020	0,018	0,017
27	0,037	0,035	0,022	0,022	0,026	0,031	0,029	0,034	0,027	0,024	0,023
28	0,019	0,016	0,012	0,014	0,009	0,012	0,012	0,015	0,014	0,014	0,013
29	0,061	0,118	0,156	0,084	0,086	0,149	0,149	0,138	0,120	0,111	0,113
30	0,029	0,030	0,011	0,012	0,010	0,015	0,016	0,021	0,021	0,018	0,015
31	0,039	0,124	0,158	0,067	0,179	0,214	0,146	0,057	0,045	0,079	0,096
32	0,036	0,022	0,012	0,009	0,011	0,017	0,014	0,018	0,020	0,019	0,016
33	0,053	0,037	0,017	0,099	0,086	0,065	0,042	0,041	0,046	0,046	0,041
34	0,034	0,011	0,013	0,010	0,009	0,011	0,012	0,015	0,019	0,020	0,018
35	0,101	0,131	0,154	0,112	0,197	0,212	0,160	0,085	0,048	0,080	0,109
36	0,015	0,013	0,012	0,008	0,012	0,015	0,012	0,016	0,020	0,020	0,021
37	0,127	0,116	0,133	0,053	0,100	0,082	0,045	0,042	0,097	0,192	0,332
38	0,018	0,017	0,012	0,008	0,011	0,011	0,010	0,015	0,017	0,017	0,019
39	0,018	0,025	0,024	0,018	0,020	0,024	0,026	0,030	0,028	0,045	0,061
40	0,023	0,025	0,013	0,010	0,008	0,009	0,009	0,011	0,010	0,014	0,018

Interharmonics: HYD 15KTL-3PH											
P/P _n [%]	0	10	20	30	40	50	60	70	80	90	100
f [Hz]	I [%]	I [%]	I [%]	I [%]	I [%]	I [%]	I [%]	I [%]	I [%]	I [%]	I [%]
75	0,118	0,135	0,080	0,082	0,109	0,084	0,082	0,081	0,084	0,082	0,074
125	0,067	0,083	0,060	0,062	0,080	0,066	0,062	0,063	0,062	0,062	0,057
175	0,044	0,058	0,041	0,043	0,053	0,049	0,049	0,051	0,051	0,052	0,050
225	0,074	0,065	0,030	0,031	0,036	0,034	0,034	0,036	0,037	0,040	0,039
275	0,054	0,045	0,026	0,026	0,029	0,026	0,026	0,027	0,028	0,031	0,031
325	0,048	0,043	0,022	0,021	0,024	0,022	0,021	0,023	0,023	0,024	0,025
375	0,040	0,036	0,019	0,018	0,020	0,018	0,017	0,018	0,019	0,020	0,020
425	0,032	0,025	0,016	0,015	0,017	0,015	0,015	0,016	0,016	0,017	0,018
475	0,027	0,023	0,014	0,012	0,014	0,013	0,013	0,013	0,014	0,015	0,015
525	0,029	0,030	0,013	0,012	0,013	0,012	0,012	0,013	0,013	0,014	0,014
575	0,030	0,030	0,012	0,011	0,012	0,011	0,011	0,012	0,012	0,012	0,013
625	0,027	0,029	0,012	0,010	0,011	0,010	0,010	0,011	0,011	0,011	0,012
675	0,028	0,029	0,011	0,011	0,011	0,009	0,009	0,010	0,010	0,011	0,011
725	0,022	0,019	0,009	0,010	0,010	0,009	0,009	0,009	0,009	0,010	0,010
775	0,020	0,016	0,010	0,009	0,010	0,008	0,008	0,009	0,009	0,009	0,009
825	0,021	0,024	0,010	0,008	0,009	0,008	0,008	0,009	0,009	0,009	0,009
875	0,021	0,022	0,009	0,008	0,009	0,008	0,009	0,008	0,008	0,009	0,009
925	0,019	0,023	0,010	0,009	0,010	0,010	0,009	0,009	0,009	0,010	0,010
975	0,018	0,020	0,008	0,007	0,008	0,007	0,007	0,008	0,008	0,008	0,008
1025	0,016	0,016	0,009	0,009	0,009	0,009	0,008	0,009	0,009	0,009	0,009
1075	0,014	0,015	0,007	0,007	0,008	0,007	0,007	0,008	0,007	0,008	0,008
1125	0,015	0,015	0,008	0,007	0,007	0,007	0,007	0,008	0,007	0,008	0,008
1175	0,015	0,016	0,008	0,007	0,008	0,007	0,007	0,008	0,008	0,008	0,008
1225	0,013	0,014	0,008	0,007	0,008	0,007	0,007	0,008	0,008	0,008	0,008
1275	0,014	0,014	0,008	0,007	0,008	0,007	0,007	0,008	0,008	0,008	0,008
1325	0,014	0,012	0,009	0,009	0,009	0,009	0,009	0,010	0,010	0,010	0,010
1375	0,012	0,009	0,007	0,007	0,007	0,007	0,007	0,008	0,008	0,008	0,008
1425	0,014	0,012	0,009	0,009	0,010	0,010	0,010	0,010	0,010	0,010	0,010
1475	0,012	0,010	0,008	0,007	0,008	0,008	0,008	0,008	0,008	0,008	0,008
1525	0,012	0,009	0,008	0,008	0,008	0,008	0,008	0,008	0,009	0,009	0,009
1575	0,012	0,010	0,008	0,008	0,008	0,009	0,009	0,009	0,009	0,009	0,009
1625	0,012	0,011	0,010	0,008	0,008	0,009	0,010	0,012	0,011	0,012	0,011
1675	0,011	0,009	0,008	0,008	0,009	0,008	0,008	0,009	0,010	0,010	0,010
1725	0,011	0,008	0,008	0,008	0,008	0,009	0,008	0,009	0,010	0,011	0,011
1775	0,011	0,009	0,008	0,008	0,008	0,008	0,009	0,009	0,010	0,010	0,011
1825	0,012	0,009	0,008	0,008	0,008	0,008	0,009	0,010	0,010	0,010	0,012
1875	0,011	0,010	0,008	0,008	0,008	0,008	0,008	0,009	0,010	0,010	0,011
1925	0,012	0,010	0,009	0,009	0,009	0,009	0,009	0,009	0,010	0,011	0,011
1975	0,011	0,010	0,009	0,009	0,009	0,009	0,009	0,009	0,009	0,010	0,012

Higher Frequencies: HYD 15KTL-3PH											
P/P _n [%]	0	10	20	30	40	50	60	70	80	90	100
f [kHz]	I [%]	I [%]	I [%]	I [%]	I [%]	I [%]	I [%]	I [%]	I [%]	I [%]	I [%]
2,1	0,069	0,111	0,129	0,053	0,124	0,095	0,077	0,088	0,133	0,221	0,376
2,3	0,105	0,103	0,110	0,087	0,117	0,098	0,089	0,090	0,103	0,108	0,118
2,5	0,108	0,106	0,119	0,086	0,124	0,110	0,099	0,086	0,081	0,089	0,086
2,7	0,075	0,089	0,143	0,065	0,121	0,107	0,083	0,064	0,073	0,086	0,102
2,9	0,075	0,077	0,089	0,068	0,068	0,090	0,080	0,072	0,080	0,086	0,092
3,1	0,076	0,079	0,081	0,071	0,073	0,106	0,097	0,088	0,086	0,094	0,105
3,3	0,077	0,082	0,082	0,083	0,085	0,112	0,107	0,106	0,108	0,118	0,128
3,5	0,063	0,068	0,072	0,074	0,075	0,085	0,093	0,103	0,111	0,116	0,124
3,7	0,055	0,061	0,065	0,064	0,066	0,071	0,073	0,077	0,079	0,080	0,082
3,9	0,036	0,039	0,043	0,042	0,043	0,045	0,047	0,047	0,047	0,048	0,049
4,1	0,029	0,030	0,032	0,033	0,034	0,035	0,036	0,037	0,038	0,038	0,038
4,3	0,025	0,026	0,027	0,028	0,029	0,029	0,030	0,031	0,031	0,031	0,032
4,5	0,021	0,022	0,023	0,024	0,025	0,025	0,026	0,026	0,026	0,026	0,026
4,7	0,038	0,039	0,040	0,041	0,041	0,041	0,042	0,042	0,042	0,042	0,042
4,9	0,017	0,018	0,018	0,019	0,020	0,020	0,020	0,021	0,021	0,021	0,022
5,1	0,016	0,017	0,017	0,017	0,018	0,019	0,019	0,019	0,020	0,020	0,020
5,3	0,015	0,015	0,015	0,016	0,016	0,017	0,017	0,017	0,017	0,018	0,018
5,5	0,014	0,014	0,014	0,015	0,015	0,015	0,016	0,016	0,016	0,016	0,017
5,7	0,014	0,014	0,014	0,015	0,015	0,015	0,016	0,016	0,016	0,016	0,017
5,9	0,012	0,012	0,013	0,013	0,013	0,014	0,014	0,014	0,014	0,014	0,015
6,1	0,016	0,016	0,016	0,016	0,017	0,017	0,017	0,017	0,017	0,018	0,018
6,3	0,011	0,011	0,012	0,012	0,012	0,012	0,013	0,013	0,013	0,013	0,014
6,5	0,011	0,011	0,011	0,011	0,012	0,012	0,012	0,012	0,012	0,013	0,013
6,7	0,011	0,011	0,011	0,011	0,012	0,012	0,012	0,012	0,012	0,012	0,013
6,9	0,011	0,010	0,011	0,011	0,011	0,011	0,012	0,012	0,012	0,012	0,012
7,1	0,018	0,018	0,018	0,018	0,019	0,019	0,019	0,019	0,019	0,019	0,019
7,3	0,010	0,010	0,010	0,011	0,011	0,011	0,011	0,011	0,011	0,011	0,012
7,5	0,010	0,010	0,010	0,011	0,011	0,011	0,011	0,011	0,011	0,011	0,011
7,7	0,009	0,009	0,010	0,010	0,010	0,010	0,010	0,011	0,011	0,011	0,011
7,9	0,009	0,009	0,010	0,010	0,010	0,010	0,010	0,011	0,011	0,011	0,011
8,1	0,010	0,010	0,010	0,010	0,010	0,010	0,010	0,011	0,011	0,011	0,011
8,3	0,013	0,013	0,013	0,013	0,013	0,013	0,013	0,014	0,014	0,014	0,014
8,5	0,012	0,013	0,013	0,013	0,013	0,013	0,013	0,014	0,014	0,014	0,014
8,7	0,009	0,009	0,009	0,009	0,009	0,009	0,009	0,010	0,010	0,011	0,010
8,9	0,008	0,009	0,009	0,009	0,009	0,009	0,009	0,010	0,010	0,011	0,011

Harmonic: HYD 20KTL-3PH											
P/P _n [%]	0	10	20	30	40	50	60	70	80	90	100
Order	I [%]	I [%]	I [%]	I [%]	I [%]	I [%]	I [%]	I [%]	I [%]	I [%]	I [%]
1	5,447	10,35	20,31	30,46	40,27	50,25	60,21	70,31	80,18	90,10	100,53
2	0,198	0,178	0,162	0,158	0,163	0,154	0,155	0,155	0,159	0,171	0,310
3	0,191	0,156	0,150	0,158	0,164	0,166	0,168	0,171	0,178	0,189	0,334
4	0,121	0,129	0,129	0,132	0,225	0,134	0,132	0,131	0,129	0,122	0,258
5	0,248	0,469	0,512	0,506	0,505	0,505	0,505	0,516	0,538	0,557	0,714
6	0,138	0,102	0,101	0,100	0,101	0,104	0,105	0,106	0,106	0,113	0,239
7	0,267	0,271	0,368	0,353	0,332	0,314	0,296	0,282	0,264	0,249	0,334
8	0,098	0,062	0,063	0,059	0,063	0,062	0,063	0,064	0,068	0,079	0,152
9	0,024	0,024	0,025	0,026	0,027	0,033	0,036	0,035	0,041	0,057	0,074
10	0,109	0,041	0,037	0,032	0,034	0,031	0,031	0,031	0,026	0,020	0,080
11	0,294	0,266	0,254	0,199	0,162	0,119	0,083	0,065	0,066	0,077	0,105
12	0,078	0,033	0,013	0,015	0,016	0,017	0,019	0,020	0,024	0,034	0,082
13	0,222	0,259	0,188	0,180	0,167	0,149	0,124	0,105	0,105	0,116	0,232
14	0,065	0,020	0,016	0,012	0,014	0,012	0,011	0,012	0,013	0,019	0,027
15	0,069	0,026	0,023	0,024	0,020	0,021	0,023	0,025	0,025	0,022	0,096
16	0,102	0,024	0,012	0,009	0,011	0,008	0,009	0,008	0,009	0,012	0,018
17	0,060	0,283	0,147	0,098	0,130	0,108	0,084	0,070	0,073	0,088	0,204
18	0,088	0,026	0,009	0,008	0,007	0,008	0,009	0,009	0,012	0,015	0,019
19	0,059	0,227	0,129	0,068	0,099	0,072	0,050	0,044	0,054	0,072	0,061
20	0,069	0,021	0,009	0,009	0,009	0,007	0,008	0,007	0,008	0,010	0,017
21	0,061	0,025	0,022	0,022	0,019	0,020	0,019	0,019	0,020	0,020	0,077
22	0,081	0,018	0,008	0,007	0,008	0,006	0,006	0,006	0,007	0,009	0,011
23	0,061	0,112	0,137	0,024	0,078	0,048	0,035	0,047	0,077	0,092	0,068
24	0,060	0,017	0,008	0,006	0,005	0,006	0,007	0,007	0,008	0,009	0,016
25	0,064	0,067	0,121	0,030	0,114	0,102	0,088	0,075	0,076	0,087	0,339
26	0,038	0,017	0,011	0,007	0,007	0,005	0,006	0,006	0,006	0,006	0,011
27	0,038	0,017	0,016	0,019	0,022	0,025	0,022	0,019	0,018	0,016	0,213
28	0,036	0,015	0,009	0,006	0,007	0,006	0,006	0,006	0,006	0,007	0,021
29	0,039	0,013	0,105	0,066	0,116	0,108	0,090	0,083	0,092	0,097	0,418
30	0,019	0,014	0,009	0,007	0,006	0,006	0,007	0,006	0,007	0,007	0,025
31	0,046	0,043	0,065	0,136	0,148	0,070	0,036	0,066	0,084	0,100	0,387
32	0,017	0,016	0,010	0,006	0,009	0,008	0,009	0,007	0,007	0,007	0,032
33	0,033	0,073	0,061	0,065	0,042	0,030	0,035	0,034	0,030	0,027	0,215
34	0,014	0,011	0,009	0,007	0,008	0,008	0,010	0,009	0,009	0,008	0,024
35	0,096	0,060	0,075	0,149	0,149	0,085	0,038	0,069	0,099	0,111	0,253
36	0,009	0,010	0,006	0,005	0,008	0,009	0,009	0,011	0,012	0,011	0,014
37	0,095	0,032	0,043	0,076	0,053	0,024	0,073	0,177	0,305	0,265	0,021
38	0,011	0,013	0,007	0,005	0,005	0,006	0,009	0,009	0,010	0,011	0,014
39	0,018	0,012	0,014	0,016	0,018	0,020	0,021	0,038	0,047	0,043	0,056
40	0,020	0,012	0,008	0,006	0,006	0,006	0,007	0,011	0,014	0,015	0,011

Interharmonics: HYD 20KTL-3PH											
P/P _n [%]	0	10	20	30	40	50	60	70	80	90	100
f [Hz]	I [%]	I [%]	I [%]	I [%]	I [%]	I [%]	I [%]	I [%]	I [%]	I [%]	I [%]
75	0,090	0,102	0,065	0,067	0,067	0,067	0,066	0,065	0,066	0,068	0,110
125	0,054	0,071	0,052	0,055	0,057	0,053	0,053	0,052	0,053	0,054	0,099
175	0,042	0,040	0,033	0,036	0,048	0,037	0,039	0,039	0,042	0,044	0,085
225	0,054	0,036	0,023	0,025	0,044	0,027	0,028	0,029	0,031	0,033	0,060
275	0,041	0,031	0,020	0,020	0,022	0,020	0,022	0,023	0,024	0,026	0,045
325	0,036	0,028	0,016	0,015	0,016	0,016	0,017	0,018	0,019	0,021	0,038
375	0,033	0,025	0,013	0,013	0,013	0,013	0,014	0,015	0,016	0,017	0,026
425	0,021	0,016	0,011	0,011	0,012	0,011	0,012	0,012	0,013	0,015	0,022
475	0,019	0,015	0,010	0,009	0,010	0,009	0,010	0,011	0,012	0,013	0,019
525	0,027	0,021	0,009	0,009	0,009	0,009	0,009	0,010	0,011	0,012	0,017
575	0,028	0,019	0,009	0,009	0,008	0,008	0,009	0,009	0,010	0,010	0,020
625	0,021	0,020	0,008	0,008	0,008	0,008	0,008	0,008	0,009	0,010	0,036
675	0,023	0,016	0,008	0,008	0,008	0,007	0,008	0,008	0,008	0,009	0,014
725	0,015	0,011	0,007	0,007	0,007	0,007	0,007	0,007	0,008	0,008	0,013
775	0,013	0,011	0,006	0,006	0,007	0,006	0,007	0,007	0,007	0,008	0,012
825	0,016	0,016	0,007	0,006	0,006	0,006	0,006	0,007	0,007	0,008	0,012
875	0,016	0,014	0,006	0,006	0,006	0,006	0,006	0,006	0,007	0,007	0,012
925	0,014	0,015	0,007	0,007	0,007	0,007	0,007	0,007	0,007	0,008	0,015
975	0,014	0,012	0,006	0,006	0,006	0,006	0,006	0,006	0,006	0,007	0,011
1025	0,012	0,010	0,006	0,006	0,006	0,006	0,007	0,007	0,007	0,007	0,013
1075	0,010	0,008	0,005	0,005	0,005	0,005	0,006	0,006	0,006	0,006	0,011
1125	0,012	0,011	0,005	0,005	0,005	0,005	0,006	0,006	0,006	0,006	0,011
1175	0,012	0,010	0,006	0,005	0,005	0,005	0,006	0,006	0,006	0,006	0,011
1225	0,011	0,009	0,005	0,005	0,005	0,005	0,006	0,006	0,006	0,006	0,014
1275	0,011	0,009	0,006	0,005	0,005	0,006	0,006	0,006	0,006	0,006	0,012
1325	0,011	0,009	0,007	0,007	0,007	0,007	0,007	0,007	0,007	0,008	0,017
1375	0,009	0,007	0,005	0,005	0,006	0,006	0,006	0,006	0,006	0,006	0,015
1425	0,011	0,009	0,007	0,007	0,007	0,007	0,008	0,008	0,008	0,008	0,023
1475	0,008	0,008	0,006	0,006	0,006	0,006	0,006	0,006	0,006	0,007	0,018
1525	0,008	0,007	0,006	0,006	0,006	0,006	0,006	0,006	0,007	0,007	0,021
1575	0,008	0,008	0,006	0,006	0,007	0,007	0,007	0,007	0,007	0,007	0,019
1625	0,009	0,009	0,007	0,007	0,007	0,008	0,008	0,009	0,009	0,009	0,022
1675	0,007	0,007	0,006	0,006	0,006	0,006	0,007	0,008	0,007	0,008	0,017
1725	0,007	0,007	0,006	0,006	0,006	0,006	0,007	0,008	0,008	0,008	0,016
1775	0,007	0,007	0,006	0,006	0,006	0,007	0,007	0,008	0,009	0,008	0,017
1825	0,008	0,007	0,006	0,006	0,006	0,007	0,007	0,008	0,010	0,009	0,021
1875	0,008	0,007	0,006	0,006	0,006	0,006	0,007	0,008	0,009	0,010	0,020
1925	0,009	0,008	0,007	0,007	0,007	0,007	0,007	0,008	0,009	0,010	0,017
1975	0,008	0,007	0,007	0,007	0,007	0,007	0,007	0,008	0,009	0,010	0,014

Higher Frequencies: HYD 20KTL-3PH											
P/P _n [%]	0	10	20	30	40	50	60	70	80	90	100
f [kHz]	I [%]	I [%]	I [%]	I [%]	I [%]	I [%]	I [%]	I [%]	I [%]	I [%]	I [%]
2,1	0,079	0,051	0,031	0,095	0,066	0,059	0,099	0,200	0,346	0,317	0,103
2,3	0,073	0,090	0,073	0,089	0,071	0,066	0,075	0,080	0,104	0,138	0,150
2,5	0,077	0,103	0,080	0,095	0,081	0,066	0,061	0,065	0,071	0,087	0,130
2,7	0,074	0,109	0,091	0,094	0,077	0,053	0,052	0,066	0,079	0,093	0,107
2,9	0,058	0,062	0,058	0,052	0,069	0,055	0,059	0,065	0,070	0,072	0,129
3,1	0,054	0,059	0,059	0,055	0,078	0,071	0,064	0,073	0,085	0,102	0,149
3,3	0,057	0,060	0,069	0,063	0,083	0,080	0,081	0,091	0,103	0,118	0,194
3,5	0,049	0,053	0,058	0,058	0,066	0,075	0,083	0,092	0,103	0,101	0,159
3,7	0,043	0,046	0,048	0,049	0,053	0,056	0,059	0,060	0,063	0,067	0,116
3,9	0,028	0,031	0,031	0,032	0,034	0,035	0,035	0,036	0,037	0,040	0,072
4,1	0,022	0,023	0,024	0,025	0,026	0,027	0,028	0,028	0,029	0,029	0,056
4,3	0,019	0,020	0,021	0,021	0,022	0,023	0,023	0,023	0,024	0,024	0,047
4,5	0,016	0,017	0,018	0,018	0,019	0,019	0,020	0,020	0,020	0,020	0,040
4,7	0,029	0,030	0,030	0,031	0,031	0,031	0,032	0,032	0,032	0,032	0,064
4,9	0,013	0,013	0,014	0,015	0,015	0,015	0,016	0,016	0,016	0,016	0,031
5,1	0,012	0,013	0,013	0,014	0,014	0,014	0,015	0,015	0,015	0,015	0,029
5,3	0,011	0,011	0,012	0,012	0,013	0,013	0,013	0,013	0,014	0,014	0,026
5,5	0,010	0,011	0,011	0,011	0,012	0,012	0,012	0,012	0,013	0,013	0,024
5,7	0,010	0,011	0,011	0,011	0,012	0,012	0,012	0,012	0,013	0,013	0,024
5,9	0,009	0,009	0,010	0,010	0,010	0,010	0,011	0,011	0,011	0,012	0,021
6,1	0,012	0,012	0,012	0,012	0,013	0,013	0,013	0,013	0,014	0,014	0,026
6,3	0,008	0,009	0,009	0,009	0,009	0,010	0,010	0,010	0,011	0,011	0,019
6,5	0,008	0,008	0,009	0,009	0,009	0,009	0,009	0,010	0,010	0,011	0,019
6,7	0,008	0,008	0,008	0,009	0,009	0,009	0,009	0,009	0,010	0,010	0,018
6,9	0,008	0,008	0,008	0,008	0,008	0,009	0,009	0,009	0,009	0,010	0,018
7,1	0,014	0,014	0,014	0,014	0,014	0,014	0,075	0,014	0,014	0,015	0,029
7,3	0,008	0,008	0,008	0,008	0,008	0,008	0,061	0,009	0,009	0,009	0,017
7,5	0,007	0,007	0,008	0,008	0,008	0,008	0,052	0,008	0,008	0,009	0,017
7,7	0,007	0,007	0,007	0,008	0,008	0,008	0,059	0,008	0,008	0,009	0,016
7,9	0,007	0,007	0,007	0,007	0,008	0,008	0,064	0,008	0,008	0,009	0,016
8,1	0,007	0,007	0,007	0,008	0,008	0,008	0,081	0,008	0,008	0,008	0,017
8,3	0,010	0,010	0,010	0,010	0,010	0,010	0,083	0,010	0,011	0,011	0,021
8,5	0,009	0,010	0,010	0,010	0,010	0,010	0,059	0,011	0,011	0,011	0,022
8,7	0,007	0,007	0,007	0,007	0,007	0,007	0,035	0,008	0,008	0,008	0,015
8,9	0,006	0,007	0,007	0,007	0,007	0,007	0,028	0,008	0,008	0,008	0,015

Note:

The normalization current is 7,25A for HYD 5KTL-3PH;
 The normalization current is 8,69A for HYD 6KTL-3PH;
 The normalization current is 11,59A for HYD 8KTL-3PH;
 The normalization current is 14,49A for HYD 10KTL-3PH;
 The normalization current is 21,74A for HYD 15KTL-3PH;
 The normalization current is 28,99A for HYD 20KTL-3PH;
 The stated harmonics are maximum values of all 3 phases ,
 The test results refer to the test report "PV200302N015-6" issued by Bureau Veritas Shenzhen Co., Ltd.
 Dongguan Branch, dated on 2020.08.21.

4.8 EMC and power quality Switching operation (Refer IEC 61400-21)		P			
Test result: HYD 20KTL-3PH					
Max. number of switching operations, N_{10}	10				
Max. number of switching operations, N_{120}	120				
Case of switching operation		Cut-in at 9% $P_{E_{max}}$			
Grid impedance angle, ψ_k	30°	50°	70°	85°	
Flicker step factor, $k_f(\psi_k)$	0,094	0,061	0,050	0,047	
Voltage change factor, $k_u(\psi_k)$	0,388	0,388	0,388	0,388	
Maximum inrush current factor k_{imax}	0,080				
Case of switching operation		Cut-in at 100% $P_{E_{max}}$			
Grid impedance angle, ψ_k	30°	50°	70°	85°	
Flicker step factor, $k_f(\psi_k)$	0,145	0,095	0,077	0,073	
Voltage change factor, $k_u(\psi_k)$	2,206	2,206	2,206	2,206	
Maximum inrush current factor k_{imax}	0,565				
Case of switching operation		Service disconnection at rated power			
Grid impedance angle, ψ_k	30°	50°	70°	85°	
Flicker step factor, $k_f(\psi_k)$	0,114	0,074	0,061	0,057	
Voltage change factor, $k_u(\psi_k)$	2,318	2,318	2,318	2,318	
Maximum inrush current factor k_{imax}	0,555				
Worst case over all switching operations, k_{imax}	0,565				
Note:					
$S_{k, fic}/S_n$ in the fictitious grid was set to:20.					
The tests had been performed on the HYD 20KTL-3PH is valid for the HYD 15KTL-3PH, HYD 10KTL-3PH, HYD 8KTL-3PH, HYD 6KTL-3PH and HYD 5KTL-3PH since it is similar in hardware and just power derated by software.					
The test results refer to the test report "20TH0332-CEI0-16_2" issued by Bureau Veritas Consumer Products Services Germany GmbH, dated on 2020.07.22.					

4.8 Voltage fluctuation and flicker					P
Test result:					
Test conditions:		Maximum permissible voltage fluctuation (expressed as a percentage of nominal voltage at 100 % power) and flicker as per EN 61000-3-3 and/or EN 61000-3-11.			
Test:					
Value	P_{st}	P_{lt} 2 hours	d(t)_{500ms}	d_c	d_{max}
Limit	1,0	0,65	3,3%	3,3%	4%
Test value	See below				
inverter <16A (HYD 5KTL-3PH)					
L1 phase					
	dc[%]	dmax[%]	d(t)[ms]	Pst	Plt
Limit	3.30	4.00	500 3.30%	1.00	0.65 N:12
No. 1	0.114 <i>Pass</i>	0.159 <i>Pass</i>	0.0 <i>Pass</i>	0.044 <i>Pass</i>	
2	0.068 <i>Pass</i>	0.109 <i>Pass</i>	0.0 <i>Pass</i>	0.037 <i>Pass</i>	
3	0.092 <i>Pass</i>	0.132 <i>Pass</i>	0.0 <i>Pass</i>	0.027 <i>Pass</i>	
4	0.017 <i>Pass</i>	0.165 <i>Pass</i>	0.0 <i>Pass</i>	0.033 <i>Pass</i>	
5	0.098 <i>Pass</i>	0.213 <i>Pass</i>	0.0 <i>Pass</i>	0.025 <i>Pass</i>	
6	0.071 <i>Pass</i>	0.133 <i>Pass</i>	0.0 <i>Pass</i>	0.025 <i>Pass</i>	
7	0.078 <i>Pass</i>	0.171 <i>Pass</i>	0.0 <i>Pass</i>	0.026 <i>Pass</i>	
8	0.104 <i>Pass</i>	0.199 <i>Pass</i>	0.0 <i>Pass</i>	0.032 <i>Pass</i>	
9	0.036 <i>Pass</i>	0.151 <i>Pass</i>	0.0 <i>Pass</i>	0.027 <i>Pass</i>	
10	0.095 <i>Pass</i>	0.152 <i>Pass</i>	0.0 <i>Pass</i>	0.028 <i>Pass</i>	
11	0.081 <i>Pass</i>	0.146 <i>Pass</i>	0.0 <i>Pass</i>	0.030 <i>Pass</i>	
12	0.090 <i>Pass</i>	0.144 <i>Pass</i>	0.0 <i>Pass</i>	0.033 <i>Pass</i>	
Result	<i>Pass</i>	<i>Pass</i>	<i>Pass</i>	<i>Pass</i>	0.032 <i>Pass</i>
L2 phase					
	dc[%]	dmax[%]	d(t)[ms]	Pst	Plt
Limit	3.30	4.00	500 3.30%	1.00	0.65 N:12
No. 1	0.010 <i>Pass</i>	0.119 <i>Pass</i>	0.0 <i>Pass</i>	0.139 <i>Pass</i>	
2	0.007 <i>Pass</i>	0.111 <i>Pass</i>	0.0 <i>Pass</i>	0.138 <i>Pass</i>	
3	0.006 <i>Pass</i>	0.114 <i>Pass</i>	0.0 <i>Pass</i>	0.137 <i>Pass</i>	
4	0.000 <i>Pass</i>	0.000 <i>Pass</i>	0.0 <i>Pass</i>	0.136 <i>Pass</i>	
5	0.007 <i>Pass</i>	0.104 <i>Pass</i>	0.0 <i>Pass</i>	0.136 <i>Pass</i>	
6	0.009 <i>Pass</i>	0.103 <i>Pass</i>	0.0 <i>Pass</i>	0.137 <i>Pass</i>	
7	0.000 <i>Pass</i>	0.000 <i>Pass</i>	0.0 <i>Pass</i>	0.136 <i>Pass</i>	
8	0.006 <i>Pass</i>	0.105 <i>Pass</i>	0.0 <i>Pass</i>	0.137 <i>Pass</i>	
9	0.000 <i>Pass</i>	0.000 <i>Pass</i>	0.0 <i>Pass</i>	0.137 <i>Pass</i>	
10	0.011 <i>Pass</i>	0.104 <i>Pass</i>	0.0 <i>Pass</i>	0.136 <i>Pass</i>	
11	0.010 <i>Pass</i>	0.119 <i>Pass</i>	0.0 <i>Pass</i>	0.137 <i>Pass</i>	
12	0.000 <i>Pass</i>	0.000 <i>Pass</i>	0.0 <i>Pass</i>	0.137 <i>Pass</i>	
Result	<i>Pass</i>	<i>Pass</i>	<i>Pass</i>	<i>Pass</i>	0.137 <i>Pass</i>

L3 phase

	dc[%]	dmax[%]	d(t)[ms]	Pst	Plt
Limit	3.30	4.00	500 3.30%	1.00	0.65 N:12
No. 1	0.000 Pass	0.000 Pass	0.0 Pass	0.048 Pass	
2	0.000 Pass	0.000 Pass	0.0 Pass	0.047 Pass	
3	0.013 Pass	0.101 Pass	0.0 Pass	0.046 Pass	
4	0.009 Pass	0.101 Pass	0.0 Pass	0.045 Pass	
5	0.000 Pass	0.000 Pass	0.0 Pass	0.046 Pass	
6	0.000 Pass	0.000 Pass	0.0 Pass	0.046 Pass	
7	0.000 Pass	0.000 Pass	0.0 Pass	0.046 Pass	
8	0.000 Pass	0.000 Pass	0.0 Pass	0.046 Pass	
9	0.000 Pass	0.000 Pass	0.0 Pass	0.046 Pass	
10	0.020 Pass	0.108 Pass	0.0 Pass	0.046 Pass	
11	0.000 Pass	0.000 Pass	0.0 Pass	0.047 Pass	
12	0.000 Pass	0.000 Pass	0.0 Pass	0.047 Pass	
Result	Pass	Pass	Pass	Pass	0.046 Pass

Inverter >16A (HYD 20KTL-3PH)

L1 phase

	dc[%]	dmax[%]	d(t)[ms]	Pst	Plt
Limit	3.30	4.00	500 3.30%	1.00	0.65 N:12
No. 1	0.108 Pass	0.149 Pass	0.0 Pass	0.040 Pass	
2	0.109 Pass	0.191 Pass	0.0 Pass	0.043 Pass	
3	0.107 Pass	0.183 Pass	0.0 Pass	0.047 Pass	
4	0.114 Pass	0.279 Pass	0.0 Pass	0.056 Pass	
5	0.109 Pass	0.137 Pass	0.0 Pass	0.057 Pass	
6	0.108 Pass	0.138 Pass	0.0 Pass	0.056 Pass	
7	0.095 Pass	0.139 Pass	0.0 Pass	0.056 Pass	
8	0.100 Pass	0.155 Pass	0.0 Pass	0.056 Pass	
9	0.105 Pass	0.145 Pass	0.0 Pass	0.056 Pass	
10	0.109 Pass	0.135 Pass	0.0 Pass	0.056 Pass	
11	0.105 Pass	0.133 Pass	0.0 Pass	0.056 Pass	
12	0.095 Pass	0.172 Pass	0.0 Pass	0.056 Pass	
Result	Pass	Pass	Pass	Pass	0.054 Pass

L2 phase

	dc[%]	dmax[%]	d(t)[ms]	Pst	Plt
Limit	3.30	4.00	500 3.30%	1.00	0.65 N:12
No. 1	0.016 Pass	0.101 Pass	0.0 Pass	0.136 Pass	
2	0.000 Pass	0.000 Pass	0.0 Pass	0.136 Pass	
3	0.015 Pass	0.116 Pass	0.0 Pass	0.137 Pass	
4	0.009 Pass	0.102 Pass	0.0 Pass	0.136 Pass	
5	0.000 Pass	0.000 Pass	0.0 Pass	0.136 Pass	
6	0.003 Pass	0.101 Pass	0.0 Pass	0.135 Pass	
7	0.000 Pass	0.000 Pass	0.0 Pass	0.135 Pass	
8	0.000 Pass	0.000 Pass	0.0 Pass	0.135 Pass	
9	0.008 Pass	0.119 Pass	0.0 Pass	0.135 Pass	
10	0.000 Pass	0.000 Pass	0.0 Pass	0.135 Pass	
11	0.027 Pass	0.112 Pass	0.0 Pass	0.136 Pass	
12	0.024 Pass	0.132 Pass	0.0 Pass	0.135 Pass	
Result	Pass	Pass	Pass	Pass	0.136 Pass

L3 phase

	dc[%]	dmax[%]	d(t)[ms]	Pst	Plt
Limit	3.30	4.00	500 3.30%	1.00	0.65 N:12
No. 1	0.000 Pass	0.000 Pass	0.0 Pass	0.044 Pass	
2	0.000 Pass	0.000 Pass	0.0 Pass	0.044 Pass	
3	0.000 Pass	0.000 Pass	0.0 Pass	0.044 Pass	
4	0.000 Pass	0.000 Pass	0.0 Pass	0.044 Pass	
5	0.000 Pass	0.000 Pass	0.0 Pass	0.043 Pass	
6	0.000 Pass	0.000 Pass	0.0 Pass	0.042 Pass	
7	0.000 Pass	0.000 Pass	0.0 Pass	0.042 Pass	
8	0.000 Pass	0.000 Pass	0.0 Pass	0.042 Pass	
9	0.000 Pass	0.000 Pass	0.0 Pass	0.042 Pass	
10	0.000 Pass	0.000 Pass	0.0 Pass	0.042 Pass	
11	0.000 Pass	0.000 Pass	0.0 Pass	0.043 Pass	
12	0.000 Pass	0.000 Pass	0.0 Pass	0.042 Pass	
Result	Pass	Pass	Pass	Pass	0.043 Pass

Note:

*The stationary deviance of dc% is more relevant than the dynamic deviance of dmax at starting and stopping, Mains Impedance according EN61000-3-11:

$R_{max} = 0,24\Omega$; $jX_{max} = 0,15\Omega$ @50Hz ($|Z_{max}| = 0,283/0,4717\Omega$) for single phase inverter use also $R_n = 0,16\Omega$; $jX_n = 0,1\Omega$.

Calculation of the maximum permissible grid impedance at the point of common coupling based on dc:

$Z_{max} = Z_{ref} * 3,3\% / d_c(P_n)$.

The tests should be based on the limits of the EN 61000-3-3 for less than 16A and on EN 61000-3-11 for more than 16A.

The tests had been performed on the HYD 20KTL-3PH and HYD 5KTL-3PH is valid for the HYD 15KTL-3PH, HYD 10KTL-3PH, HYD 8KTL-3PH and HYD 6KTL-3PH since it is similar in hardware and just power derated by software.

The test results refer to the test report "PV200302N015-6" issued by Bureau Veritas Shenzhen Co., Ltd. Dongguan Branch, dated on 2020.08.21.

4.8 EMC and power quality Flicker and voltage fluctuations					P
Method: Measurement and evaluation was carried out according to the procedure in IEC 61400-21.					
Test result:					
HYD 5KTL-3PH					
Grid impedance angle, ψ_k	30°	50°	70°	85°	
Flicker coefficient, $c(\psi_k)$	3,260	2.140	1.740	1,640	
Short-term flicker, P_{st}	0,163	0,107	0,087	0,082	
HYD 10KTL-3PH					
Grid impedance angle, ψ_k	30°	50°	70°	85°	
Flicker coefficient, $c(\psi_k)$	2,960	1,940	,58	1,480	
Short-term flicker, P_{st}	0,148	0,097	0,079	0,074	
HYD 20KTL-3PH					
Grid impedance angle, ψ_k	30°	50°	70°	85°	
Flicker coefficient, $c(\psi_k)$	2,540	1,660	1,360	1,280	
Short-term flicker, P_{st}	0,127	0,083	0,068	0,064	
Note:					
The table entries are worst case values.					
$S_{k, fic}/S_n$ in the fictitious grid was set to: 20					
The test results refer to the test report "20TH0332-CEI0-16_2" issued by Bureau Veritas Consumer Products Services Germany GmbH, dated on 2020.07.22.					

4.8 EMC and power quality DC-Injection		P			
Test result: HYD 5KTL-3PH					
Protection limit	Tested at four power levels limit 0,5% of I _{AC;nom} (36mA)				
Output power	~20%	~50%	75%	~100%	
Abs. Max. Test Value:L1 [mA]	7,7	8,9	12,0	13,8	
Abs. Ave. Test Value:L1 [mA]	4,2	3,9	4,1	4,0	
Abs. Max. Test Value:L2 [mA]	4,4	6,5	11,5	15,3	
Abs. Ave. Test Value:L2 [mA]	0,1	0,5	0,8	1,0	
Abs. Max. Test Value:L3 [mA]	10,0	12,2	13,0	15,7	
Abs. Ave. Test Value:L3 [mA]	5,0	5,0	5,1	5,6	
Test result: HYD 20KTL-3PH					
Protection limit	Tested at four power levels limit 0,5% of I _{AC;nom} (145mA)				
Output power	~20%	~50%	75%	~100%	
Abs. Max. Test Value:L1 [mA]	27,0	37,5	45,7	54,7	
Abs. Ave. Test Value:L1 [mA]	16,8	16,7	13,2	15,8	
Abs. Max. Test Value:L2 [mA]	18,7	36,6	53,8	69,7	
Abs. Ave. Test Value:L2 [mA]	2,8	3,0	3,4	3,4	
Abs. Max. Test Value:L3 [mA]	33,7	47,4	59,7	71,3	
Abs. Ave. Test Value:L3 [mA]	22,1	23,3	23,9	23,4	
Note:					
Test method and setting value refer Annex D.3.10 of EN 50438:2013.					
The tests had been performed on the HYD 20KTL-3PH and HYD 5KTL-3PH is valid for the HYD 15KTL-3PH, HYD 10KTL-3PH, HYD 8KTL-3PH and HYD 6KTL-3PH since it is similar in hardware and just power derated by software.					
The test results refer to the test report "PV200302N015-6" issued by Bureau Veritas Shenzhen Co., Ltd. Dongguan Branch, dated on 2020.08.21.					

Diagram of permanent dc-injection of HYD 5KTL-3PH

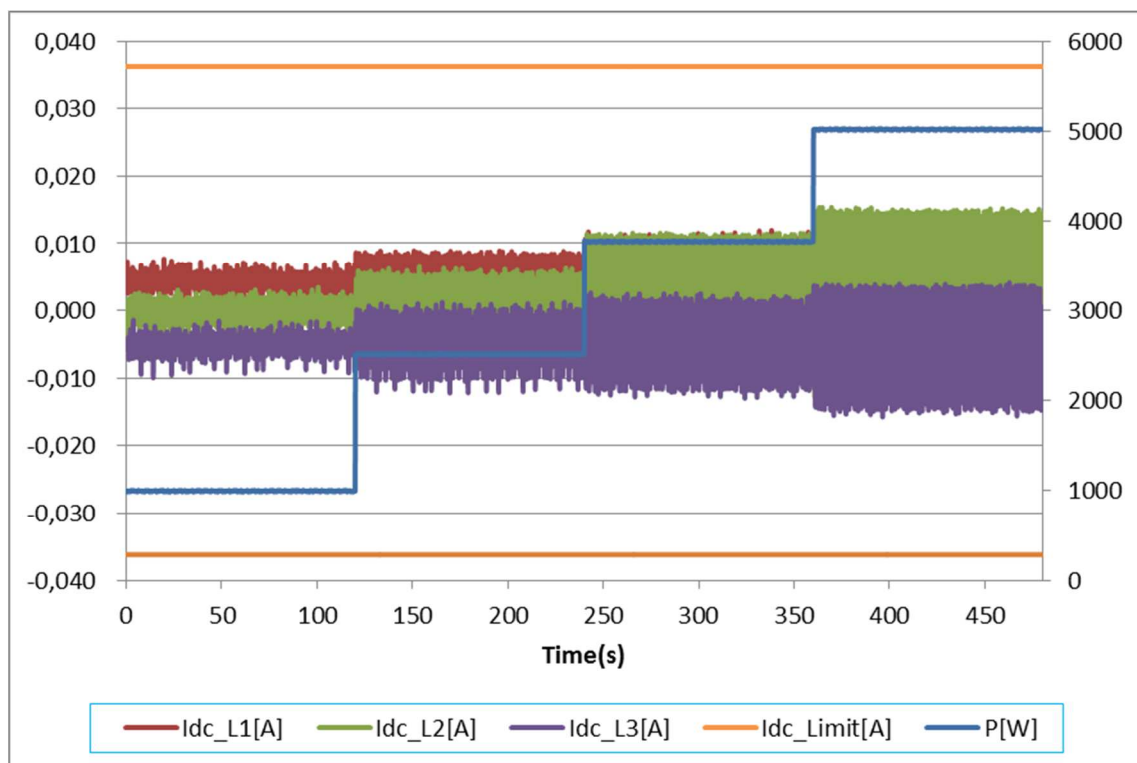
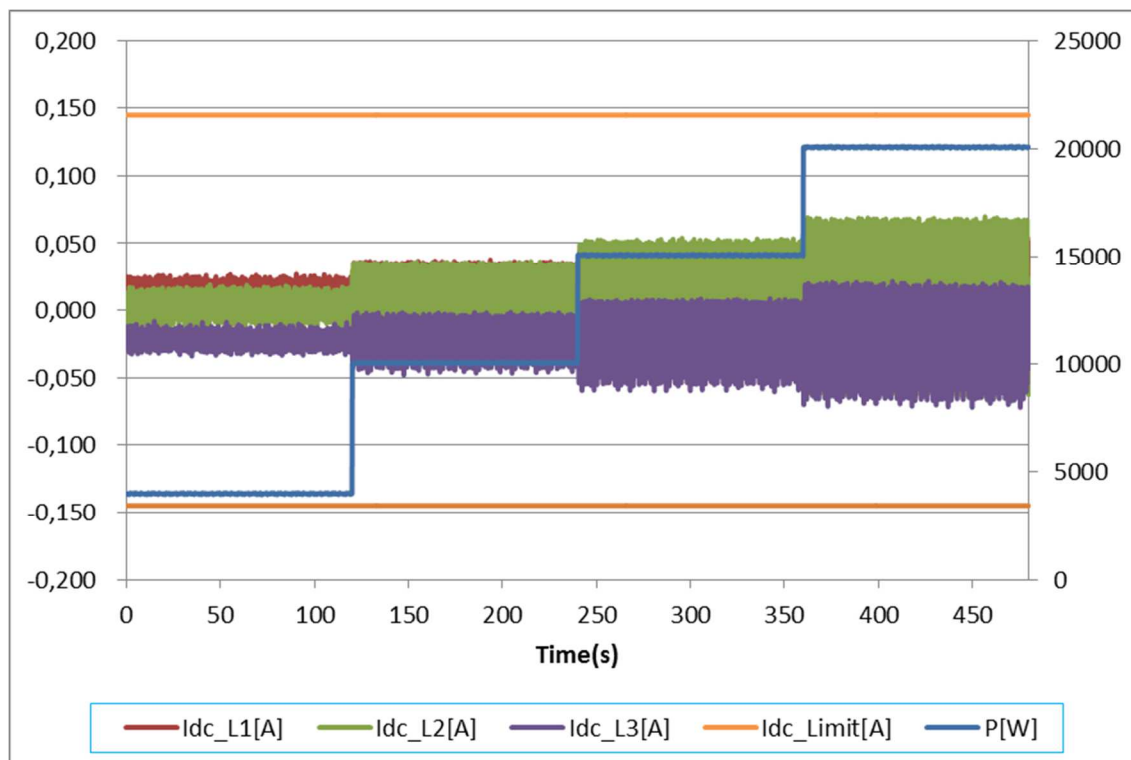

Diagram of permanent dc-injection of HYD 20KTL-3PH



4.8 Immunity to voltage dips and short interruptions					P
For a directly coupled SSEG			For a Inverter SSEG		
L1 phase					
Parameter	Symbol	Value	Time after fault	Volts	Amps
Peak Short Circuit current	I_p	N/A	20ms	40,32	4,993
Initial Value of aperiodic current	A	N/A	100ms	28,71	5,001
Initial symmetrical short-circuit current*	I_k	N/A	250ms	26.48	5,002
Decaying (aperiodic) component of short circuit current*	i_{DC}	N/A	500ms	N/A	N/A
Reactance/Resistance Ratio of source*	X/R	N/A	Time to trip	159ms	In seconds
L2 phase					
Parameter	Symbol	Value	Time after fault	Volts	Amps
Peak Short Circuit current	I_p	N/A	20ms	29,43	4,992
Initial Value of aperiodic current	A	N/A	100ms	25,91	5,000
Initial symmetrical short-circuit current*	I_k	N/A	250ms	28,85	5,002
Decaying (aperiodic) component of short circuit current*	i_{DC}	N/A	500ms	N/A	N/A
Reactance/Resistance Ratio of source*	X/R	N/A	Time to trip	152ms	In seconds
L3 phase					
Parameter	Symbol	Value	Time after fault	Volts	Amps
Peak Short Circuit current	I_p	N/A	20ms	44,93	4,993
Initial Value of aperiodic current	A	N/A	100ms	30,04	5,000
Initial symmetrical short-circuit current*	I_k	N/A	250ms	25,14	5,002
Decaying (aperiodic) component of short circuit current*	i_{DC}	N/A	500ms	N/A	N/A
Reactance/Resistance Ratio of source*	X/R	N/A	Time to trip	172	In seconds

Diagram



Note:

For rotating machines and linear piston machines the test should produce a 0s – 2s plot of the short circuit current as seen at the Generating Unit terminals.

* Values for these parameters should be provided where the short circuit duration is sufficiently long to enable interpolation of the plot.

The tests had been performed on the HYD 20KTL-3PH is valid for the HYD 15KTL-3PH, HYD 10KTL-3PH, HYD 8KTL-3PH, HYD 6KTL-3PH and HYD 5KTL-3PH since it is similar in hardware and just power derated by software.

The test results refer to the test report "PV200302N015-6" issued by Bureau Veritas Shenzhen Co., Ltd. Dongguan Branch, dated on 2020.08.21.

4.8 Unbalance								P
Test: cos φ = 1								
P [%P _{max}]	P* [kW]	U _{1+*} [V]	U _{1-*} [V]	I _{1+*} [A]	I _{1-*} [A]	U _{i*} [% I ₁₊]	U _{i abs*} [% I _n]	Number of data sets
0 - 5	0,526	229,87	0,12	0,763	0,017	2,263	0,060	3
10	1,930	229,87	0,13	2,798	0,023	0,814	0,079	3
20	3,952	229,88	0,13	5,730	0,027	0,475	0,094	3
30	5,982	229,91	0,12	8,673	0,028	0,320	0,096	3
40	8,000	229,96	0,13	11,596	0,031	0,269	0,108	3
50	11,011	230,00	0,15	14,508	0,049	0,339	0,170	3
60	12,005	229,97	0,24	17,400	0,091	0,522	0,313	3
70	14,033	230,02	0,28	20,335	0,110	0,541	0,380	3
80	16,034	230,05	0,24	0,023	0,091	0,393	0,315	3
90	18,026	230,08	0,16	26,114	0,063	0,242	0,218	3
100	20,000	230,08	0,15	28,975	0,059	0,203	0,203	3
Maximum unsymmetry U _{imax} (≥10%P _n)					0,541			
<p>Note:</p> <p>*1 min-average values of positive and negative sequence data. The unsymmetry is calculated according to following equation:</p> $u_i = \frac{I_{1-}}{I_{1+}} \cdot 100\%$ <p>Additionally the unsymmetry is calculated relative to nominal current according to following equation:</p> $u_{i abs} = \frac{I_{1-}}{I_n} \cdot 100\%$ <p>The tests had been performed on the HYD 20KTL-3PH is valid for the HYD 15KTL-3PH, HYD 10KTL-3PH, HYD 8KTL-3PH, HYD 6KTL-3PH and HYD 5KTL-3PH since it is similar in hardware and just power derated by software. The test results refer to the test report "PV200302N015-6" issued by Bureau Veritas Shenzhen Co., Ltd. Dongguan Branch, dated on 2020.08.21.</p>								

Diagram

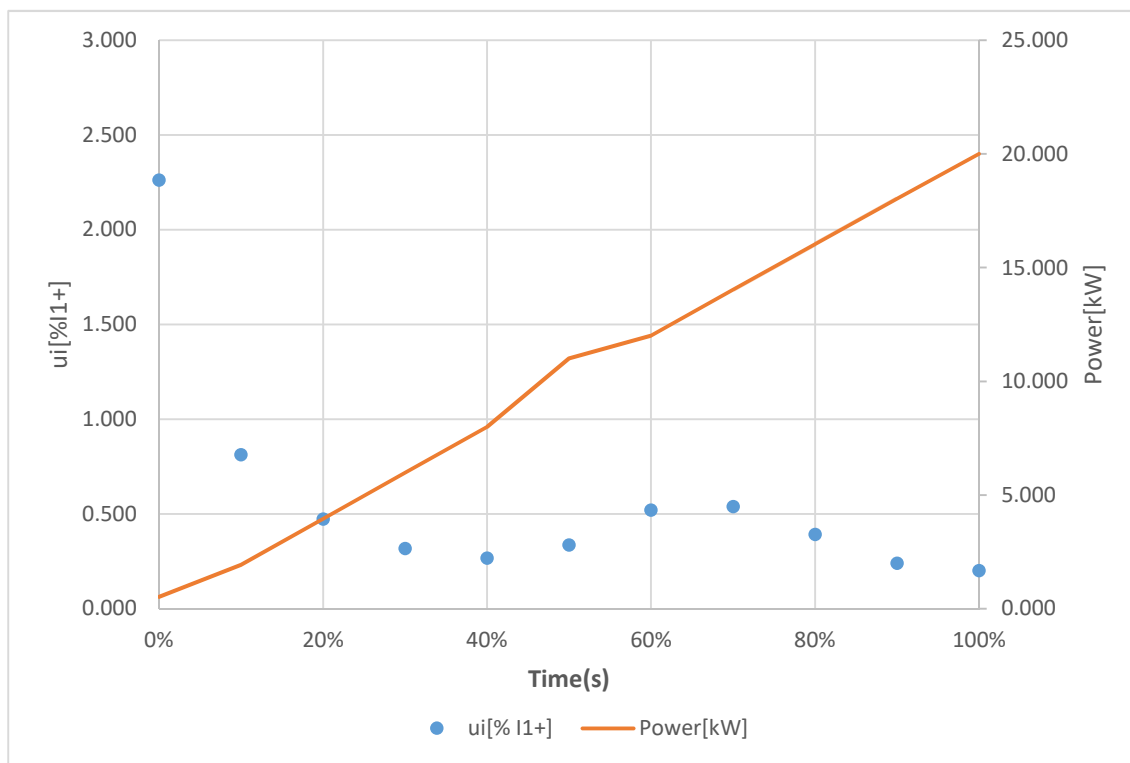

EN 50549-1:2019: Interface protection

Clause	Test requirement	Test procedure according standard	Result
4.9.3	Requirements on voltage and frequency protection	CEI 0-21:2019-04, Annex A.3.1 to A.3.4	P
4.9.3.1	Undervoltage protection	EN 50438, Annex D.2.3	P
	Overvoltage protection	EN 50438, Annex D.2.3	P
	Overvoltage 10 min mean protection	EN 50160	P
	Underfrequency protection	EN 50438, Annex D.2.4	P
	Overfrequency protection	EN 50438, Annex D.2.4	P
4.9.4.2	Loss of Mains (LoM) detection	IEC 62116:2014	P

4.9.3 Requirements on voltage and frequency protection Checklist						P
Several points to check						
Clause 4.9.3.1 to 4.9.3.6	All thresholds must be adjustable					P
Voltage values						
Threshold	Stage 1 [27 <]			Stage 2 [27 <<]		
	Operate voltage	Operate time		Operate voltage	Operate time	
Range	0,2-1,0 U _n	0,1-100s		0,2-1,0 U _n	0,1-5s	
Steps	0,01 U _n	0,1 s		0,01 U _n	0,05s	
Threshold	Stage 1 [59 >]		Stage 2 [59 >>]		Overvoltage 10 min mean protection	
	Operate voltage	Operate time	Operate voltage	Operate time	Operate voltage	Operate time
Range	1,0-1,2 U _n	0,1-100s	1,0-1,3 U _n	0,1-5s	1,0-1,15 U _n	3s not adjustable
Steps	0,01 U _n	0,1s	0,01 U _n	0,05s	0,01 U _n	--
Frequency values						
Threshold	Stage 1 [81 <]			Stage 2 [81 <<]		
	Operate frequency	Operate time		Operate frequency	Operate time	
Range	47,0-50,0Hz	0,1-100s		47,0-50,0Hz	0,1-5s	
Steps	0,1 Hz	0,1 s		0,1 Hz	0,05s	
Threshold	Stage 1 [81 >]			Stage 2 [81 >>]		
	Operate frequency	Operate time		Operate frequency	Operate time	
Range	50,0-52,0Hz	0,1-100s		50,0-52,0Hz	0,1-5s	
Steps	0,1 Hz	0,1 s		0,1 Hz	0,05s	
4.9.2.6	Insensitive against 40ms frequency transients, so that the unit will not trip					P
Note:						
The tests had been performed on the HYD 20KTL-3PH is valid for the HYD 15KTL-3PH, HYD 10KTL-3PH, HYD 8KTL-3PH, HYD 6KTL-3PH and HYD 5KTL-3PH since it is similar in hardware and just power derated by software.						
The test results refer to the test report "PV200302N015-6" issued by Bureau Veritas Shenzhen Co., Ltd. Dongguan Branch, dated on 2020.08.21.						

4.9.3 Requirements on voltage and frequency protection					P	
4.9.3.1 General (Interface protection: Over/under voltage) (Setting value refer EN 50438 for default settings)						
Test conditions			Output power: 10,0kW Frequency: 50+/-0,2Hz			
Phase	Limit [V]	Trip value [V]	Voltage step [V]	Disconnection time [s]	Limit [s]	
L1	110% of Un = 253,0 (stage 1)*	253,51	230,0 to 258,0	2,564	3,0	
		253,58	230,0 to 258,0	2,544		
		253,51	230,0 to 258,0	2,560		
		253,50	230,0 to 258,0	2,540		
		253,51	230,0 to 258,0	2,550		
	115% of Un = 264,5 (stage 2)	264,5	230,0 to 268,0	0,178	0,1 ≤ t ≤ 0,2	
		264,5	230,0 to 268,0	0,176		
		264,4	230,0 to 268,0	0,180		
		264,4	230,0 to 268,0	0,168		
	85% of Un = 195,5	195,3	230,0 to 192,0	1,242	1,2 ≤ t ≤ 1,5	
		195,5	230,0 to 192,0	1,238		
		193,4	230,0 to 192,0	1,254		
		193,4	230,0 to 192,0	1,234		
	L2	110% of Un = 253,0 (stage 1)*	252,1	230,0 to 258,0	2,552	3,0
			252,0	230,0 to 258,0	2,552	
252,1			230,0 to 258,0	2,542		
252,0			230,0 to 258,0	2,548		
252,1			230,0 to 258,0	2,556		
115% of Un = 264,5 (stage 2)		264,5	230,0 to 268,0	0,184	0,1 ≤ t ≤ 0,2	
		264,5	230,0 to 268,0	0,172		
		264,5	230,0 to 268,0	0,182		
		264,6	230,0 to 268,0	0,178		
85% of Un = 195,5		195,4	230,0 to 192,0	1,238	1,2 ≤ t ≤ 1,5	
		195,3	230,0 to 192,0	1,250		
		195,4	230,0 to 192,0	1,246		
		195,3	230,0 to 192,0	1,242		
		195,3	230,0 to 192,0	1,238		
L3		110% of Un	252,6	230,0 to 258,0	2,558	3,0

	= 253,0 (stage 1)*	252,4	230,0 to 258,0	2,558	0,1 ≤ t ≤ 0,2	
		252,3	230,0 to 258,0	2,568		
		252,4	230,0 to 258,0	2,560		
		252,3	230,0 to 258,0	2,556		
	115% of Un = 264,5 (stage 2)	264,4	230,0 to 268,0	0,174		
		264,3	230,0 to 268,0	0,170		
		264,3	230,0 to 268,0	0,176		
		264,3	230,0 to 268,0	0,180		
	85% of Un = 195,5	264,4	230,0 to 268,0	0,168		
		195,4	230,0 to 192,0	1,250		1,2 ≤ t ≤ 1,5
		195,3	230,0 to 192,0	1,238		
		195,3	230,0 to 192,0	1,246		
195,4	230,0 to 192,0	1,246				
		195,4	230,0 to 192,0	1,242		

Note:

*Over-voltage - stage 1: 10-min-value corresponding to EN 50160.

The calculation of the 10 min value shall comply with the 10 min aggregation of EN 61000-4-30, class S. The function shall be based on the calculation of the square root of the arithmetic mean of the squared input values over 10 min. In deviation from EN 61000-4-30, a moving window shall be used. The calculation of a new 10-min value at least every 3 s is sufficient, which is then to be compared with the trip value.

Tolerances on disconnection time are $\pm 10\%$.

The trip values were evaluated by varying the applied voltage from U_n down to $U_{th-low} - 2\%$ of U_n in steps of 0,5% of U_n for under-voltage testing as well as from U_n up to $U_{th-high} + 2\%$ of U_n in steps of 0.5% of U_n for over-voltage testing. Lower and upper threshold voltage shall not fall or rise below or above 2,3V of the trip value itself. The disconnection time was measured by application of a negative voltage step from U_n to the operate value - 5% of U_n as well as positive voltage step from U_n to the operate value + 5% of U_n .

The tests had been performed on the HYD 20KTL-3PH is valid for the HYD 15KTL-3PH, HYD 10KTL-3PH, HYD 8KTL-3PH, HYD 6KTL-3PH and HYD 5KTL-3PH since it is similar in hardware and just power derated by software.

The test results refer to the test report "PV200302N015-6" issued by Bureau Veritas Shenzhen Co., Ltd. Dongguan Branch, dated on 2020.08.21.

Scope pictures of the disconnection time

Over-voltage - Stage 1 (L1 phase)

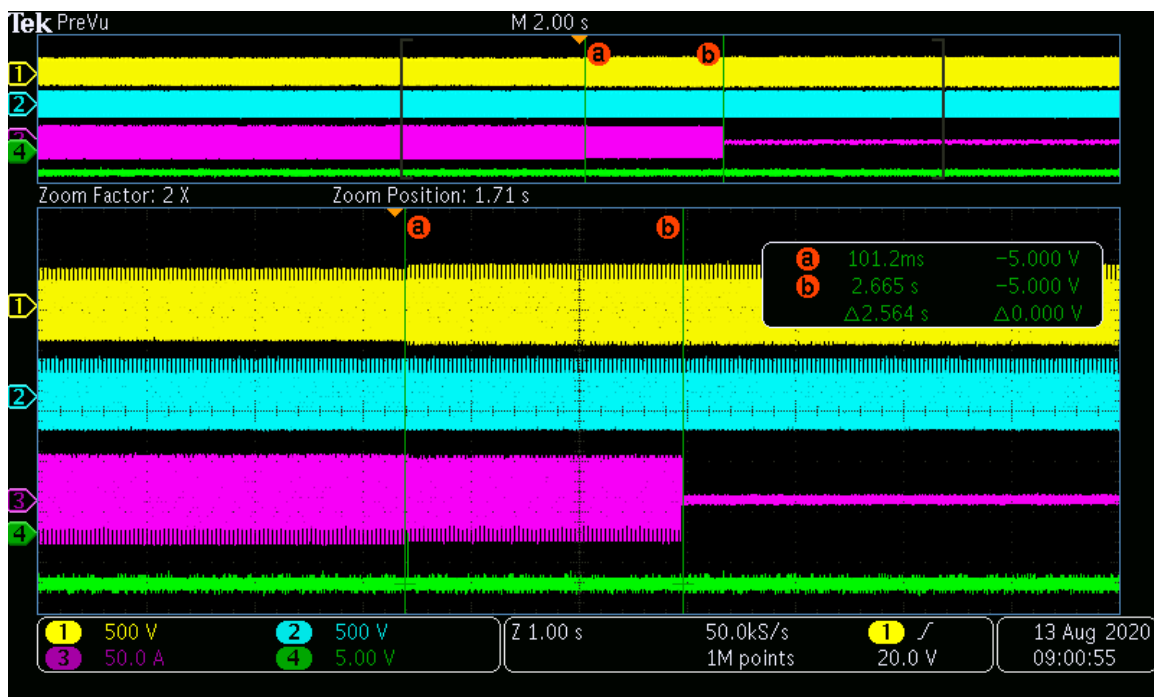

Over-voltage - Stage 2 (L1 phase)



Under-voltage - Stage 1 (L1 phase)

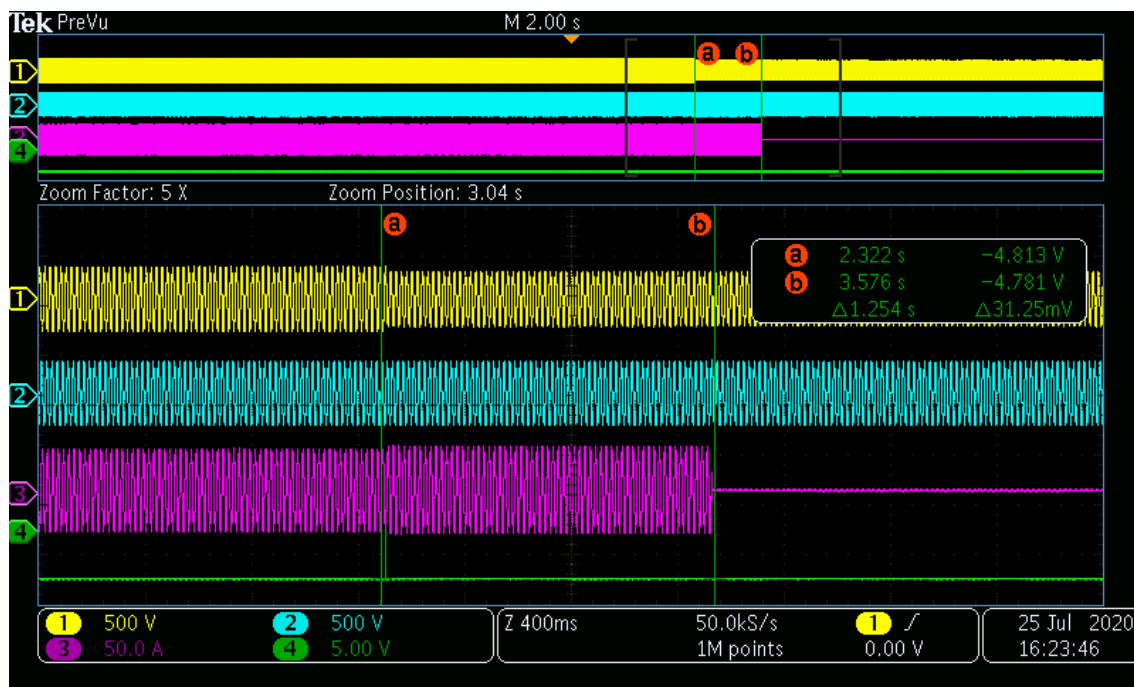

Over-voltage - Stage 1 (L2 phase)

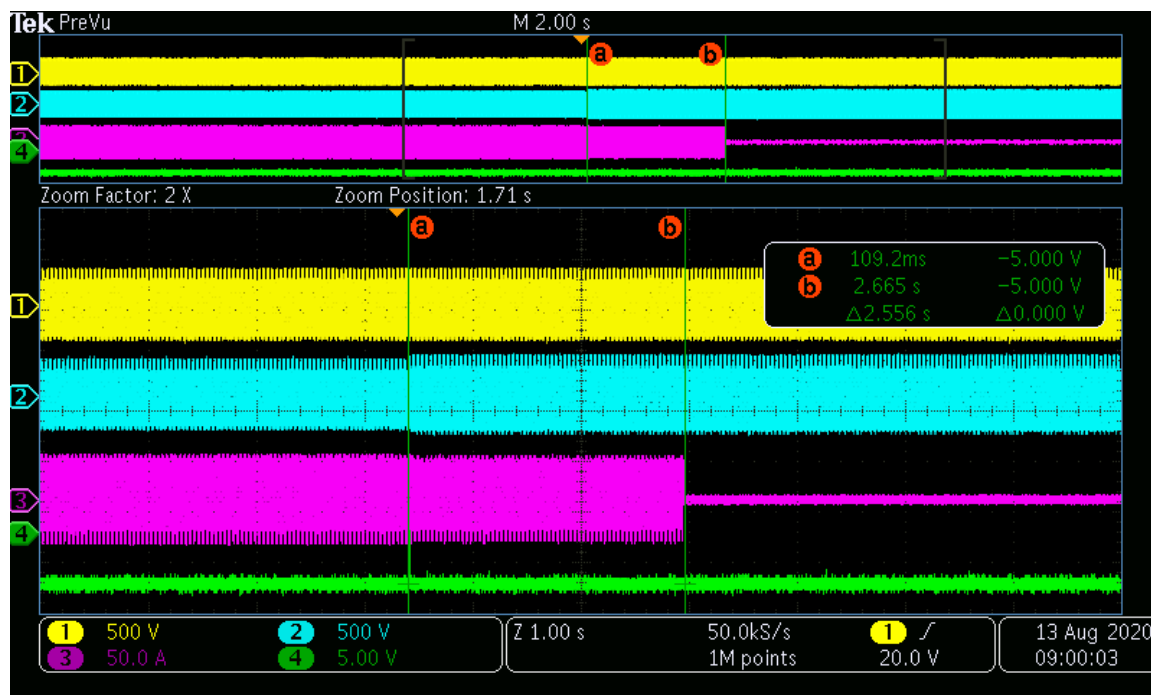

Over-voltage - Stage 2 (L2 phase)

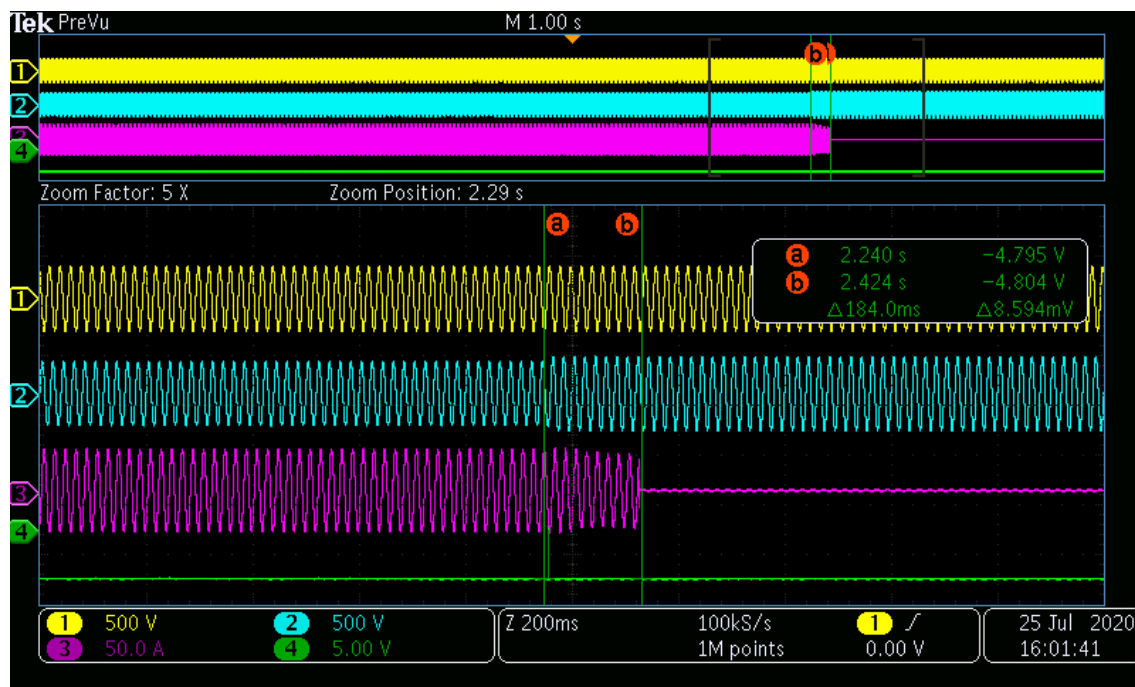

Under-voltage - Stage 1 (L2 phase)

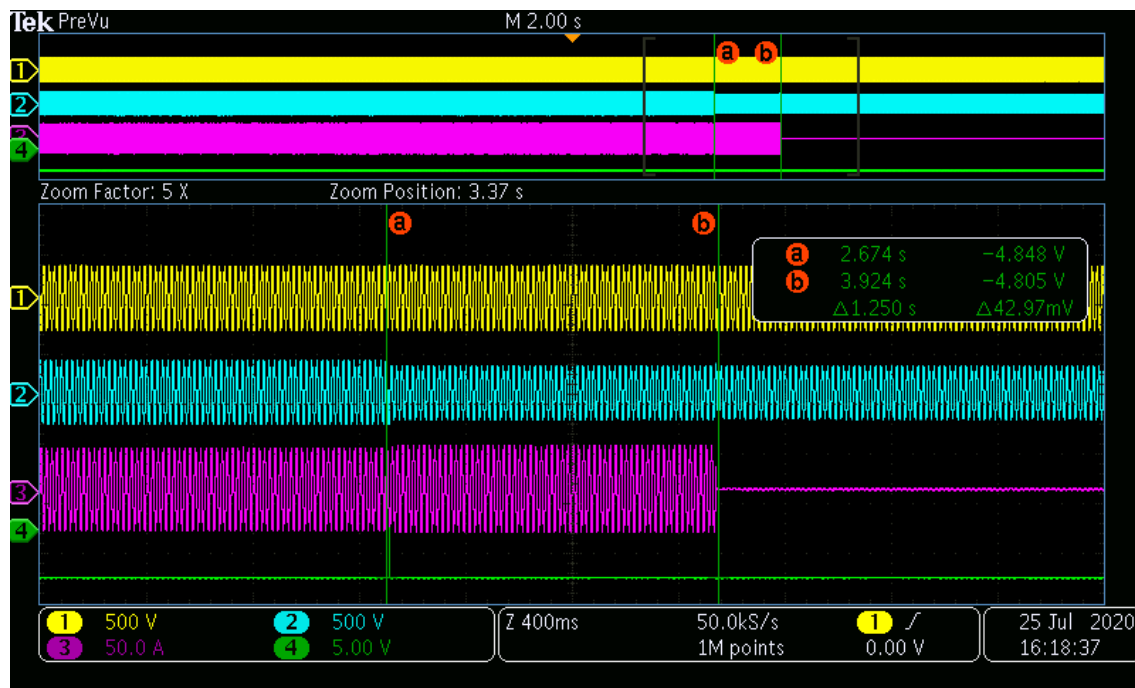

Over-voltage - Stage 1 (L3 phase)

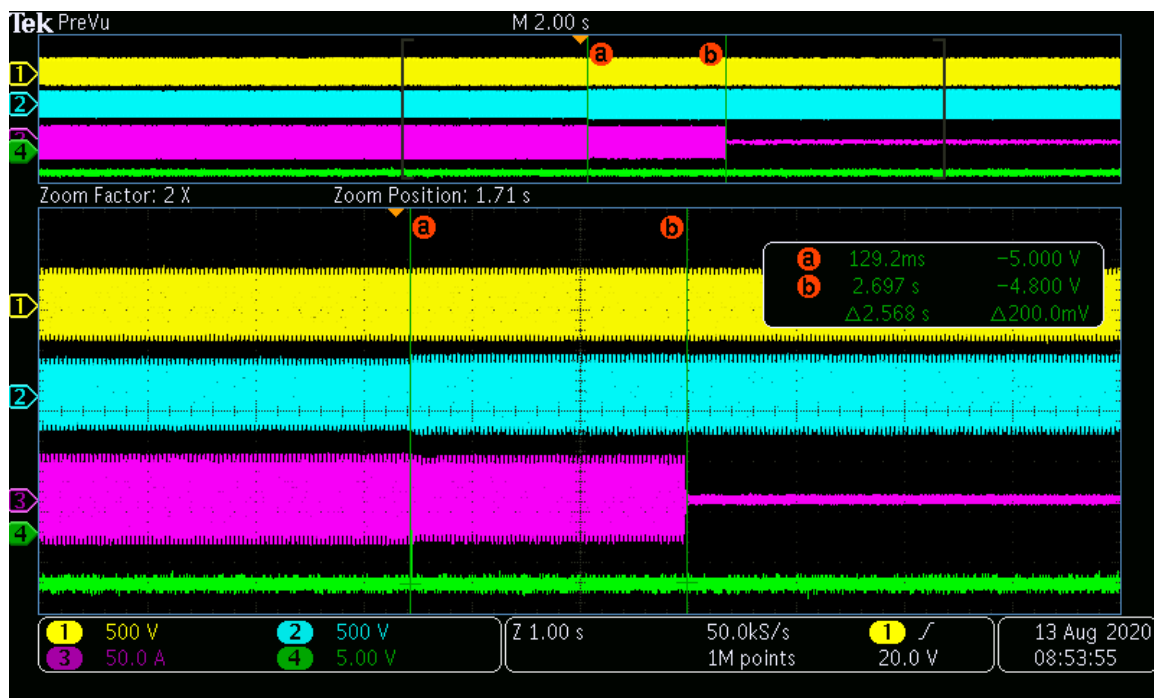

Over-voltage - Stage 2 (L3 phase)

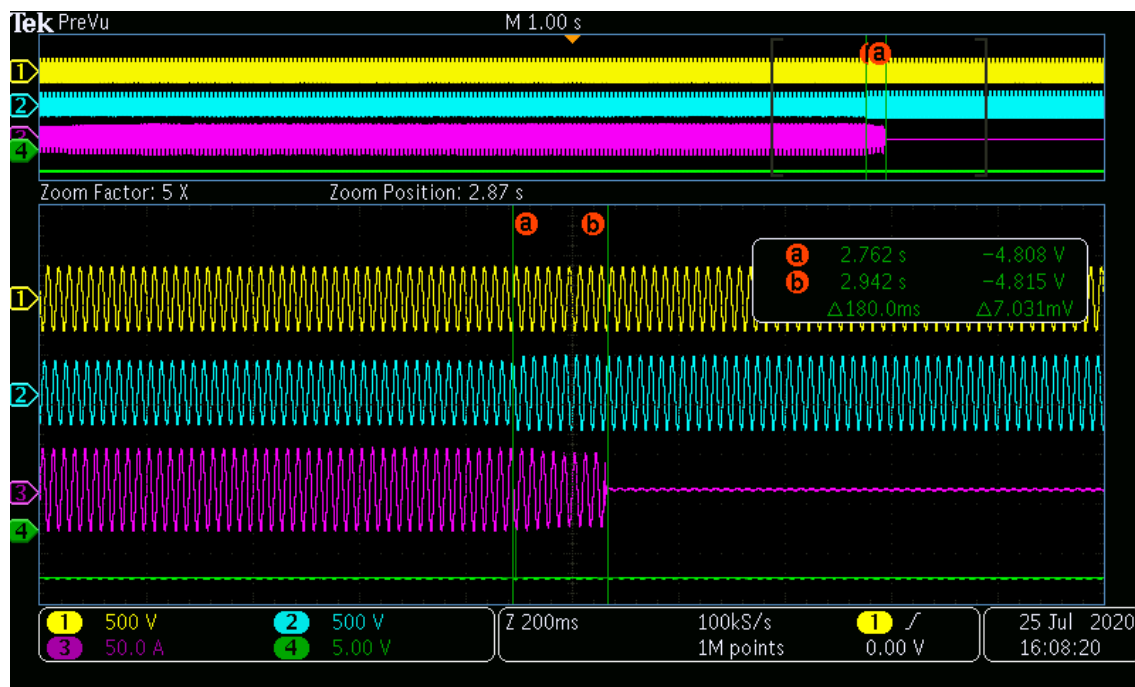

Under-voltage - Stage 1 (L3 phase)

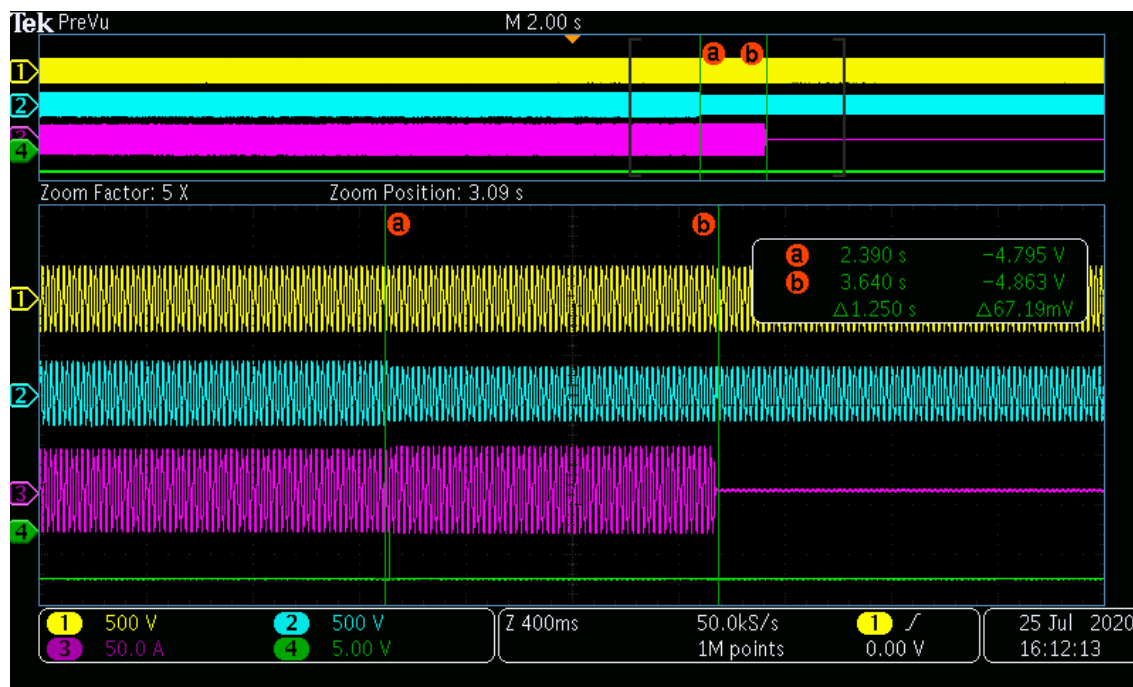

4.9.3 Requirements on voltage and frequency protection					P
4.9.3.1 General (Interface protection: Over/under voltage) (Setting value refer default setting for C10/11)					
Test conditions			Output power: 20,0kW Frequency: 50+/-0,2Hz		
Phase	Limit [V]	Trip value [V]	Voltage step [V]	Disconnection time [s]	Limit [s]
L1	110% of Un = 253,0 (stage 1)	253,4	230,0 to 258,0	0,176	0,2*
		253,5	230,0 to 258,0	0,170	
		253,4	230,0 to 258,0	0,176	
		253,5	230,0 to 258,0	0,169	
		253,4	230,0 to 258,0	0,179	
	115% of Un = 264,5 (stage 2)	264,2	230,0 to 268,0	0,165	0,2*
		264,2	230,0 to 268,0	0,167	
		264,2	230,0 to 268,0	0,177	
		264,2	230,0 to 268,0	0,178	
		264,2	230,0 to 268,0	0,180	
	80% of Un = 184,0	184,2	230,0 to 180,0	0,172	0,2*
		184,4	230,0 to 180,0	0,170	
		184,4	230,0 to 180,0	0,167	
		184,4	230,0 to 180,0	0,168	
		184,3	230,0 to 180,0	0,170	
L2	110% of Un = 253,0 (stage 1)	253,5	230,0 to 258,0	0,161	0,2*
		253,6	230,0 to 258,0	0,171	
		253,5	230,0 to 258,0	0,179	
		253,6	230,0 to 258,0	0,180	
		253,5	230,0 to 258,0	0,173	
	115% of Un = 264,5 (stage 2)	264,8	230,0 to 268,0	0,171	0,2*
		264,8	230,0 to 268,0	0,172	
		264,8	230,0 to 268,0	0,173	
		264,7	230,0 to 268,0	0,174	
		264,7	230,0 to 268,0	0,173	
	80% of Un = 184,0	184,6	230,0 to 180,0	0,169	0,2*
		184,7	230,0 to 180,0	0,179	
		184,6	230,0 to 180,0	0,173	
		184,6	230,0 to 180,0	0,181	
		184,6	230,0 to 180,0	0,182	
L3	110% of Un	253,7	230,0 to 258,0	0,165	0,2*

	= 253,0 (stage 1)	253,7	230,0 to 258,0	0,155	0,2*
		253,8	230,0 to 258,0	0,160	
		253,7	230,0 to 258,0	0,166	
		253,7	230,0 to 258,0	0,157	
	115% of U_n = 264,5 (stage 2)	265,8	230,0 to 268,0	0,156	
		265,8	230,0 to 268,0	0,158	
		265,7	230,0 to 268,0	0,157	
		265,8	230,0 to 268,0	0,159	
		265,8	230,0 to 268,0	0,157	
	80% of U_n = 184,0	184,4	230,0 to 180,0	0,184	
		184,3	230,0 to 180,0	0,186	
		184,4	230,0 to 180,0	0,178	
		184,4	230,0 to 180,0	0,187	
		184,4	230,0 to 180,0	0,180	

Note:

The trip values were evaluated by varying the applied voltage from U_n down to $U_{th-low} - 2\%$ of U_n in steps of 0,5% of U_n for under-voltage testing as well as from U_n up to $U_{th-high} + 2\%$ of U_n in steps of 0,5% of U_n for over-voltage testing, Lower and upper threshold voltage shall not fall or rise below or above 2,3V of the trip value itself, The disconnection time was measured by application of a negative voltage step from U_n to the operate value -5% of U_n as well as positive voltage step from U_n to the operate value +5% of U_n .

The tests had been performed on the HYD 20KTL-3PH is valid for the HYD 15KTL-3PH, HYD 10KTL-3PH, HYD 8KTL-3PH, HYD 6KTL-3PH and HYD 5KTL-3PH since it is similar in hardware and just power derated by software.

Scope pictures of the disconnection time

Over-voltage - Stage 1 (L1 phase)

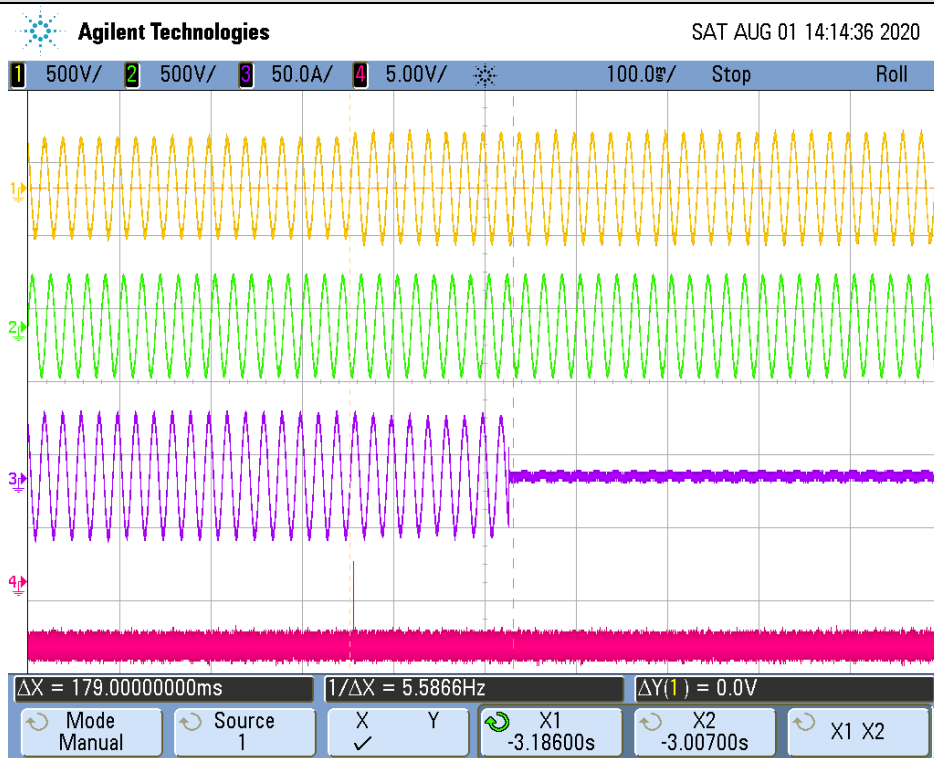

Over-voltage - Stage 2 (L1 phase)

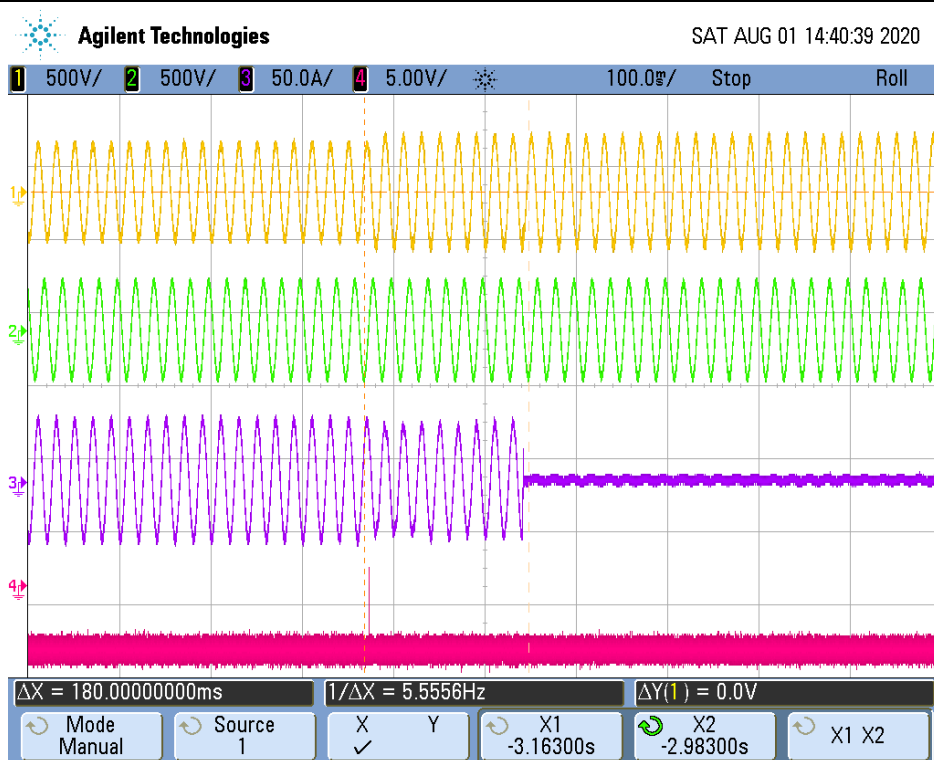

Under-voltage - Stage 1 (L1 phase)

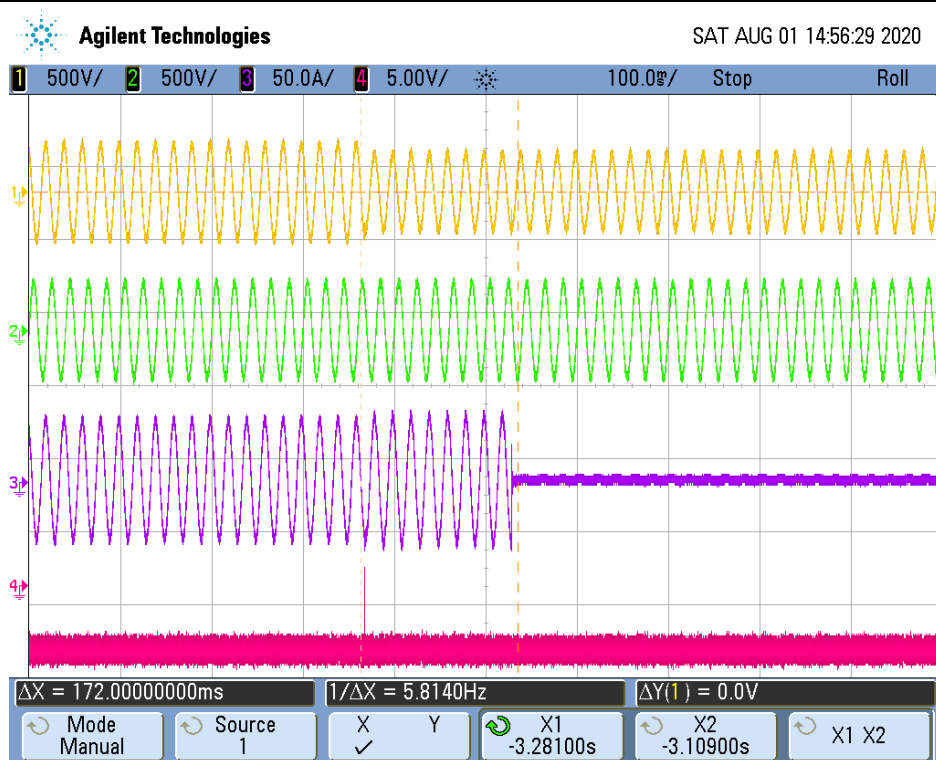

Over-voltage - Stage 1 (L2 phase)

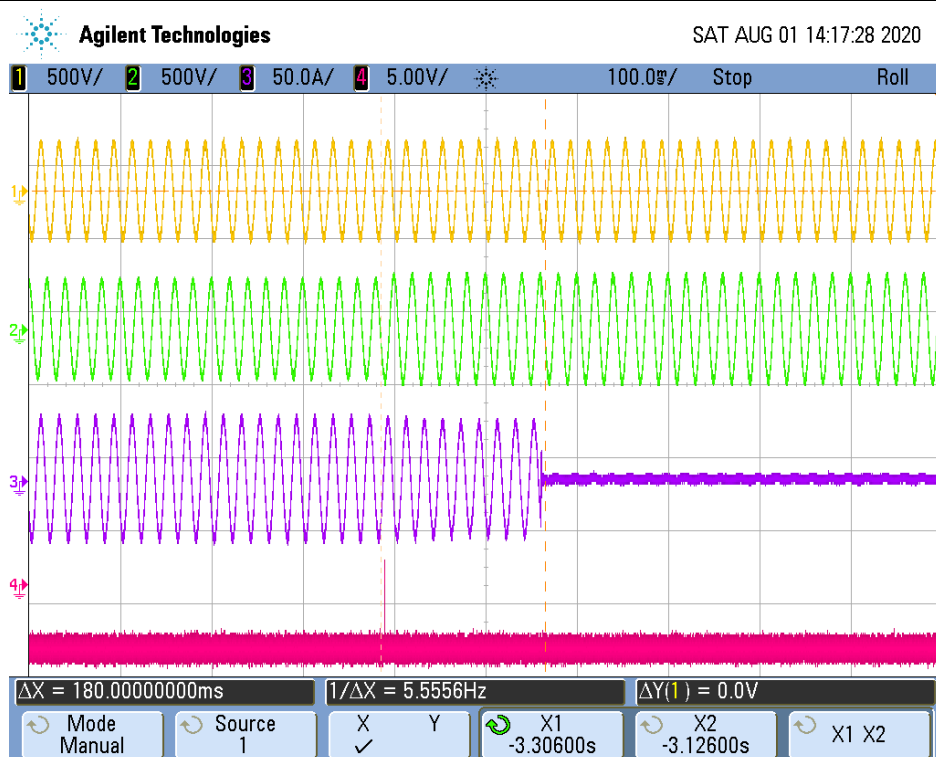

Over-voltage - Stage 2 (L2 phase)

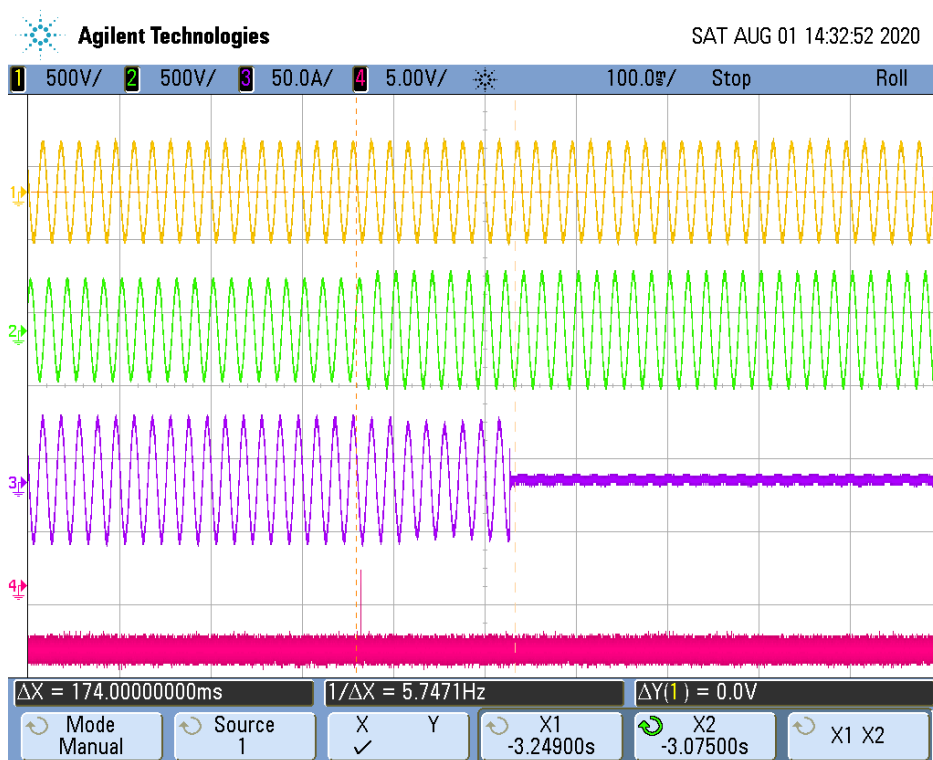

Under-voltage - Stage 1 (L2 phase)

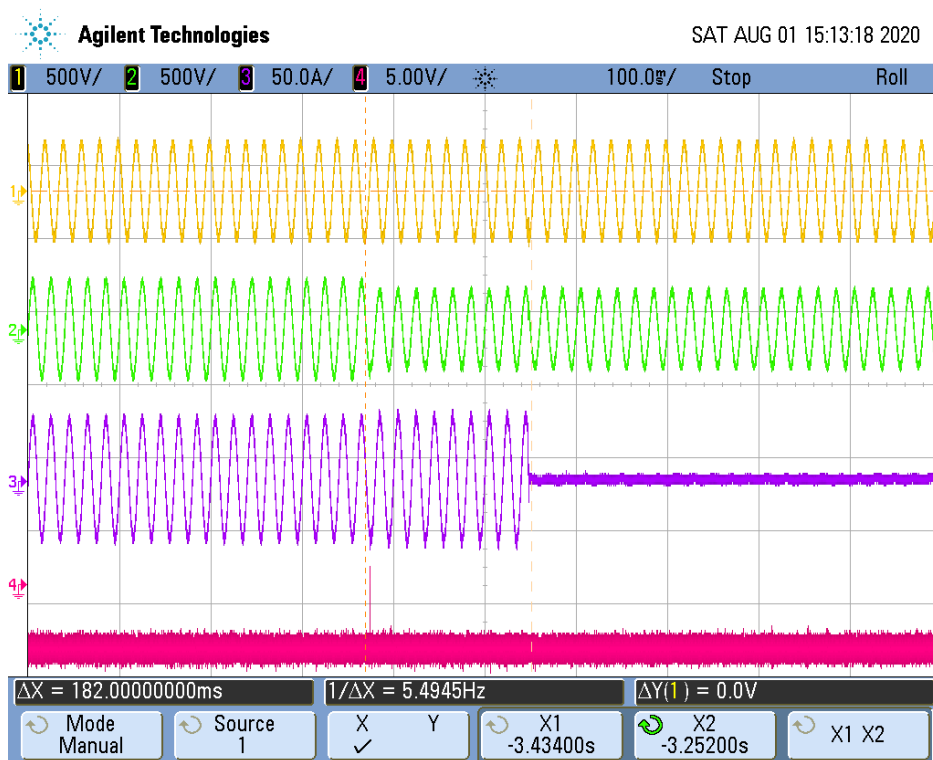

Over-voltage - Stage 1 (L3 phase)

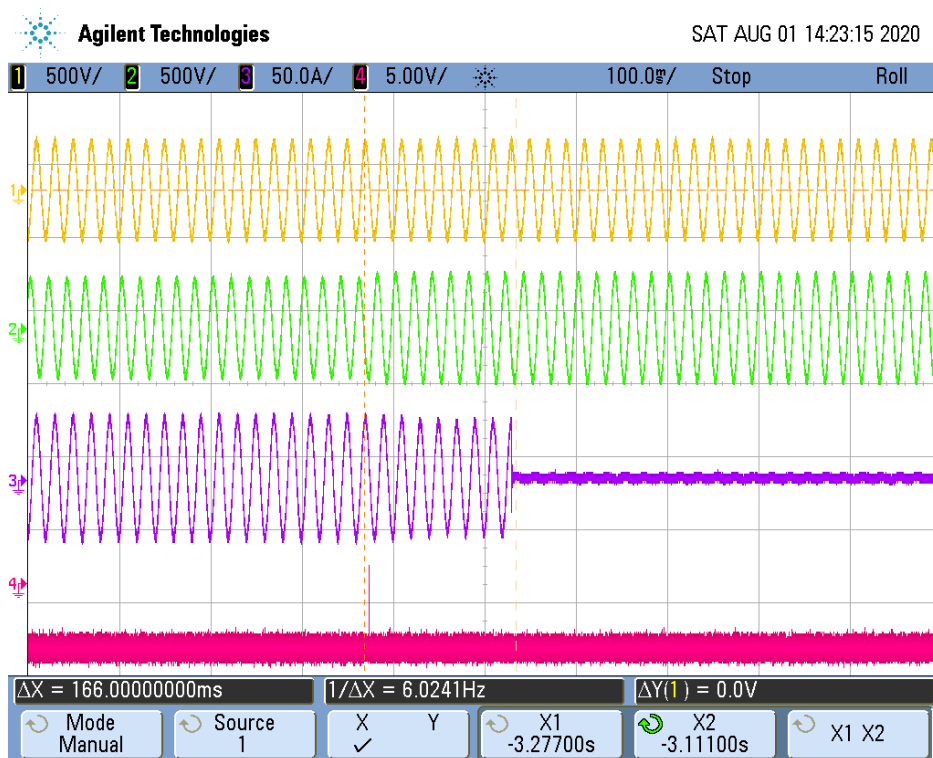

Over-voltage - Stage 2 (L3 phase)

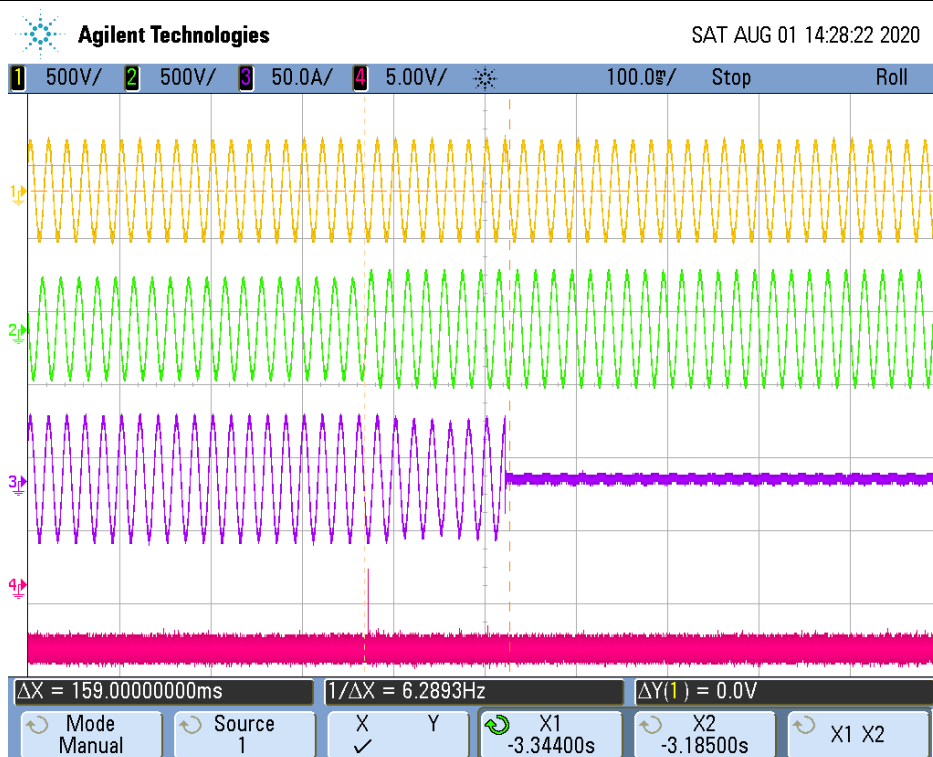

Under-voltage - Stage 1 (L3 phase)

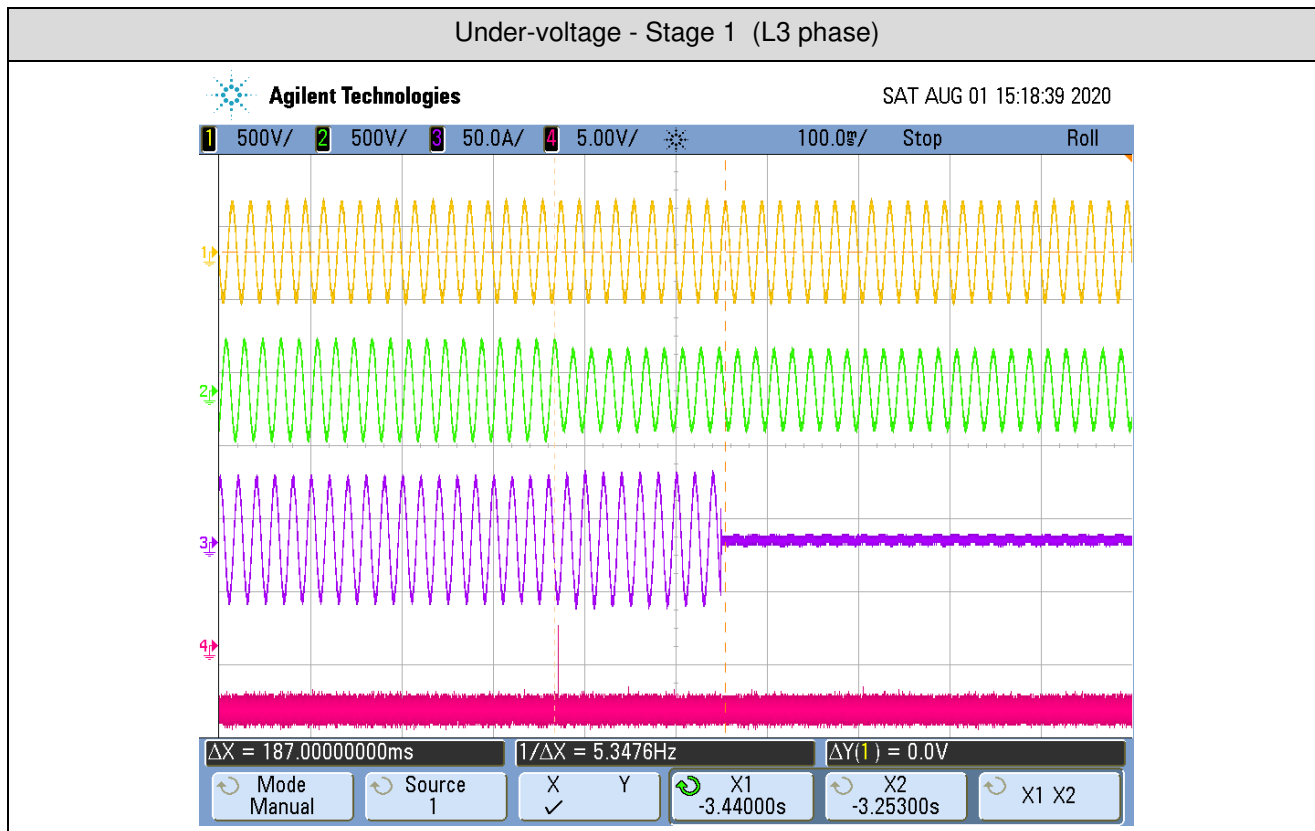

4.9.3 Requirements on voltage and frequency protection		P
4.9.3.1 General (Maximum voltage 10 min mean protection according to EN 50160) (Setting value refer EN 50438 for default settings)		
Setting values of the protection:	Trip value Setting [V]	253
	Setting $T_{\text{disconnection trip value}}$ [s]	600
	Setting $T_{\text{disconnection}}$ [ms]	200
Test:		
	Disconnection time [s]	Limit [s]
a)	The voltage is set to 100% U_n and held for 600 s, Thereafter the voltage is set to 112% U_n , Disconnection must take place within 600 s,	
	Phase 1:	496 s
	Phase 2:	489 s
	Phase 3:	469 s
		≤ 600 s
b)	The voltage is set to U_n for 600 s and then to 108% U_n for 600 s, No disconnection should take place,	
	Phase 1:	No Disconnection
	Phase 2:	No Disconnection
	Phase 3:	No Disconnection
		Disconnection should not take place,
c)	The voltage is set to 106 % U_n and held for 600 s, Thereafter the voltage is set to 114 % U_n , The disconnection should last for half the period as in Point a)*	
	Phase 1:	302 s
	Phase 2:	287 s
	Phase 3:	268 s
		The disconnection time should be about 50 % of the value measured in a), *
Test:		
a) This test serves as proof of the measurement accuracy and the maximum set time.		
b) This test serves as proof of the measurement accuracy.		
c) This test serves as proof of the correct formation of the 1 minute running mean value.		
Assessment criterion:		
The permitted tolerance between setting value and trip value of the voltage may not exceed $\pm 1\%$ of U_n .		
<u>Limit values:</u>		
Rise-in voltage protection 1,1 U_n after a max. 600 s, the switch off after 200 ms.		
Note:		
If only one integrated protection is used for the power generation systems, the value of the rise-in voltage protection of 1,1 U_n may not be changed.		
*If the setting value is set to 600 s, then the disconnection time can be in the range between 225 s and 375 s.		
The tests had been performed on the HYD 20KTL-3PH is valid for the HYD 15KTL-3PH, HYD 10KTL-3PH, HYD 8KTL-3PH, HYD 6KTL-3PH and HYD 5KTL-3PH since it is similar in hardware and just power derated by software.		
The test results refer to the test report "PV200302N015-6" issued by Bureau Veritas Shenzhen Co., Ltd. Dongguan Branch, dated on 2020.08.21.		

Graph of test a) Voltage set to 112 % U_n :

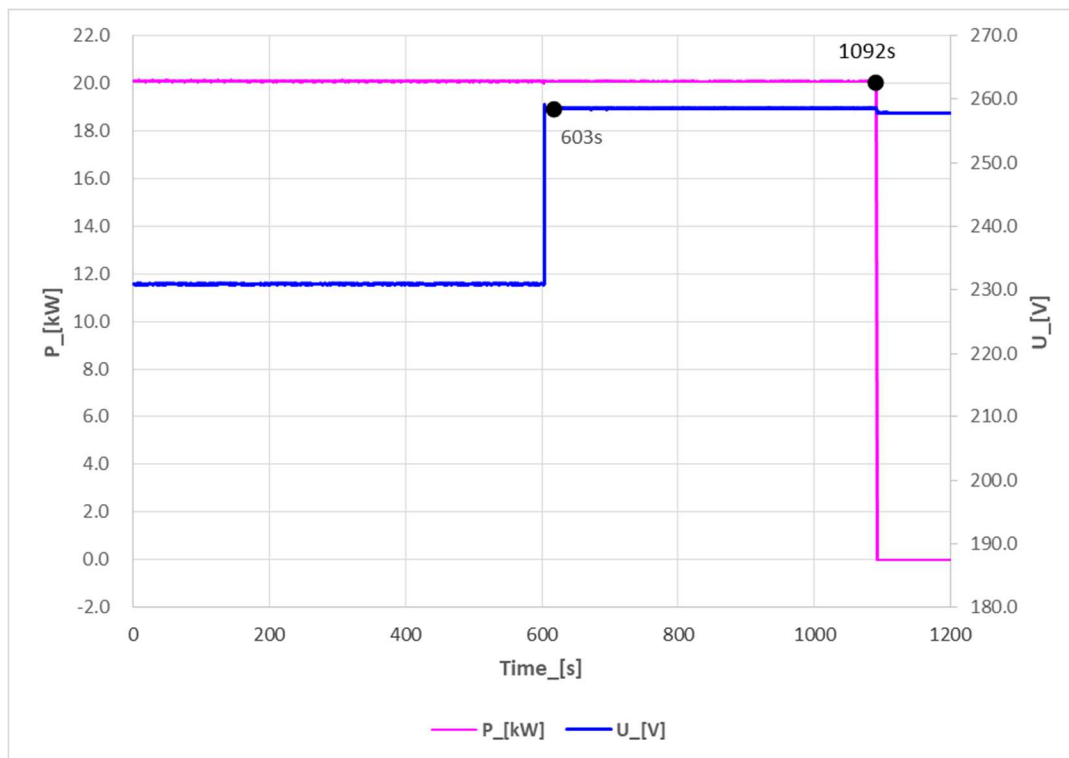

Graph of test b) Voltage set to 108 % U_n :

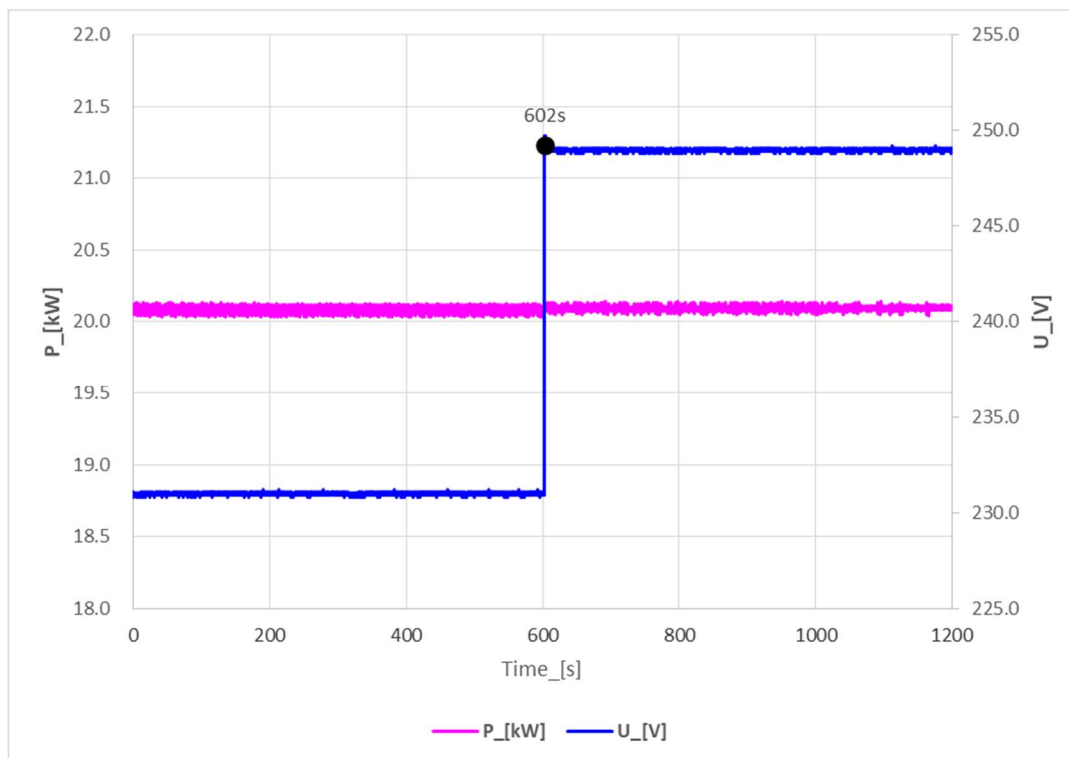

Graph of test c) Voltage set to 106 % U_n , thereafter 114% U_n :

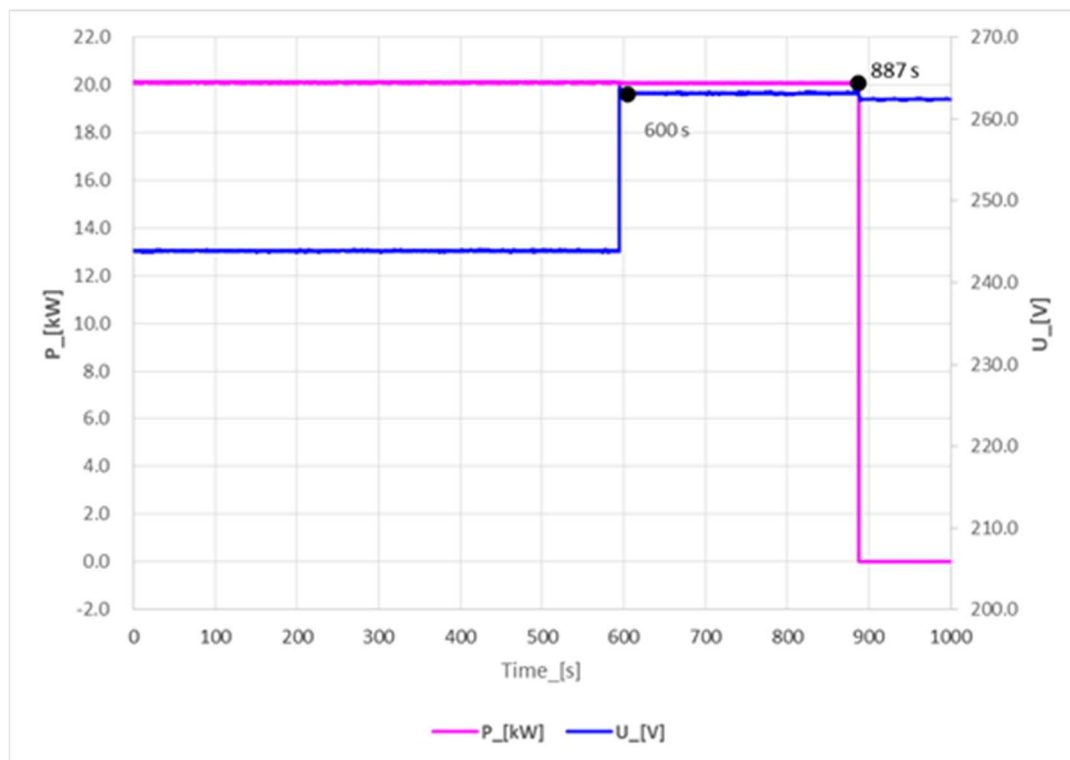

4.9.3 Requirements on voltage and frequency protection				P
4.9.3.1 General (Interface protection: Over/under frequency) (Setting value refer EN 50438 Default setting)				
Test conditions	Output power: 20,0kW $U_n = 230V_{ac}$			
	Under-frequency		Over-frequency	
Parameter	Under-Frequency	Time	Over-Frequency	Time
Limit	47,50 Hz	$0,3 \leq t \leq 0,5 \text{ s}$	52,00 Hz	$0,3 \leq t \leq 0,5 \text{ s}$
Trip value [Hz]	47,49		52,00	
	47,49		52,00	
	47,49		52,00	
	47,49		52,00	
	47,49		52,00	
Disconnection time [s]	50,00 Hz to 47,40 Hz	0,449	50,00 Hz to 52,10 Hz	0,431
		0,449		0,437
		0,443		0,435
		0,451		0,453
		0,429		0,435

Note:

For under-frequency testing the applied frequency is varied from f_n down to $f_{th-low} - 0,1 \text{ Hz}$ in steps of $0,025 \text{ Hz}$ with a time duration per step exceeding the configured disconnection time, The operate value is the value of the applied frequency at switch the protection function trips and shall be within $f_{th-low} \pm 0,05 \text{ Hz}$.

For over-frequency testing the applied frequency is varied from f_n up to $f_{th-high} + 0,1 \text{ Hz}$ in steps of $0,025 \text{ Hz}$ with a time duration per step exceeding the configured disconnection time, The operate value is the value of the applied frequency at which the protection function trips and shall be within $f_{th-high} \pm 0,05 \text{ Hz}$.

The oscilloscope pictures below show the measured worst case disconnection times.

The tests had been performed on the HYD 20KTL-3PH is valid for the HYD 15KTL-3PH, HYD 10KTL-3PH, HYD 8KTL-3PH, HYD 6KTL-3PH and HYD 5KTL-3PH since it is similar in hardware and just power derated by software.

The test results refer to the test report "PV200302N015-6" issued by Bureau Veritas Shenzhen Co., Ltd.

Dongguan Branch, dated on 2020.08.21.

Scope pictures of the disconnection time

Under-frequency

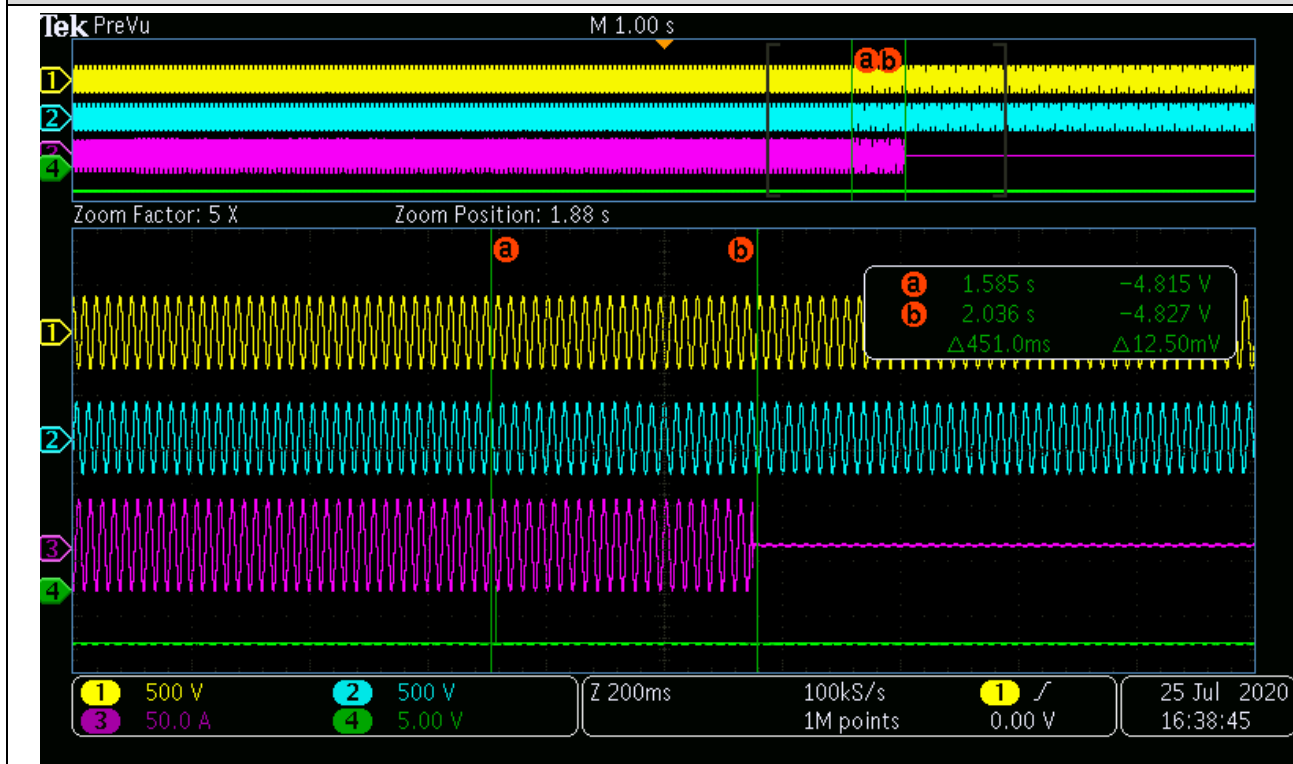

Over-frequency

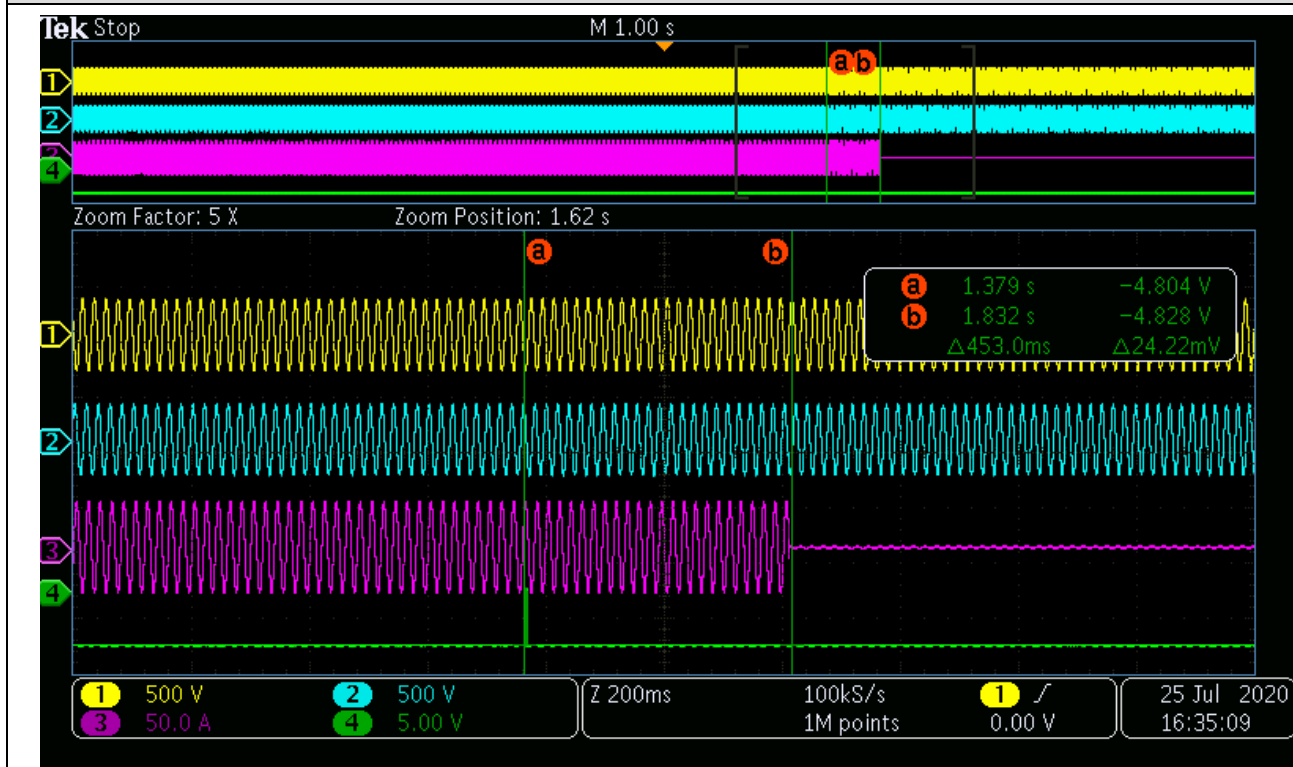

4.9.3 Requirements on voltage and frequency protection				P
4.9.3.1 General (Interface protection: Over/under frequency) (Setting value refer default setting for C10/11)				
Test conditions	Output power: 20,0kW $U_n = 230V_{ac}$			
	Under-frequency		Over-frequency	
Parameter	Under-Frequency	Time	Over-Frequency	Time
Limit	47,50 Hz	0,2s	51,50 Hz	0,2s
Trip value [Hz]	47,49		51,50	
	47,49		51,50	
	47,49		51,50	
	47,49		51,50	
	47,49		51,50	
Disconnection time [s]	50,00 Hz to 47,40 Hz	0,172	50,00 Hz to 52,10 Hz	0,165
		0,182		0,177
		0,183		0,178
		0,165		0,165
		0,162		0,182

Note:

For under-frequency testing the applied frequency is varied from f_n down to $f_{th-low} - 0,1$ Hz in steps of 0,025 Hz with a time duration per step exceeding the configured disconnection time, The operate value is the value of the applied frequency at switch the protection function trips and shall be within $f_{th-low} \pm 0,05$ Hz.

For over-frequency testing the applied frequency is varied from f_n up to $f_{th-high} + 0,1$ Hz in steps of 0,025 Hz with a time duration per step exceeding the configured disconnection time, The operate value is the value of the applied frequency at which the protection function trips and shall be within $f_{th-high} \pm 0,05$ Hz.

The oscilloscope pictures below show the measured worst case disconnection times.

The tests had been performed on the HYD 20KTL-3PH is valid for the HYD 15KTL-3PH, HYD 10KTL-3PH, HYD 8KTL-3PH, HYD 6KTL-3PH and HYD 5KTL-3PH since it is similar in hardware and just power derated by software.

Scope pictures of the disconnection time

Under-frequency

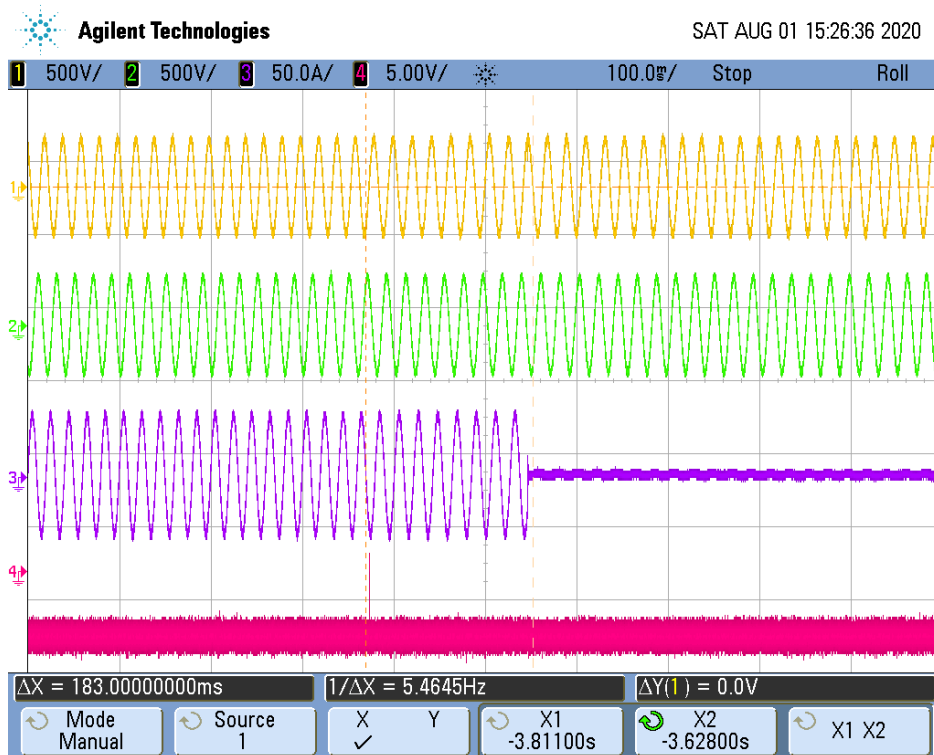

Over-frequency

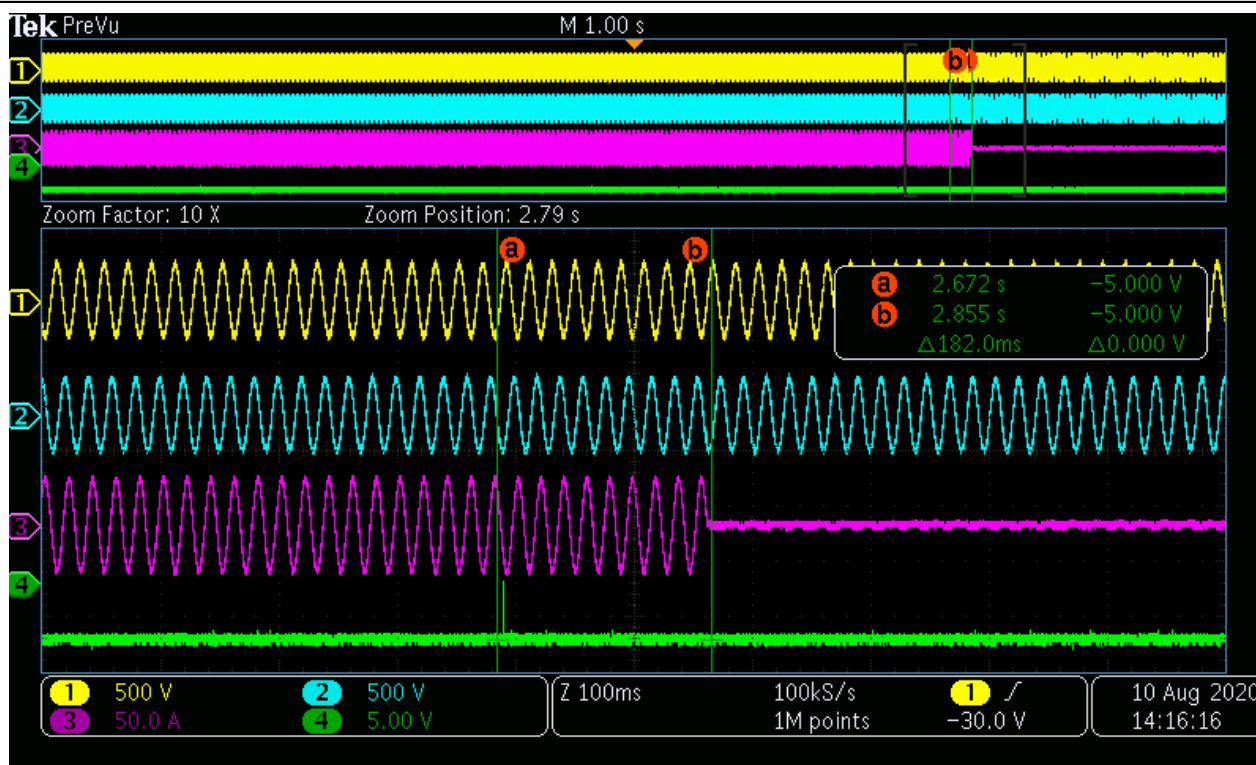

4.9.4.2 Loss of Mains (LoM) detection

Test circuit and parameters

Parameter	Symbol	Units
EUT DC Input		
DC voltage	V_{DC}	V
DC Current	I_{DC}	A
DC Power	P_{DC}	W
EUT AC output		
AC voltage	V_{EUT}	V
AC current	I_{EUT}	A
Real power	P_{EUT}	W
Reactive power	Q_{EUT}	VA _r
Test Load		
Resistive load current	I_R	A
Inductive load current	I_L	A
Capacitive load current	I_C	A
AC (utility) power source		
Utility real power	P_{AC}	W
Utility reactive power	Q_{AC}	VA _r
Utility current	I_{AC}	A

Block diagram test circuit IEC 62116:2014

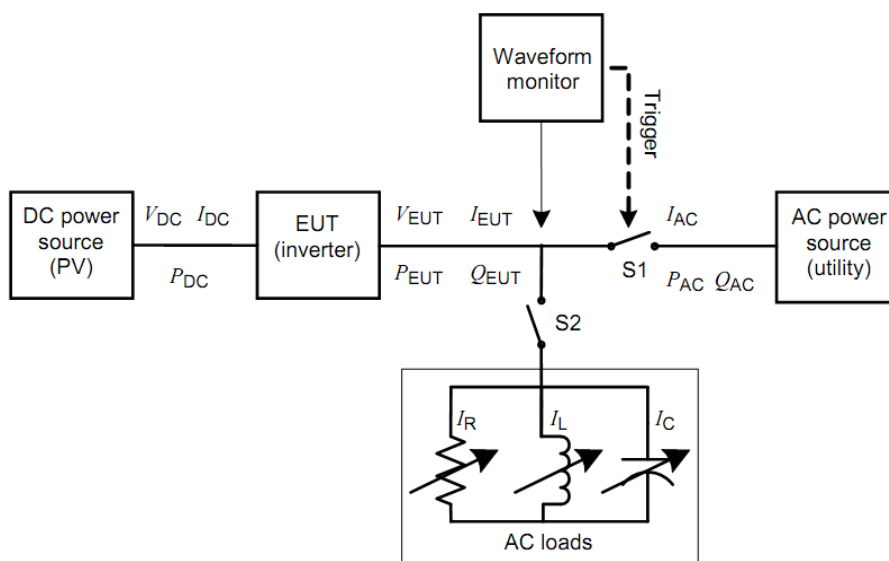

IEC 1567/08

Figure 1 – Test circuit for islanding detection function in a power conditioner (inverter)

Load imbalance (real, reactive load) for test condition A (EUT output = 100%)										P
Test :										
Test conditions			Frequency: 50+/-0,1Hz U _N =230+/-3Vac Distortion factor of chokes < 2% Quality = 1							
Disconnection limit			2s (IEC 62116)							
No	P _{EUT} ¹⁾ [% of EUT rating]	Reactive load [% of Q _L in 6,1,d) ¹⁾	P _{AC} ²⁾ [% of nominal]	Q _{AC} ³⁾ [% of nominal]	I _{AC} ⁴⁾ [A]	P _{EUT} [kW per phase]	V _{DC} [V]	Q _f	Run on Time [ms]	Remarks ⁵⁾
1	100	100	0	0	0,156	6,630	738	1,000	544	BL
2	100	100	-5	-5	1,559	6,630	738	1,026	404	IB
3	100	100	-5	0	1,597	6,630	738	1,053	436	IB
4	100	100	-5	+5	1,559	6,630	738	1,079	410	IB
5	100	100	0	-5	0,192	6,630	738	0,975	482	IB
6	100	100	0	+5	0,192	6,630	738	1,025	510	IB
7	100	100	+5	-5	1,632	6,630	738	0,929	412	IB
8	100	100	+5	0	1,597	6,630	738	0,953	442	IB
9	100	100	+5	+5	1,632	6,630	738	0,976	414	IB
Parameter at 0% per phase			L= 25,40 mH		R= 7,98 Ω		C= 398,94 μF			
Note:										
RLC is adjusted to min. +/-1% of the inverter rated output power										
1) P _{EUT} : EUT output power.										
2) P _{AC} : Real power flow at S1 in Figure 1. Positive means power from EUT to utility, Nominal is the 0 % test condition value.										
3) Q _{AC} : Reactive power flow at S1 in Figure 1. Positive means power from EUT to utility, Nominal is the 0 % test condition value.										
4) Fundamental of I _{AC} when RLC is adjusted.										
5) BL: Balance condition, IB: Imbalance condition.										
Condition A:										
EUT output power P _{EUT} = Maximum ⁶⁾										
EUT input voltage ⁶⁾ = >75% of rated input voltage range										
6) Maximum EUT output power condition should be achieved using the maximum allowable input power, Actual output power may exceed nominal rated output.										
7) Based on EUT rated input operating range, For example, If range is between X volts and Y volts, 75 % of range = X + 0,75 × (Y – X), Y shall not exceed 0,8 × EUT maximum system voltage (i.e., maximum allowable array open circuit voltage), In any case, the EUT should not be operated outside of its allowable input voltage range.										

The tests had been performed on the HYD 20KTL-3PH is valid for the HYD 15KTL-3PH, HYD 10KTL-3PH, HYD 8KTL-3PH, HYD 6KTL-3PH and HYD 5KTL-3PH since it is similar in hardware and just power derated by software.

The test results refer to the test report "PV200302N015-6" issued by Bureau Veritas Shenzhen Co., Ltd. Dongguan Branch, dated on 2020.08.21.

Scope pictures of the disconnection time

Disconnection at No. 1

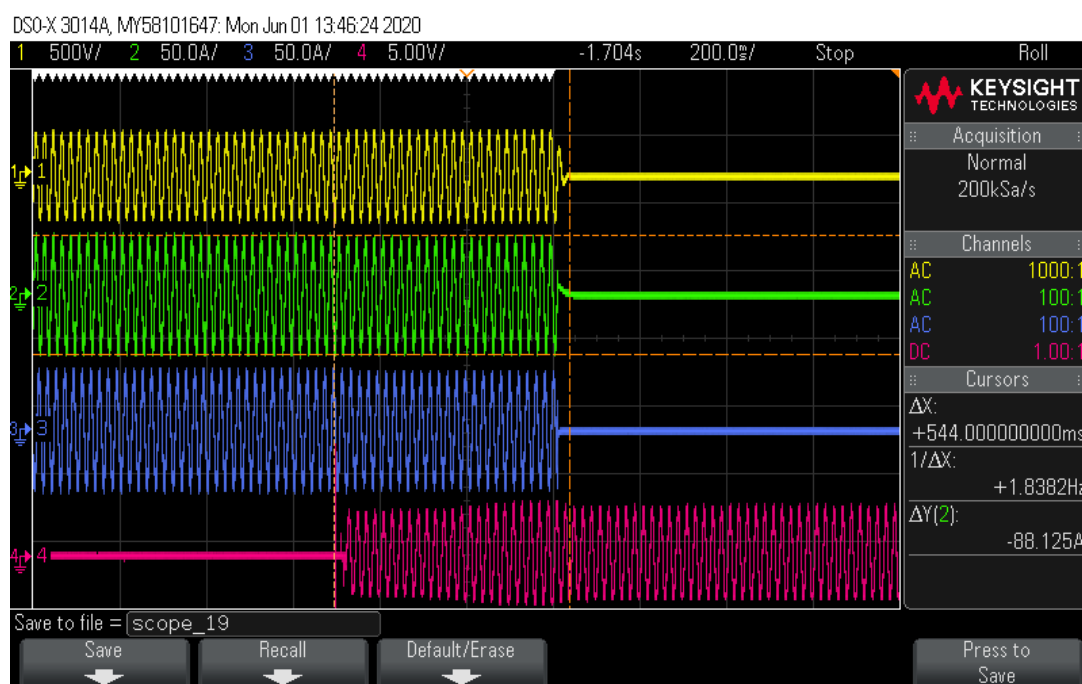

Load imbalance (reactive load) for test condition B (EUT output = 50 % – 66 %)										P
Test :										
Test conditions			Frequency: 50+/-0,1Hz U _N =230+/-3Vac Distortion factor of chokes < 2% Quality =1							
Disconnection limit			2s (IEC 62116)							
No	P _{EUT} ¹⁾ [% of EUT rating]	Reactive load [% of Q _L in 6,1,d) ¹⁾	P _{AC} ²⁾ [% of nominal]	Q _{AC} ³⁾ [% of nominal]	I _{AC} ⁴⁾ [A]	P _{EUT} [kW per phase]	V _{DC} [V]	Q _f	Run on Time [ms]	Remarks ⁵⁾
1	66	66	0	-5	0,147	4,385	490	0,974	418	IB
2	66	66	0	-4	0,138	4,385	490	0,979	430	IB
3	66	66	0	-3	0,131	4,385	490	0,984	444	IB
4	66	66	0	-2	0,126	4,385	490	0,989	446	IB
5	66	66	0	-1	0,123	4,385	490	0,994	462	IB
6	66	66	0	0	0,122	4,385	490	0,999	496	BL
7	66	66	0	+1	0,123	4,385	490	1,004	490	IB
8	66	66	0	+2	0,125	4,385	490	1,009	468	IB
9	66	66	0	+3	0,130	4,385	490	1,014	458	IB
10	66	66	0	+4	0,136	4,385	490	1,019	452	IB
11	66	66	0	+5	0,145	4,385	490	1,024	404	IB
Parameter at 0% per phase			L= 77,13 mH		R= 24,38 Ω			C= 131,36μF		
Note:										
RLC is adjusted to min. +/-1% of the inverter rated output power										
1) P _{EUT} : EUT output power.										
2) P _{AC} : Real power flow at S1 in Figure 1, Positive means power from EUT to utility, Nominal is the 0 % test condition value.										
3) Q _{AC} : Reactive power flow at S1 in Figure 1, Positive means power from EUT to utility, Nominal is the 0 % test condition value.										
4) Fundamental of I _{AC} when RLC is adjusted.										
5) BL: Balance condition, IB: Imbalance condition.										
Condition B:										
EUT output power P _{EUT} = 50 % – 66 % of maximum										
EUT input voltage ⁶⁾ = 50 % of rated input voltage range, ±10 %										
6) Based on EUT rated input operating range, For example, If range is between X volts and Y volts, 50 % of range = X + 0,5 × (Y – X), Y shall not exceed 0,8 × EUT maximum system voltage (i.e., maximum allowable array open circuit voltage), In any case, the EUT should not be operated outside of its allowable input voltage range.										

The tests had been performed on the HYD 20KTL-3PH is valid for the HYD 15KTL-3PH, HYD 10KTL-3PH, HYD 8KTL-3PH, HYD 6KTL-3PH and HYD 5KTL-3PH since it is similar in hardware and just power derated by software.

The test results refer to the test report "PV200302N015-6" issued by Bureau Veritas Shenzhen Co., Ltd. Dongguan Branch, dated on 2020.08.21.

Scope pictures of the disconnection time

Disconnection at No. 6

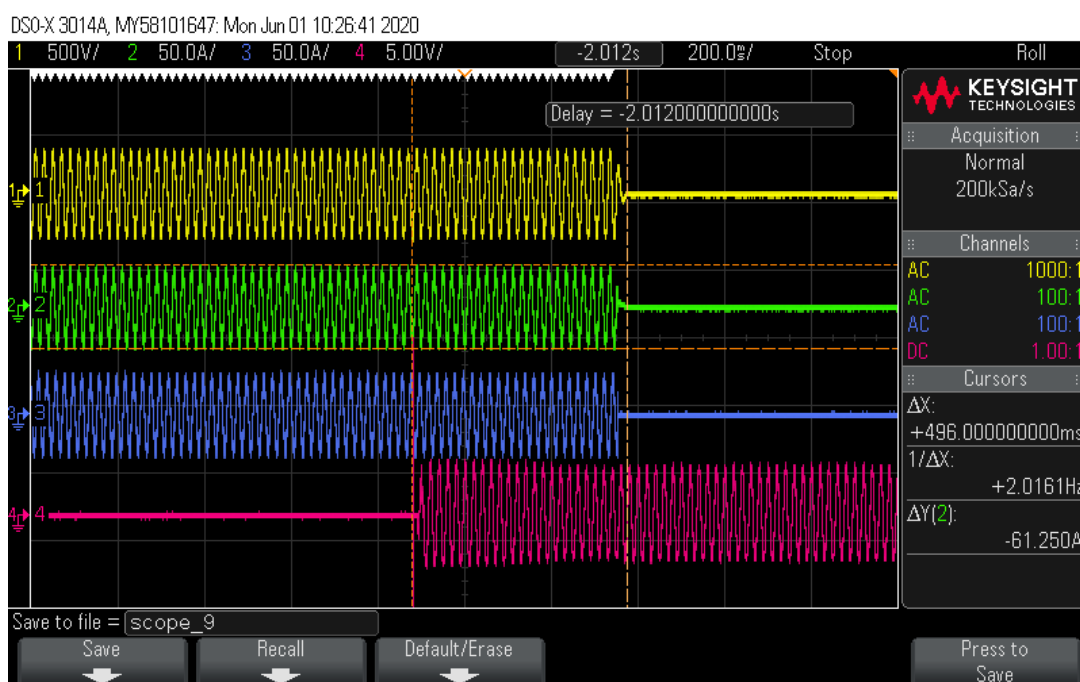

Load imbalance (reactive load) for test condition C (EUT output = 25 % – 33 %)	P
---	----------

Test :

Test conditions	Frequency: 50+/-0,1Hz U _N =230+/-3Vac Distortion factor of chokes < 2% Quality =1
Disconnection limit	2s (IEC 62116)

No	P _{EUT} ¹⁾ [% of EUT rating]	Reactive load [% of Q _L in 6,1,d) ¹⁾	P _{AC} ²⁾ [% of nominal]	Q _{AC} ³⁾ [% of nominal]	I _{AC} ⁴⁾ [A]	P _{EUT} [kW per phase]	V _{DC} [V]	Q _f	Run on Time [ms]	Remarks ⁵⁾
1	33	33	0	-5	0,195	2,205	242	0,974	380	IB
2	33	33	0	-4	0,191	2,205	242	0,979	442	IB
3	33	33	0	-3	0,187	2,205	242	0,984	448	IB
4	33	33	0	-2	0,185	2,205	242	0,989	466	IB
5	33	33	0	-1	0,183	2,205	242	0,994	482	IB
6	33	33	0	0	0,183	2,205	242	0,999	518	BL
7	33	33	0	+1	0,183	2,205	242	1,004	508	IB
8	33	33	0	+2	0,185	2,205	242	1,009	444	IB
9	33	33	0	+3	0,187	2,205	242	1,014	424	IB
10	33	33	0	+4	0,191	2,205	242	1,019	422	IB
11	33	33	0	+5	0,195	2,205	242	1,024	396	IB

Parameter at 0% per phase	L= 151,56 mH	R= 48,09 Ω	C= 66,85 μF
---------------------------	--------------	------------	-------------

Note:

RLC is adjusted to min. +/-1% of the inverter rated output power

1) P_{EUT}: EUT output power.

2) P_{AC}: Real power flow at S1 in Figure 1, Positive means power from EUT to utility, Nominal is the 0 % test condition value.

3) Q_{AC}: Reactive power flow at S1 in Figure 1, Positive means power from EUT to utility, Nominal is the 0 % test condition value.

4) Fundamental of I_{AC} when RLC is adjusted.

5) BL: Balance condition, IB: Imbalance condition.

Condition B:

EUT output power P_{EUT} = 25 % – 33 %⁶⁾ of maximum

EUT input voltage⁷⁾ = <20 % of rated input voltage range

⁶⁾ Or minimum allowable EUT output level if greater than 33 %.

⁷⁾ Based on EUT rated input operating range, For example, If range is between X volts and Y volts, 20 % of range = X + 0,2 × (Y – X), Y shall not exceed 0,8 × EUT maximum system voltage (i.e., maximum allowable array open circuit voltage), In any case, the EUT should not be operated outside of its allowable input voltage

range.

The tests had been performed on the HYD 20KTL-3PH is valid for the HYD 15KTL-3PH, HYD 10KTL-3PH, HYD 8KTL-3PH, HYD 6KTL-3PH and HYD 5KTL-3PH since it is similar in hardware and just power derated by software.

The test results refer to the test report "PV200302N015-6" issued by Bureau Veritas Shenzhen Co., Ltd.

Dongguan Branch, dated on 2020.08.21.

Scope pictures of the disconnection time

Disconnection at No. 6

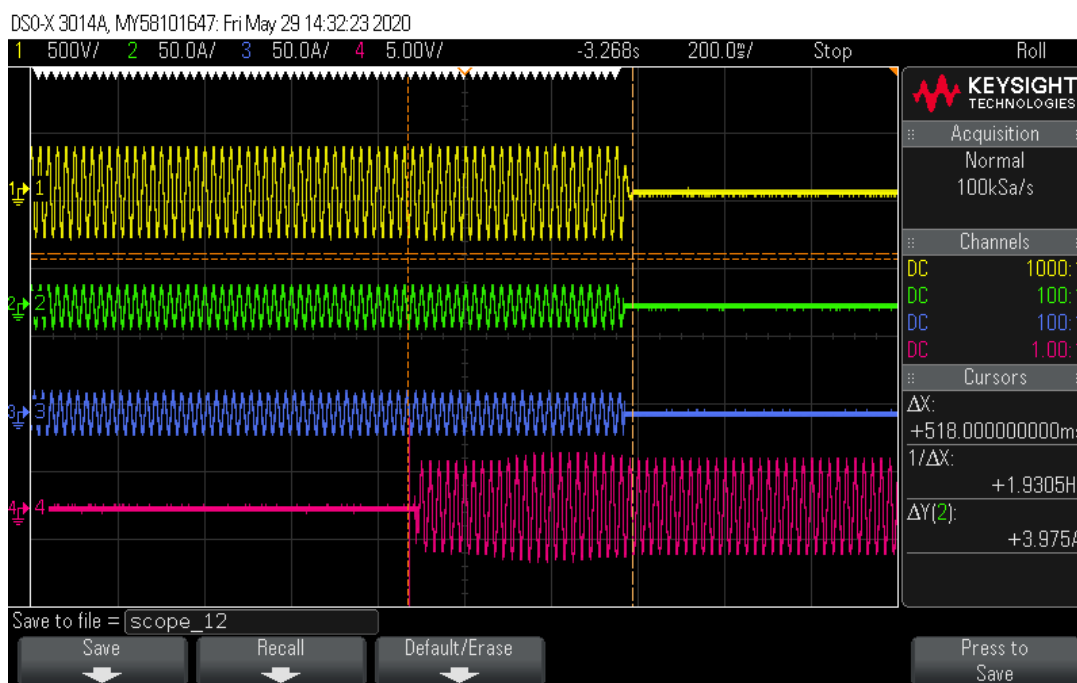

EN 50549-1:2019: Connection and starting to generate electrical power

Clause	Test requirement	Test procedure according standard	Result
4.10.2	Automatic reconnection after tripping	EN 50438, Annex D.3.6	P
4.10.3	Starting to generate electrical power	EN 50438, Annex D.3.6	P

4.10	Connection and starting to generate electrical power		P
4.10.2	Automatic reconnection after tripping		
4.10.3	Starting to generate electrical power (Setting value refer EN 50438 Default setting)		
Setting value	Min. voltage for connected to grid :	196	
	Max. voltage for connected to grid :	253	
	Min. frequency for connected to grid :	49,5	
	Max. frequency for connected to grid (Normal operational start-up) :	50,1	
	Max. frequency for connected to grid (Automatic reconnection after tripping) :	50,2	
	Observation time ($\geq 60s$) :	60	
Test:			
	Voltage conditons		
a) Start up for voltage range	<85% U_n for twice of observation time	>110% U_n for twice of observation time	
Connection:	No connection	No connection	
Limit	No connection allowed		
b) In voltage range at start-up	$\geq 85\% U_n$ within twice setting observation time	$\leq 110\% U_n$ within twice setting observation time	
Reconnection time [s]	64 s	64 s	
Limit:	Connected after setting observation time ($\geq 60s$)		
Gradient:	The maximum occurring active power gradient after connection respectively start generating electrical power is less than the configured maximum active power per minute Max gradient: disable, For recorded gradient see diagram below,		
c) In voltage range after voltage failure	$\geq 85\% U_n$ for twice of setting observation time	$\leq 110\% U_n$ for twice of setting observation time	
Reconnection time [s]	63 s	63 s	
Limit:	Reconnection after setting observation time ($\geq 60s$)		
Gradient:	For adjustable micro generators the maximum occurring active power gradient after connection respectively start generating electrical power is less than the configured maximum active power per minute Max gradient: $10\%P_{E_{max}}/\text{min}$. For non or partly adjustable generators the connection after trip of the interface protection is delayed by a randomised value between 1 min and 10 min. For recorded gradient see diagram below.		

	Frequency conditions	
d) Start up for frequency range	<49,50 Hz for twice of setting observation time	>50,10 Hz for twice of setting observation time
Connection:	No connection	No connection
Limit	No connection allowed	
e) In frequency range at start-up	≥49,50 Hz within twice of setting observation time	≤50,10 Hz within twice of setting observation time
Reconnection time [s]	64 s	63 s
Limit:	Connected after setting delay time(≥60s)	
Gradient:	The maximum occurring active power gradient after connection respectively start generating electrical power is less than the configured maximum active power per minute Max gradient: disable. For recorded gradient see diagram below.	
f) In frequency range after frequency failure	≥49,50 Hz for twice of setting observation time	≤50,20 Hz for twice of setting observation time
Reconnection time [s]	64 s	64 s
Limit:	Reconnection after setting observation time (≥60s)	
Gradient:	For adjustable micro generators the maximum occurring active power gradient after connection respectively start generating electrical power is less than the configured maximum active power per minute Max gradient: 10%P _{E_{max}} /min. For non or partly adjustable generators the connection after trip of the interface protection is delayed by a randomised value between 1 min and 10 min. For recorded gradient see diagram below.	
Test:	<p>Test condition b) and c): voltage within the limits of 85% to 110%U_n.</p> <p>Test condition e): frequency within the limits of 49,50Hz to 50,1Hz.</p> <p>Test condition f): frequency within the limits of 49,50Hz to 50,2Hz.</p> <p>In order to avoid continuous starting and disengaging operations of the interface protection relay, the disengaging value of frequency and voltage functions shall be above 2 % deviating from the operate value.</p> <p>The tests had been performed on the HYD 20KTL-3PH is valid for the HYD 15KTL-3PH, HYD 10KTL-3PH, HYD 8KTL-3PH, HYD 6KTL-3PH and HYD 5KTL-3PH since it is similar in hardware and just power derated by software.</p>	
Assessment criterion:	<p>a) the micro generator connects respectively starts generating electrical power only in the permitted range of voltage and frequency and</p> <p>b) for adjustable micro generators the maximum occurring active power gradient after connection respectively start generating electrical power is less than the configured maximum active power per minute and</p> <p>c) for non or partly adjustable generators the connection after trip of the interface protection is delayed by a randomised value between 1 min and 10 min.</p>	
Note:		



BUREAU
VERITAS

Report No.: PV200302N015-9

The tests had been performed on the HYD 20KTL-3PH is valid for the HYD 15KTL-3PH, HYD 10KTL-3PH, HYD 8KTL-3PH, HYD 6KTL-3PH and HYD 5KTL-3PH since it is similar in hardware and just power derated by software.

The test results refer to the test report "PV200302N015-6" issued by Bureau Veritas Shenzhen Co., Ltd. Dongguan Branch, dated on 2020.08.21.

Graph of the gradual power supply : Test b) for $\geq 85\% U_n$

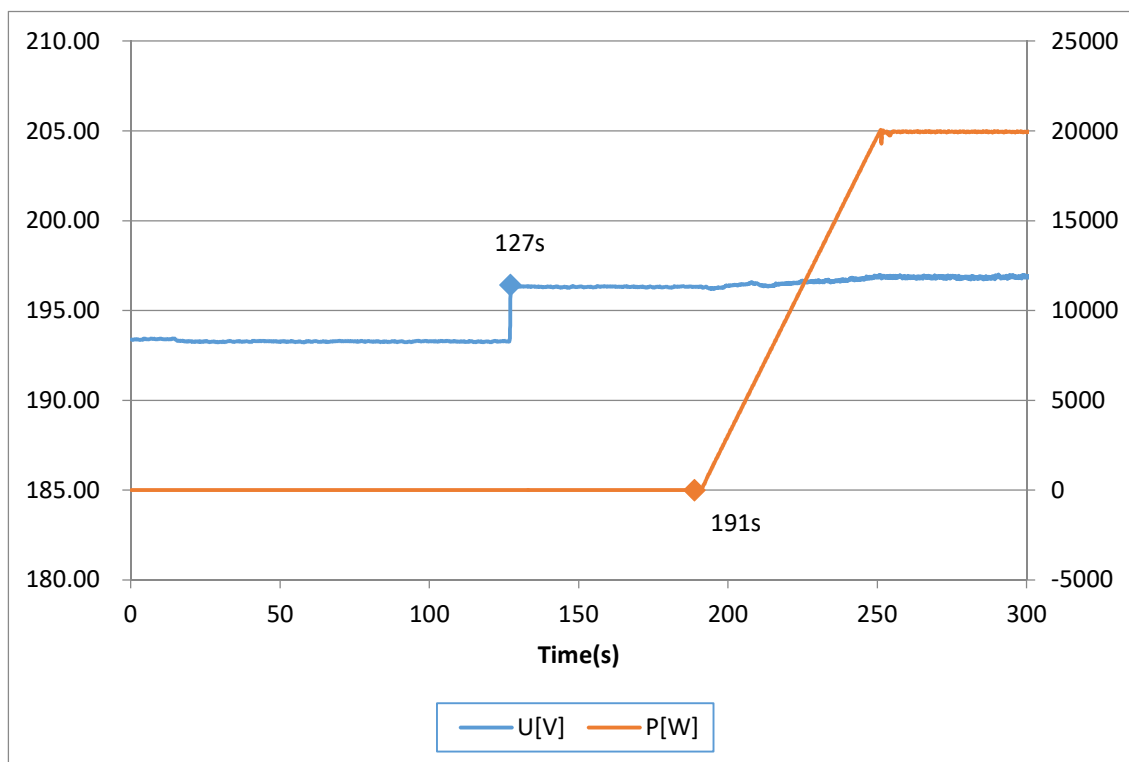

Graph of the gradual power supply : Test b) for $\leq 110\% U_n$

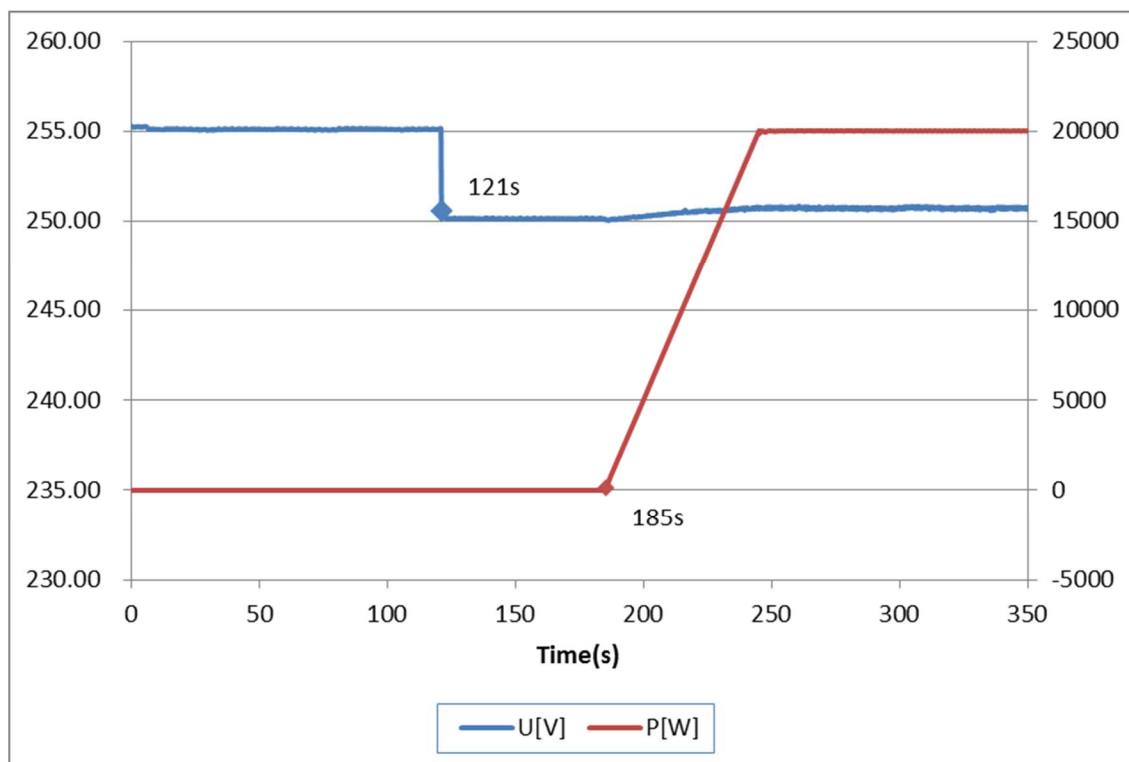

Graph of the gradual power supply : Test c) for $\geq 85\% U_n$

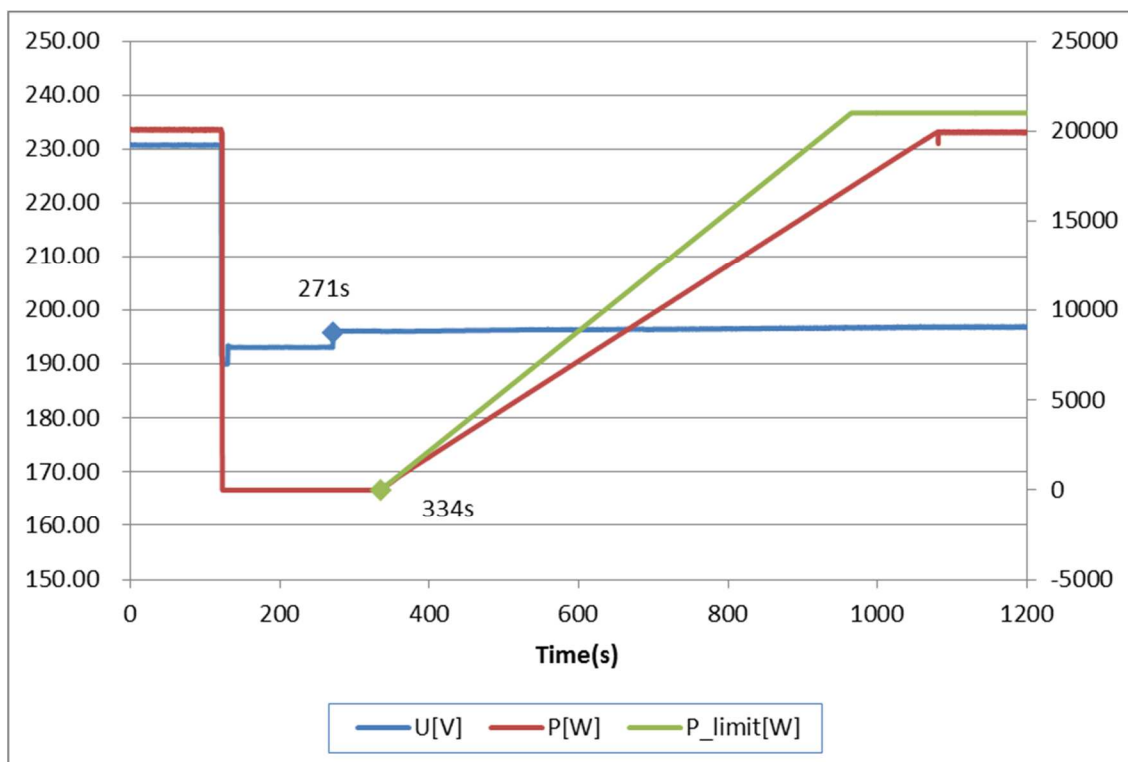

Graph of the gradual power supply : Test c) for $\leq 110\% U_n$

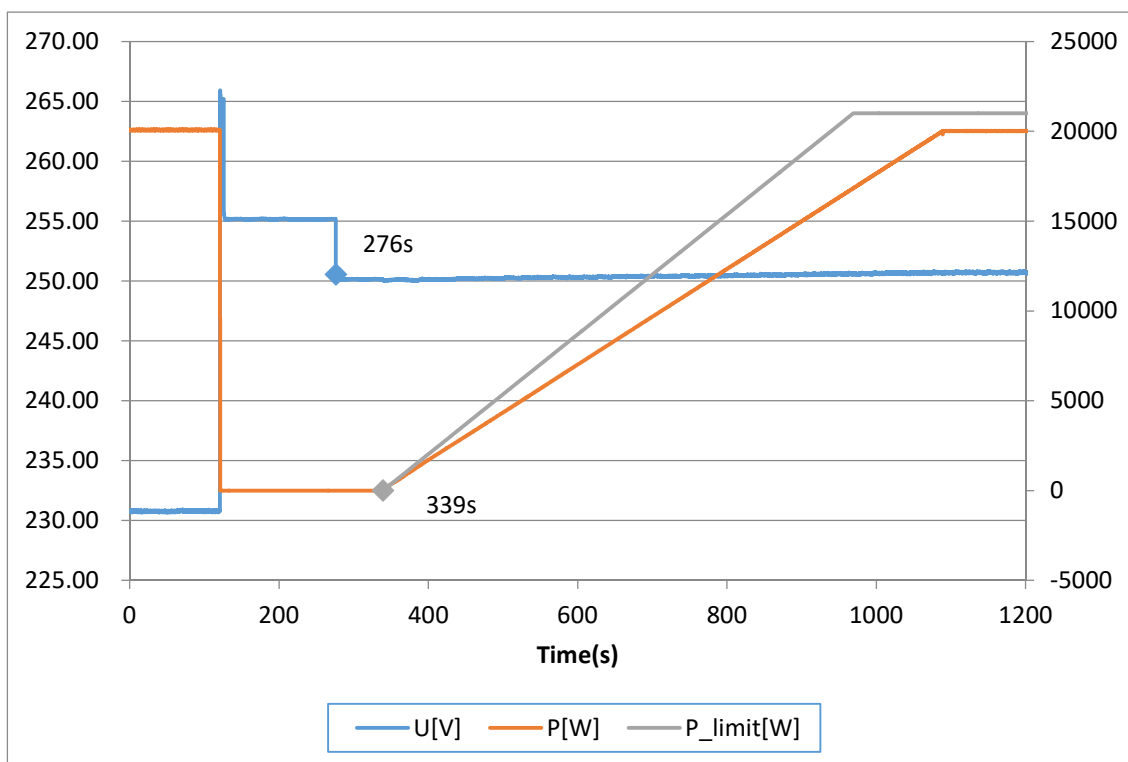

Graph of the gradual power supply : Test d) e) for $\geq 49,50\text{Hz}$

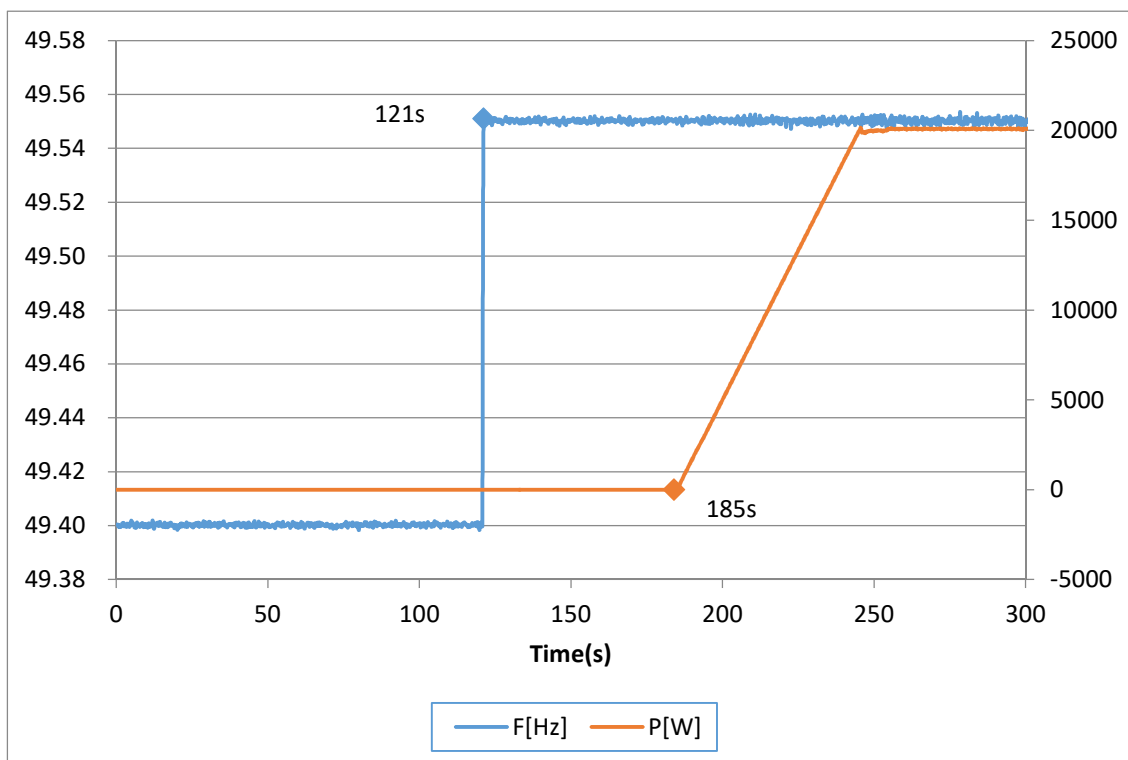

Graph of the gradual power supply : Test e) for $\leq 50,10\text{Hz}$

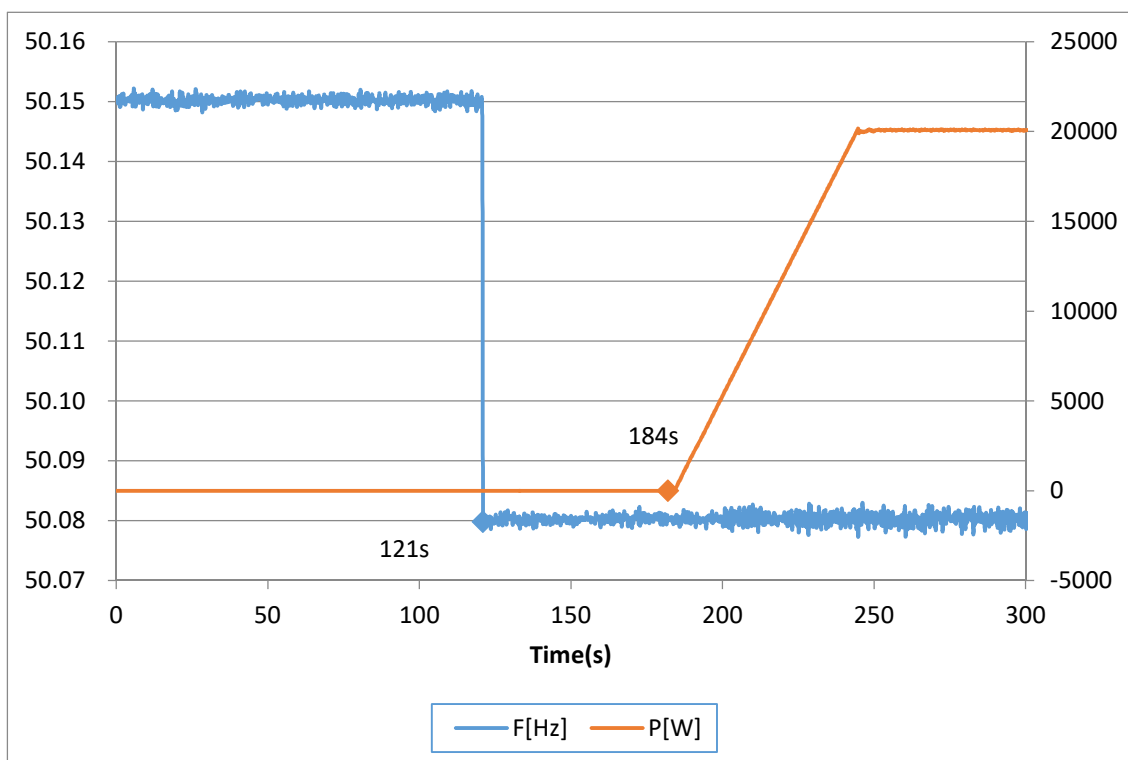

Graph of the gradual power supply : Test f) for $\geq 49,50\text{Hz}$

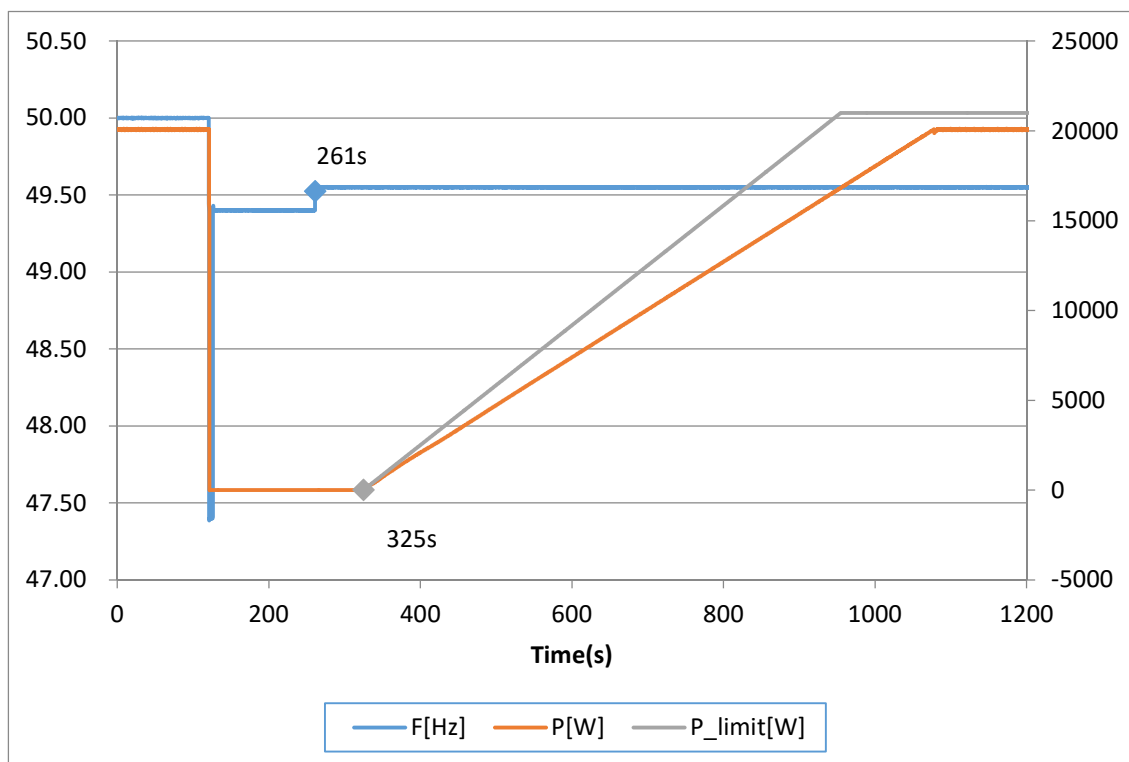

Graph of the gradual power supply : Test f) for $\leq 50,20\text{Hz}$

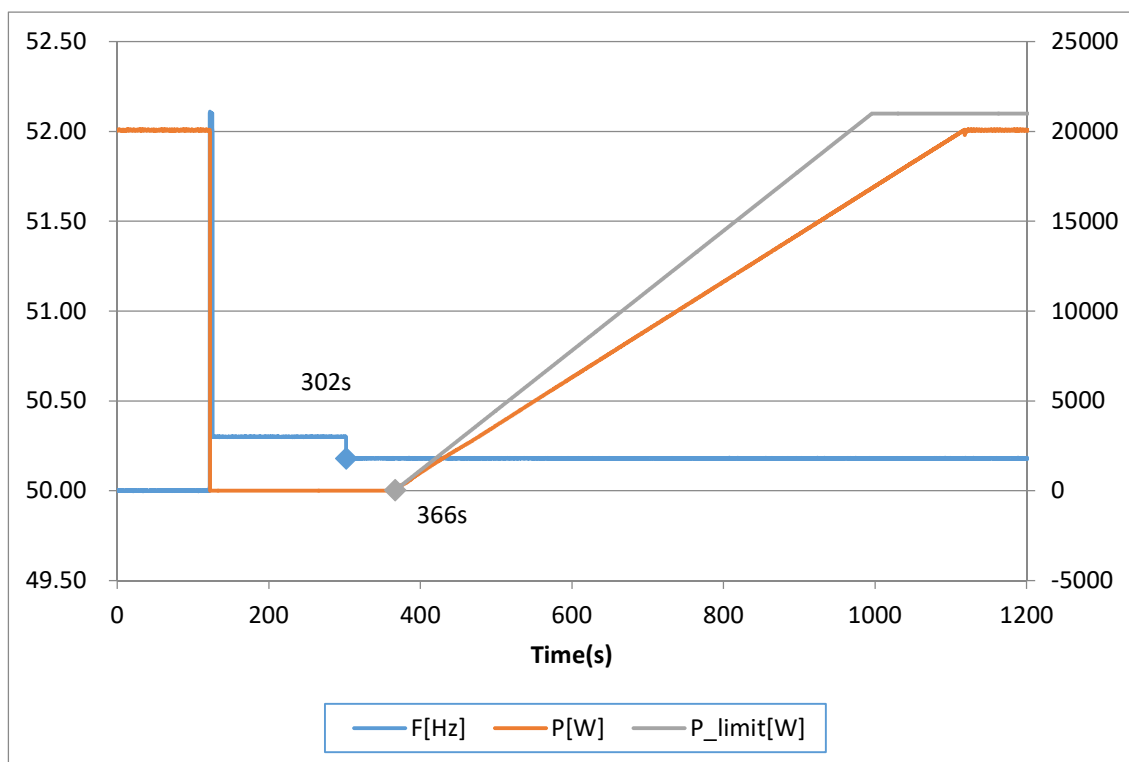

4.10 4.10.2 4.10.3	Connection and starting to generate electrical power		P
	Automatic reconnection after tripping		
	Starting to generate electrical power		
	(Setting value refer default setting for C10/11)		
Setting value	Min. voltage for connected to grid :	196	
	Max. voltage for connected to grid :	253	
	Min. frequency for connected to grid :	49,9	
	Max. frequency for connected to grid (Normal operational start-up) :	50,1	
	Max. frequency for connected to grid (Automatic reconnection after tripping) :	50,1	
	Observation time ($\geq 60s$) :	60	
Test:			
	Voltage conditons		
a) Start up for voltage range	<85% U_n for twice of observation time	>110% U_n for twice of observation time	
Connection:	No connection	No connection	
Limit	No connection allowed		
b) In voltage range at start-up	$\geq 85\% U_n$ within twice setting observation time	$\leq 110\% U_n$ within twice setting observation time	
Reconnection time [s]	61 s	62 s	
Limit:	Connected after setting observation time ($\geq 60s$)		
Gradient:	The maximum occurring active power gradient after connection respectively start generating electrical power is less than the configured maximum active power per minute Max gradient: $20\%P_{E_{max}}/min$. For recorded gradient see diagram below,		
c) In voltage range after voltage failture	$\geq 85\% U_n$ for twice of setting observation time	$\leq 110\% U_n$ for twice of setting observation time	
Reconnection time [s]	63 s	63 s	
Limit:	Reconnection after setting observation time ($\geq 60s$)		
Gradient:	For adjustable micro generators the maximum occurring active power gradient after connection respectively start generating electrical power is less than the configured maximum active power per minute Max gradient: $10\%P_{E_{max}}/min$. For non or partly adjustable generators the connection after trip of the interface protection is delayed by a randomised value between 1 min and 10 min. For recorded gradient see diagram below.		

	Frequency conditions	
d) Start up for frequency range	<49,90 Hz for twice of setting observation time	>50,10 Hz for twice of setting observation time
Connection:	No connection	No connection
Limit	No connection allowed	
e) In frequency range at start-up	≥49,90 Hz within twice of setting observation time	≤50,10 Hz within twice of setting observation time
Reconnection time [s]	63 s	64 s
Limit:	Connected after setting delay time(≥60s)	
Gradient:	<p>The maximum occurring active power gradient after connection respectively start generating electrical power is less than the configured maximum active power per minute Max gradient: 20%P_{E_{max}}/min. For recorded gradient see diagram below.</p>	
f) In frequency range after frequency failure	≥49,90 Hz for twice of setting observation time	≤50,10 Hz for twice of setting observation time
Reconnection time [s]	64 s	63 s
Limit:	Reconnection after setting observation time (≥60s)	
Gradient:	<p>For adjustable micro generators the maximum occurring active power gradient after connection respectively start generating electrical power is less than the configured maximum active power per minute Max gradient: 10%P_{E_{max}}/min. For non or partly adjustable generators the connection after trip of the interface protection is delayed by a randomised value between 1 min and 10 min. For recorded gradient see diagram below.</p>	
<p>Test: Test condition b) and c): voltage within the limits of 85% to 110%U_n. Test condition e): frequency within the limits of 49,90Hz to 50,1Hz. Test condition f): frequency within the limits of 49,90Hz to 50,1Hz.</p> <p>In order to avoid continuous starting and disengaging operations of the interface protection relay, the disengaging value of frequency and voltage functions shall be above 2 % deviating from the operate value.</p> <p>The tests had been performed on the HYD 20KTL-3PH is valid for the HYD 15KTL-3PH, HYD 10KTL-3PH, HYD 8KTL-3PH, HYD 6KTL-3PH and HYD 5KTL-3PH since it is similar in hardware and just power derated by software.</p>		
<p>Assessment criterion:</p> <p>a) the micro generator connects respectively starts generating electrical power only in the permitted range of voltage and frequency and</p> <p>b) for adjustable micro generators the maximum occurring active power gradient after connection respectively start generating electrical power is less than the configured maximum active power per minute and</p> <p>c) for non or partly adjustable generators the connection after trip of the interface protection is delayed by a randomised value between 1 min and 10 min.</p>		

Graph of the gradual power supply : Test b) for $\geq 85\% U_n$

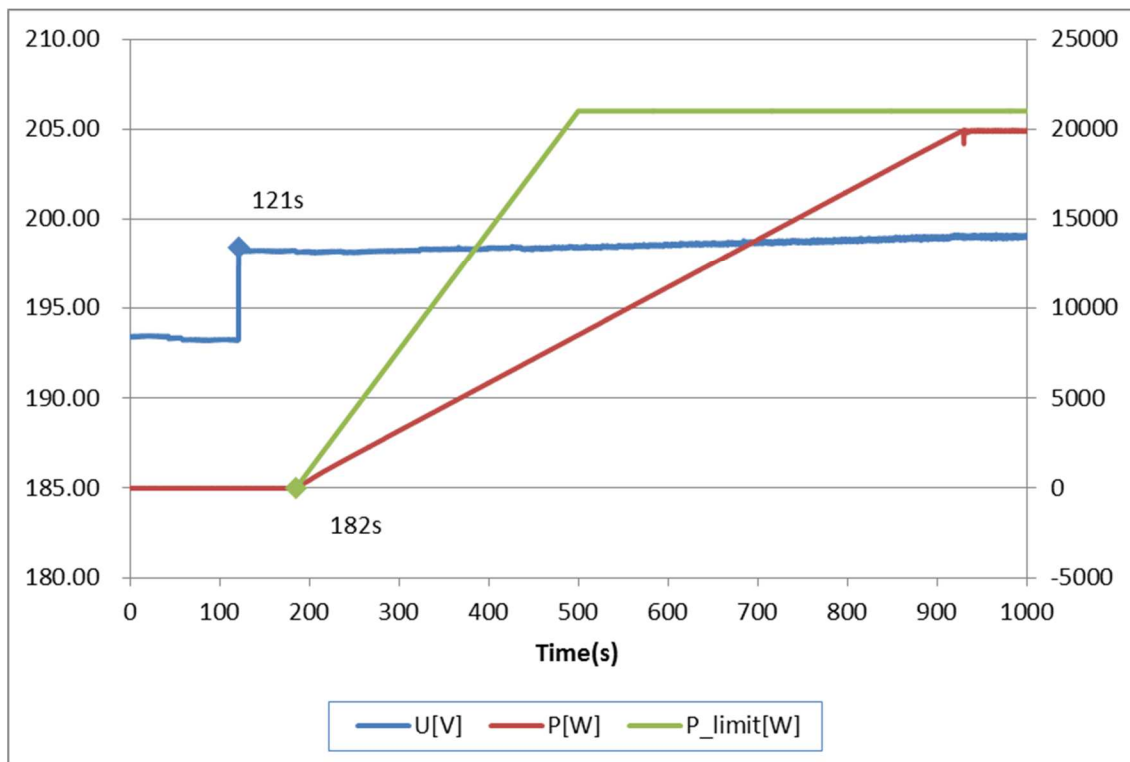

Graph of the gradual power supply : Test b) for $\leq 110\% U_n$

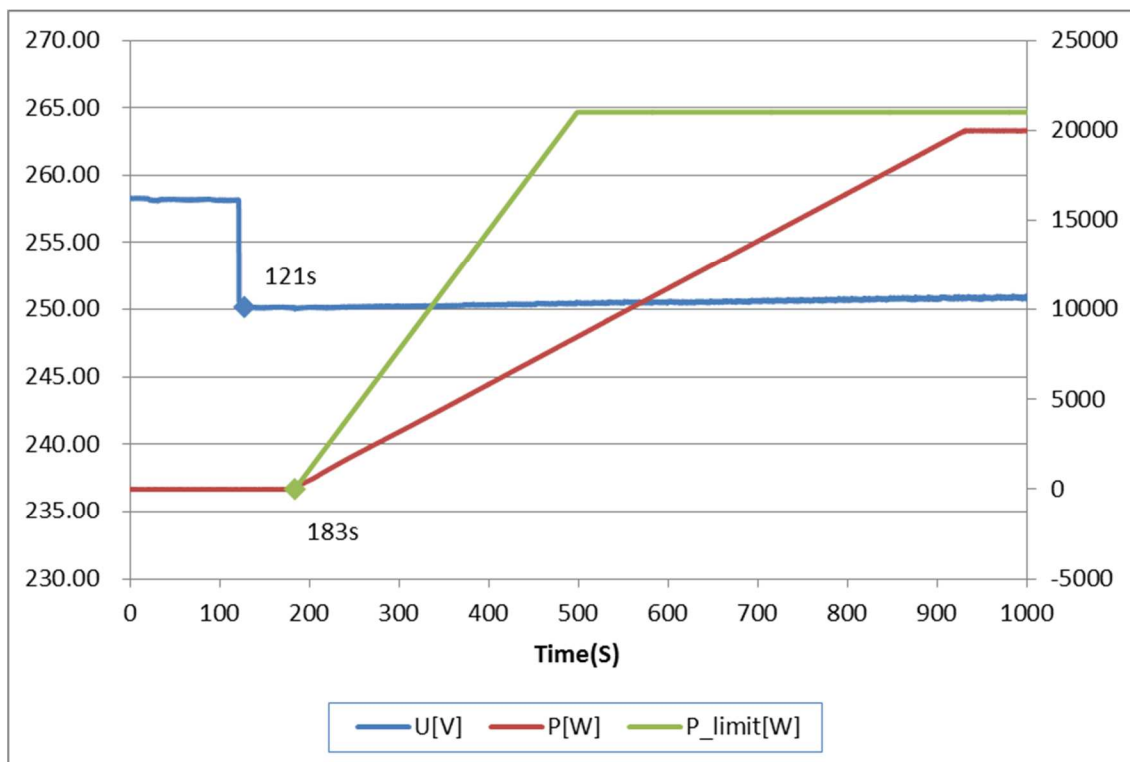

Graph of the gradual power supply : Test c) for $\geq 85\% U_n$

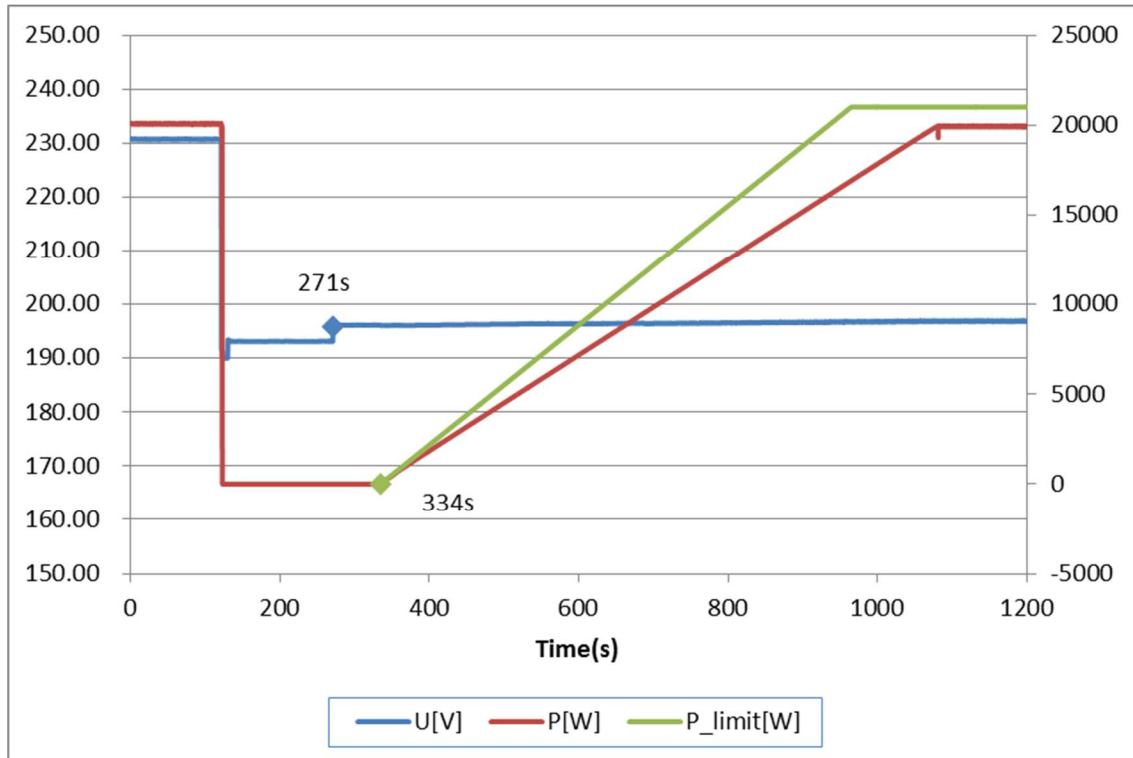

Graph of the gradual power supply : Test c) for $\leq 110\% U_n$

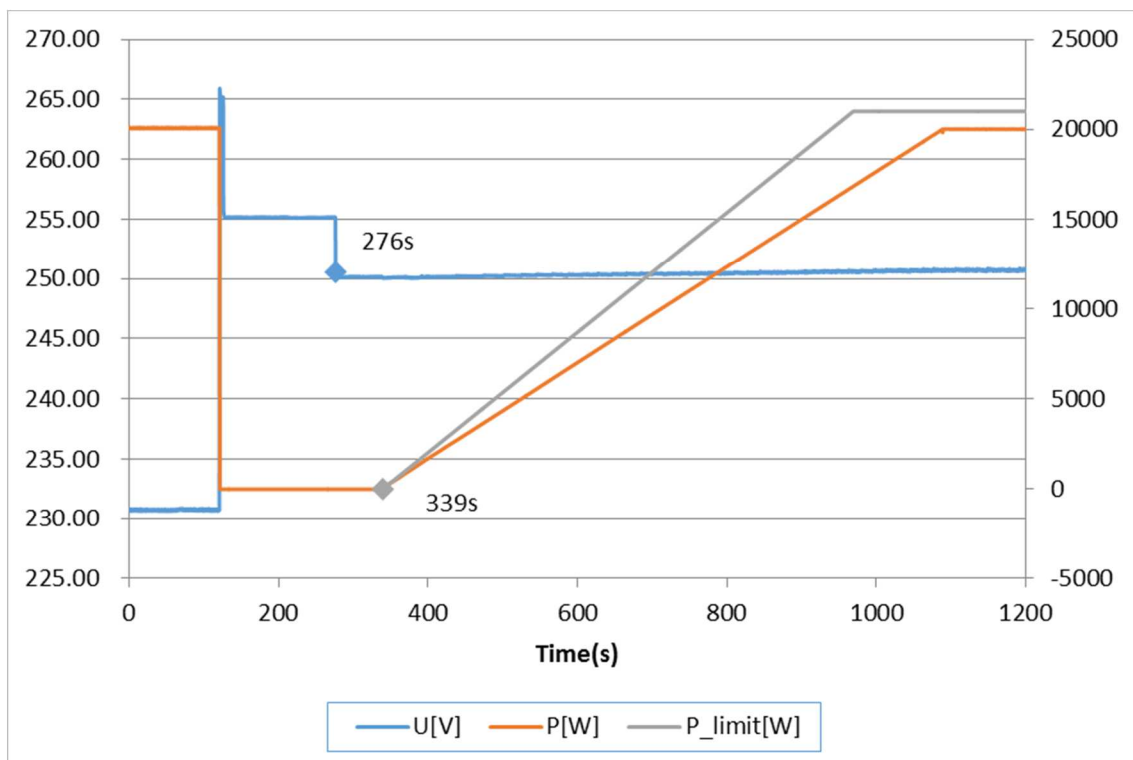

Graph of the gradual power supply : Test d) e) for $\geq 49,90\text{Hz}$

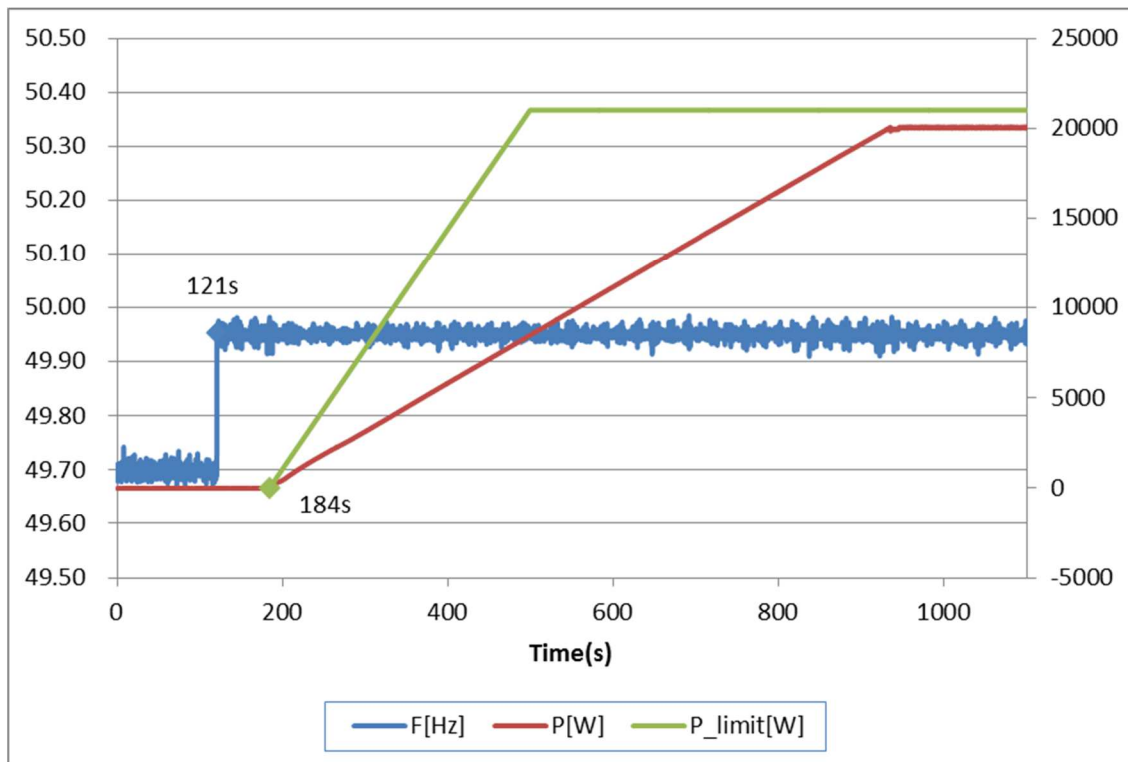

Graph of the gradual power supply : Test e) for $\leq 50,10\text{Hz}$

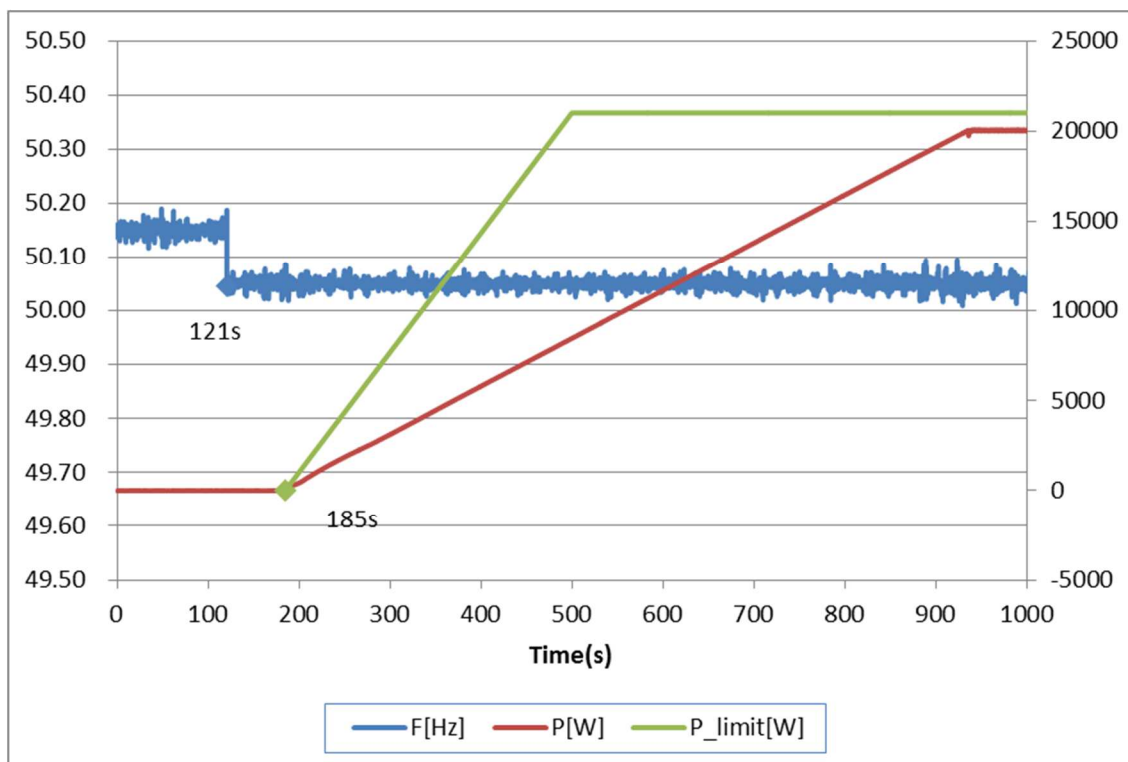

Graph of the gradual power supply : Test f) for $\geq 49,90\text{Hz}$

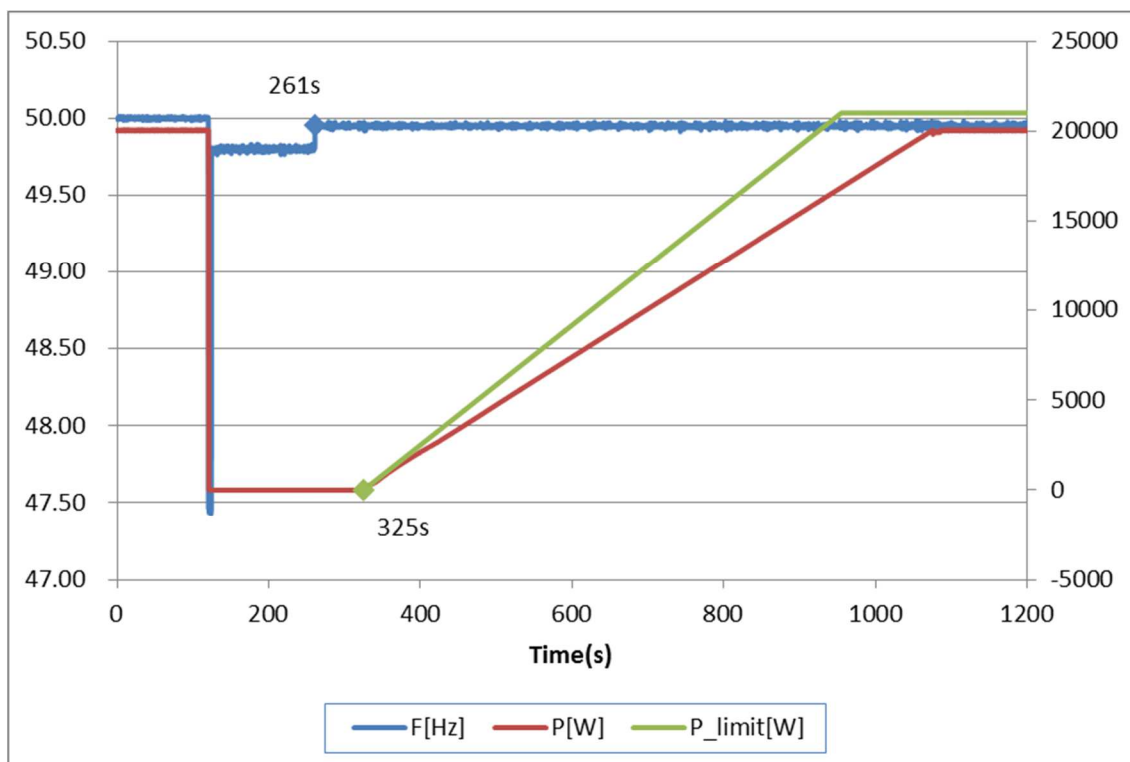

Graph of the gradual power supply : Test f) for $\leq 50,20\text{Hz}$

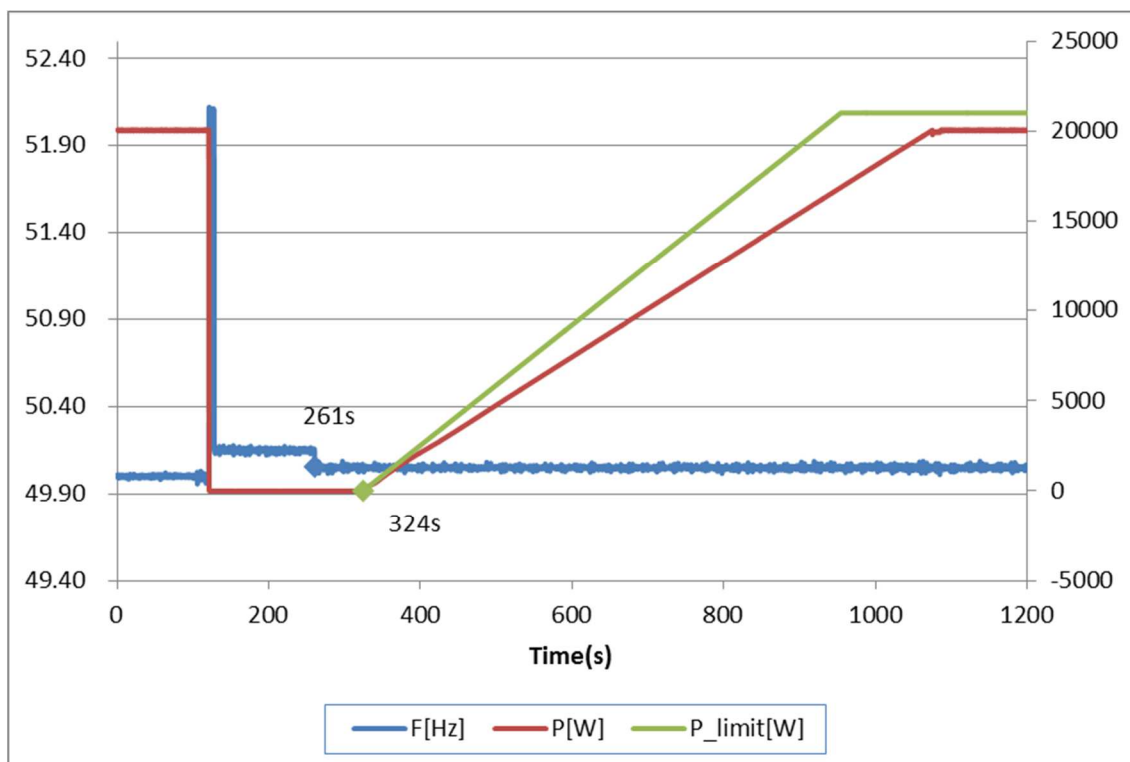

EN 50549-1:2019: Ceasing and reduction of active power on set point

Clause	Test requirement	Test procedure according standard	Result
4.11.1	Ceasing active power	CEI 0-21:2019-04, Annex A.4.3.3.2	P
4.11.2	Reduction of active power on a set point	FGW TG3, Revision 25, clause 4.1.2	P

4.11.1	Ceasing active power	P
---------------	-----------------------------	----------

Operating time of the monitoring device

Test:	Remote tripping signal for the external disconnection
Limit [s]:	5 s
Reaction time of the tripping value [s]:	0,731 s

Note:
 The test method refer to Annex A,4,3,2 of CEI 0-21:2019-04.
 Generating plants shall be equipped with a logic interface (input port) in order to cease active power output within five seconds following an instruction being received at the input port, If required by the DSO, this includes remote operation.
 The tests had been performed on the HYD 20KTL-3PH is valid for the HYD 15KTL-3PH, HYD 10KTL-3PH, HYD 8KTL-3PH, HYD 6KTL-3PH and HYD 5KTL-3PH since it is similar in hardware and just power derated by software.
 The test results refer to the test report "PV200302N015-6" issued by Bureau Veritas Shenzhen Co., Ltd. Dongguan Branch, dated on 2020.08.21.

Graph of Remote trip signal :



4.11.2 Reduction of active power on set point			P
Test result:			
Setpoint power bin [%P _{E_{max}}]	P _{set} [kW]	P ₆₀ [kW]	Deviation [%P _{E_{max}}]
100%	20,000	19,972	-0,140
90%	18,000	17,993	-0,035
80%	16,000	16,002	0,009
70%	14,000	14,011	0,054
60%	12,000	12,017	0,087
50%	10,000	10,025	0,125
40%	8,000	8,033	0,164
30%	6,000	6,040	0,202
20%	4,000	4,030	0,150
10%	2,000	2,076	0,382
3%	0,000	0,638	3,191
	Setpoint power bin [%P _{E_{max}}]	Deviation [%P _{E_{max}}]	
Max. deviation	30%	0,202	
Limit $\Delta P_{E60}/P_{Setpoint}$:	+ 5 % of P_{E_{max}}		
Test:			
The setpoint signal must be reduced from 100% to 10% P _{E_{max}} :			
a) for adjustable PGUs in increments of 10% P _{E_{max}} , 1 minute must elapse after every change to the setpoint setting so that the PGU can settle at the new setpoint, Then the active power of the PGU must be measured as a 1-min mean value.			
b) For all other PGUs, in line with their adjustable steps, 5 minutes must elapse after the setpoint setting is changed so that the PGU can settle at the new setpoint, Then the active power of the PGU must be measured as a 1-min mean value.			
Assessment criterion:			
a) for adjustable PGUs:			
- no network disconnection			
- the active power value does not exceed the setpoint by more than 5% P _{E_{max}}			
- the setting time determined this way is ≤ 1 min			
b) For all other PGUs:			
- the active power value does not exceed the setpoint by more than 5% P _{E_{max}} or			
- the setpoint is fallen below within 5 minutes or the PGU has switched off			

Note:

The setting time is ≤ 1 min. See below "Graph of the setting accuracy".

The tests had been performed on the HYD 20KTL-3PH is valid for the HYD 15KTL-3PH, HYD 10KTL-3PH, HYD 8KTL-3PH, HYD 6KTL-3PH and HYD 5KTL-3PH since it is similar in hardware and just power derated by software.

The test results refer to the test report "PV200302N015-6" issued by Bureau Veritas Shenzhen Co., Ltd. Dongguan Branch, dated on 2020.08.21.

Graph of active power on set point

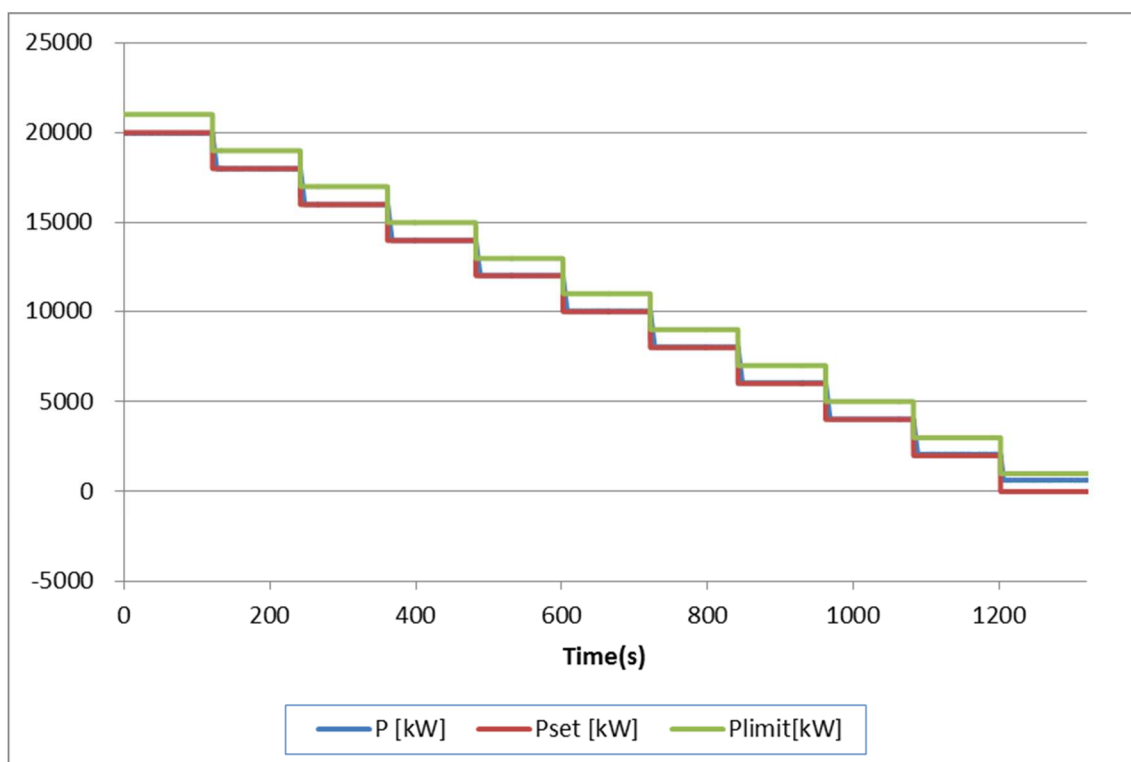

EN 50549-1:2019

Clause	Test requirement	Test procedure according standard	Result
4.13	Requirements regarding single fault tolerance of interface protection system and interface switch	VDE V 0124-100:2019-02 (Draft), clause 5.5.2	P

4.13 Requirements regarding single fault tolerance of interface protection system and interface switch								P
Component No.	Fault	Test condition		Test time	Fuse No.	Fault condition		Result
		AC	DC			AC	DC	
Relay defect RL1 pin4-pin3	Short before start up	230V 0,05A	850V 0,10A	10min.	--	230V 0,05A	850V 0,10A	Indicate Relay fault,error code"ID41"(RelayFail). Do not connect to AC mainsn. No damage,no hazards.
Relay defect RL2 pin4-pin3	Short before start up	230V 0,05A	850V 0,10A	10min.	--	230V 0,05A	850V 0,10A	Indicate Relay fault,error code"ID41"(RelayFail). Do not connect to AC mainsn. No damage,no hazards.
Relay defect RL3 pin4-pin3	Short before start up	230V 0,05A	850V 0,10A	10min.	--	230V 0,05A	850V 0,10A	Indicate Relay fault,error code"ID41"(RelayFail). Do not connect to AC mainsn. No damage,no hazards.
Relay defect RL4 pin4-pin3	Short before start up	230V 0,05A	850V 0,10A	10min.	--	230V 0,05A	850V 0,10A	Indicate Relay fault,error code"ID41"(RelayFail). Do not connect to AC mainsn. No damage,no hazards.
Relay defect RL5 pin4-pin3	Short before start up	230V 0,05A	850V 0,10A	10min.	--	230V 0,05A	850V 0,10A	Indicate Relay fault,error code"ID41"(RelayFail). Do not connect to AC mainsn. No damage,no hazards.
Relay defect RL6 pin4-pin3	Short before start up	230V 0,05A	850V 0,10A	10min.	--	230V 0,05A	850V 0,10A	Indicate Relay fault,error code"ID41"(RelayFail). Do not connect to AC mainsn. No damage,no hazards.
Grid voltage monitoring R137	Open	230V 16,0A	850V 25,0A/ 25,0A	10min.	--	230V 0,05A	850V 0,10A	Output a.c. relays operated, disconnected with grid. error code"ID02"(GridUVP). Do not connect to AC mainsn. No damage,no hazards.
Grid voltage monitoring R 140	Short	230V 16,0A	850V 25,0A/ 25,0A	10min.	--	230V 0,05A	850V 0,10A	Output a.c. relays operated, disconnected with grid. error code"ID01"(GridOVP). Do not connect to AC mainsn. No damage,no hazards.

Component No.	Fault	Test condition		Test time	Fuse No,	Fault condition		Result
		AC	DC			AC	DC	
Grid voltage monitoring R157	Open	230V 16,0A	850V 25,0A/ 25,0A	10min.	--	230V 0,05A	850V 0,10A	Output a.c. relays operated, disconnected with grid. error code "ID02"(GridUVP). Do not connect to AC mainsn. No damage,no hazards.
Grid voltage monitoring R 159	Short	230V 16,0A	850V 25,0A/ 25,0A	10min.	--	230V 0,05A	850V 0,10A	Output a.c. relays operated, disconnected with grid. error code "ID01"(GridOVP). Do not connect to AC mainsn. No damage,no hazards.
Grid voltage monitoring R152	Open	230V 16,0A	850V 25,0A/ 25,0A	10min.	--	230V 0,05A	850V 0,10A	Output a.c. relays operated, disconnected with grid. error code "ID02"(GridUVP). Do not connect to AC mainsn. No damage,no hazards.
Grid voltage monitoring R 155	Short	230V 16,0A	850V 25,0A/ 25,0A	10min.	--	230V 0,05A	850V 0,10A	Output a.c. relays operated, disconnected with grid. error code "ID01"(GridOVP). Do not connect to AC mainsn. No damage,no hazards.
Grid voltage monitoring R147	Open	230V 16,0A	850V 25,0A/ 25,0A	10min.	--	230V 0,05A	850V 0,10A	Output a.c. relays operated, disconnected with grid. error code "ID02"(GridUVP). Do not connect to AC mainsn. No damage,no hazards.
Grid voltage monitoring R 149	Short	230V 16,0A	850V 25,0A/ 25,0A	10min.	--	230V 0,05A	850V 0,10A	Output a.c. relays operated, disconnected with grid. error code "ID01"(GridOVP). Do not connect to AC mainsn. No damage,no hazards.

Component No.	Fault	Test condition		Test time	Fuse No,	Fault condition		Result
		AC	DC			AC	DC	
RCMU detect defect R 8	Open	230V 16,0A	850V 25,0A/ 25,0A	10min.	--	230V 0,05A	850V 0,10A	Indicate GFCI fault,error code"ID21"(GFCIDevice Fault(DC), ID22"(GFCIDeviceFault(AC).Do not connect to AC mainsn.No damage,no hazards.
RCMU detect defect C171	Short	230V 16,0A	850V 25,0A/ 25,0A	10min.	--	230V 0,05A	850V 0,10A	Indicate GFCI fault, error code"ID21"(GFCIDevice Fault(DC), "ID22"(GFCIDeviceFault(AC). Do not connect to AC mainsn. No damage,no hazards.
RCMU detect defect R 246	Short	230V 16,0A	850V 25,0A/ 25,0A	10min.	--	230V 0,05A	850V 0,10A	Indicate GFCI fault,error code"ID21"(GFCIDevice Fault(DC), "ID22"(GFCIDeviceFault(AC). Do not connect to AC mainsn. No damage,no hazards.
RCMU detect defect R 244	Open	230V 16,0A	850V 25,0A/ 25,0A	10min.	--	230V 0,05A	850V 0,10A	Indicate GFCI fault,error code"ID29"(ConsistentFault_GFCI, The GFCI sampling value between the master DSP and slave DSP is not consistent). Do not connect to AC mainsn. No damage,no hazards.
RCMU detect defect R 249	Open	230V 16,0A	850V 25,0A/ 25,0A	10min.	--	230V 0,05A	850V 0,10A	Indicate GFCI fault,error code"ID29"(ConsistentFault_GFCI, The GFCI sampling value between the master DSP and slave DSP is not consistent). Do not connect to AC mainsn. No damage,no hazards.
RCMU detect defect C551	Short	230V 16,0A	850V 25,0A/ 25,0A	10min.	--	230V 0,05A	850V 0,10A	Indicate GFCI fault,error code"ID29"(ConsistentFault_GFCI, The GFCI sampling value between the master DSP and slave DSP is not consistent). Do not connect to AC mainsn. No damage,no hazards.

Component No.	Fault	Test condition		Test time	Fuse No,	Fault condition		Result
		AC	DC			AC	DC	
RCMU detect defect R 920	Open	230V 16,0A	850V 25,0A/ 25,0A	10min.	--	230V 0,05A	850V 0,10A	Indicate GFCI fault,error code"ID29"(ConsistentFault_GFCI, The GFCI sampling value between the master DSP and slave DSP is not consistent). Do not connect to AC mainsn. No damage,no hazards.
Current sensor defect C10	Short	230V 16,0A	850V 25,0A/ 25,0A	10min.	--	230V 0,05A	850V 0,10A	Indicate DCI fault,error code"ID18"(HwADFaultDCI). Do not connect to AC mainsn. No damage,no hazards.
Current sensor defect C 51	Short	230V 16,0A	850V 25,0A/ 25,0A	10min.	--	230V 0,05A	850V 0,10A	Indicate DCI fault,error code"ID18"(HwADFaultDCI). Do not connect to AC mainsn. No damage,no hazards.
Current sensor defect C102	Short	230V 16,0A	850V 25,0A/ 25,0A	10min.	--	230V 0,05A	850V 0,10A	Indicate DCI fault,error code"ID18"(HwADFaultDCI). Do not connect to AC mainsn. No damage,no hazards.
Current sensor defect R 57	Open	230V 16,0A	850V 25,0A/ 25,0A	10min.	--	230V 0,05A	850V 0,10A	Indicate Grid current fault,error code"ID17"(HwADFaultGrid). Do not connect to AC mainsn. No damage,no hazards.
Current sensor defect R 166	Open	230V 16,0A	850V 25,0A/ 25,0A	10min.	--	230V 0,05A	850V 0,10A	Indicate DCI fault,error code"ID18"(HwADFaultDCI). Do not connect to AC mainsn. No damage,no hazards.
Grid voltage monitoring R109	Open	230V 16,0A	850V 25,0A/ 25,0A	10min.	--	230V 16,0A	850V 25,0A/ 25,0A	No fault. no damage.Offline –DCV is wrong.
Grid voltage monitoring R109	Short	230V 16,0A	850V 25,0A/ 25,0A	10min.	--	230V 16,0A	850V 25,0A/ 25,0A	No fault.no damage.Offline –DCV is wrong.

Component No.	Fault	Test condition		Test time	Fuse No,	Fault condition		Result
		AC	DC			AC	DC	
Grid voltage monitoring R203	Short	230V 16,0A	850V 25,0A/ 25,0A	10min.	--	230V 0,05A	850V 0,10A	Indicate Grid voltage fault,error code "ID19"(HwADFaultVGrid(DC)), "ID20"(HwADFaultVGrid(AC)). Do not connect to AC mainsn. No damage,no hazards.
Grid voltage monitoring R240	Short	230V 16,0A	850V 25,0A/ 25,0A	10min.	--	230V 0,05A	850V 0,10A	Indicate Grid voltage fault,error code "ID19"(HwADFaultVGrid(DC)), "ID20"(HwADFaultVGrid(AC)). Do not connect to AC mainsn. No damage,no hazards.
Grid voltage monitoring C541	Short	230V 16,0A	850V 25,0A/ 25,0A	10min.	--	230V 0,05A	850V 0,10A	Indicate Grid voltage fault,error code"ID20"(HwADFaultV Grid(AC)). Do not connect to AC mainsn. No damage,no hazards.
Grid voltage monitoring C539	Short	230V 16,0A	850V 25,0A/ 25,0A	10min.	--	230V 0,05A	850V 0,10A	Indicate Grid voltage fault,error code"ID20"(HwADFaultV Grid(AC)). Do not connect to AC mainsn. No damage,no hazards.
Grid voltage monitoring C540	Short	230V 16,0A	850V 25,0A/ 25,0A	10min.	--	230V 0,05A	850V 0,10A	Indicate Grid voltage fault,error code"ID20"(HwADFaultV Grid(AC)). Do not connect to AC mainsn. No damage,no hazards.
Grid voltage monitoring R904	Open	230V 16,0A	850V 25,0A/ 25,0A	10min.	--	230V 0,05A	850V 0,10A	Indicate Grid voltage fault,error code"ID19"(HwADFaultV Grid(DC)). Do not connect to AC mainsn. No damage,no hazards.
Grid voltage monitoring R905	Open	230V 16,0A	850V 25,0A/ 25,0A	10min.	--	230V 0,05A	850V 0,10A	Indicate Grid voltage fault,error code"ID19"(HwADFaultV Grid(DC)). Do not connect to AC mainsn. No damage,no hazards.
Grid voltage monitoring R906	Open	230V 16,0A	850V 25,0A/ 25,0A	10min.	--	230V 0,05A	850V 0,10A	Indicate Grid voltage fault,error code"ID19"(HwADFaultV Grid(DC)). Do not connect to AC mainsn. No damage,no hazards.

Component No.	Fault	Test condition		Test time	Fuse No,	Fault condition		Result
		AC	DC			AC	DC	
ISO detect defect R 132	Short before start-up	230V 0,05A	850V 0,10A	10min.	--	230V 0,05A	850V 0,10A	Indicate ISO fault,error code"ID42"(PvIsoFault). Do not connect to AC mainsn. No damage,no hazards.
ISO detect defect R 77	Short before start-up	230V 0,05A	850V 0,10A	10min.	--	230V 0,05A	850V 0,10A	Indicate ISO fault,error code"ID42"(PvIsoFault). Do not connect to AC mainsn. No damage,no hazards.
ISO detect defect R 125	Short before start-up	230V 0,05A	850V 0,10A	10min.	--	230V 0,05A	850V 0,10A	Indicate ISO fault,error code"ID42"(PvIsoFault). Do not connect to AC mainsn. No damage,no hazards.
ISO detect defect R 136	Short before start-up	230V 0,05A	850V 0,10A	10min.	--	230V 0,05A	850V 0,10A	Indicate ISO fault,error code"ID42"(PvIsoFault). Do not connect to AC mainsn. Q14 damage,no hazards.
ISO detect defect C705	Short before start-up	230V 0,05A	850V 0,10A	10min.	--	230V 0,05A	850V 0,10A	Indicate ISO fault,error code"ID42"(PvIsoFault). Do not connect to AC mainsn. No damage,no hazards.
ISO detect defect C630	Short before start-up	230V 0,05A	850V 0,10A	10min.	--	230V 0,05A	850V 0,10A	Indicate ISO fault,error code"ID42"(PvIsoFault). Do not connect to AC mainsn. No damage,no hazards.
DSP communication defect R481	Short	230V 16,0A	850V 25,0A/ 25,0A	10min.	--	230V 0,05A	850V 0,10A	Indicate SCI fault,error code"ID154"(SciCommLose(AC)). Do not connect to AC mainsn. Q26 damage,no hazards.
DSP communication defect R484	Short	230V 16,0A	850V 25,0A/ 25,0A	10min.	--	230V 0,05A	850V 0,10A	Indicate SCI fault,error code"ID153"(SciCommLose(DC)). Do not connect to AC mainsn. Q25 damage,no hazards.
Loss of control C287	Short	230V 16,0A	850V 25,0A/ 25,0A	10min.	--	230V 0,05A	850V 0,10A	Output a.c. relays operated, disconnected with grid,no error code. Do not connect to AC mainsn. No damage.No hazards.

Component No.	Fault	Test condition		Test time	Fuse No,	Fault condition		Result
		AC	DC			AC	DC	
Loss of control C277	Short	230V 16,0A	850V 25,0A/ 25,0A	10min.	--	230V 0,05A	850V 0,10A	Output a.c. relays operated, disconnected with grid,error code"ID33,ID34,ID153,ID154"(SpiCommLose DC/AC, SciCommLose DC/AC). Do not connect to AC mainsn. No damage.No hazards.
Loss of control C548	Short	230V 16,0A	850V 25,0A/ 25,0A	10min.	--	230V 0,05A	850V 0,10A	Output a.c. relays operated, disconnected with grid,error code"ID33,ID34,ID153,ID154"(SpiCommLose DC/AC, SciCommLose DC/AC). Do not connect to AC mainsn. No damage.No hazards.
Loss of control C679	Short	230V 16,0A	850V 25,0A/ 25,0A	10min.	--	230V 0,05A	850V 0,10A	Output a.c. relays operated, disconnected with grid,error code"ID33,ID34,ID153,ID154"(SpiCommLose DC/AC, SciCommLose DC/AC). Do not connect to AC mainsn. No damage.No hazards.

The errors in the control circuit simulate that the safety is even under one error ensured.

Addendum – Shutdown device

Each active phase can be switched, (L and N)

Yes

If no galvanic separation between AC and DC (PV):
Two relays in series on each active phase are necessary to fulfil the basic insulation or simple separation based on the PV working voltage,

Two relays in series on each active phase

Note:

s-c: short circuit; o-c: open circuit

before start-up

The errors in the control circuit simulate that the safety is even ensured during a single fault,

The tests had been performed on the HYD 20KTL-3PH is valid for the HYD 15KTL-3PH, HYD 10KTL-3PH, HYD 8KTL-3PH, HYD 6KTL-3PH and HYD 5KTL-3PH since it is similar in hardware and just power derated by software.

The test result refer to the original test report PVDE200320N031 issued by Bureau Veritas Shenzhen Co., Ltd. Dongguan Branch, dated on 2020-07-31.



Report No.: PV200302N015-9

Annex 1

Pictures of the unit

The full pictures refer to PHOTO DOCUMENT

Project No.: 200320N031

Date: 20200731

Front enclosure-view
(HYD 5KTL-3PH, HYD 6KTL-3PH, HYD 8KTL-3PH, HYD 10KTL-3PH, HYD 15KTL-3PH, HYD 20KTL-3PH)



Bottom enclosure-view
(HYD 5KTL-3PH, HYD 6KTL-3PH, HYD 8KTL-3PH, HYD 10KTL-3PH, HYD 15KTL-3PH, HYD 20KTL-3PH)



Rear enclosure-view





Report No.: PV200302N015-9

Annex No. 2

Test Equipment list

Date(s) of performance test: 2020-03-02 to 2020-08-21

Equipment	Internal No,	Manufacturer	Type	Serial No.	Last Calibration
AC Source	A7040019DG	Chroma	61512	61512000439	Monitored by Power Analyzer
	A7040020DG	Chroma	61512	61512000438	
DC Simulation Power Supply	A7040016DG	Chroma	62150H-1000S	62150EF00490	
	A7040017DG	Chroma	620028	620028EF00120	
RLC Load	A7150027DG	Qunling	ACLT-3803H	93VOO2869	
Four Channel Digital Phosphor Oscilloscope	SB9146	TEKTRONIX	DP03034	C013936	Mar. 27, 2020
	//	Agilent	DS05014A	MY5007288	Nov. 22, 2019
Eight Channel Digital Phosphor Oscilloscope	A4089017DG	YOKOGAWA	DL850	91N726247	Sep. 24, 2019
Oscilloscope probel	A1490008DG	YOKOGAWA	701901	//	Sep. 20, 2019
	A1490009DG	YOKOGAWA	701901	//	Sep. 20, 2019
	A1490010DG	YOKOGAWA	701901	//	Sep. 20, 2019
Current transducer	A1060007DG	YOKOGAWA	CT200	1130700012	Sep. 12, 2019
	A1060008DG	YOKOGAWA	CT200	1130700017	Sep. 12, 2019
	A1060009DG	YOKOGAWA	CT200	1130700019	Sep. 12, 2019
Power Analyzer	A4080002DG	YOKOGAWA	WT3000	91M210852	Sep. 12, 2019